

PRELIMINARY DATA SHEET



GaAs INTEGRATED CIRCUIT uPG2159T5K

L,S-BAND MINIATURE SPDT SWITCH

DESCRIPTION

The uPG2159T5K is a GaAs MMIC L,S-band SPDT (Single Pole Double Throw) switch designed for mobile phone and the other L,S-band applications.

This device can operate from frequency 0.05GHz to 3.0GHz, with low insertion loss and high isolation

This device is housed in a 6-pin TSSON (Thin Shrink Small Out-line Non-Leaded) package, and is suitable for high-density surface mounting.

FEATURES

- Switch Control Voltage : $V_{cont(H)} = 1.8$ to $3.3V$ (2.7V TYP.)
: $V_{cont(L)} = -0.2$ to $0.2V$ (0V TYP.)
- Low Insertion Loss : $L_{ins1} = 0.20dB$ TYP. @ $f = 0.05$ to $0.5GHz$, $V_{cont(H)} = 2.7V$, $V_{cont(L)} = 0V$
: $L_{ins2} = 0.21dB$ TYP. @ $f = 0.5$ to $1.0GHz$, $V_{cont(H)} = 2.7V$, $V_{cont(L)} = 0V$
: $L_{ins3} = 0.23dB$ TYP. @ $f = 1.0$ to $2.0GHz$, $V_{cont(H)} = 2.7V$, $V_{cont(L)} = 0V$
: $L_{ins4} = 0.25dB$ TYP. @ $f = 2.0$ to $2.5GHz$, $V_{cont(H)} = 2.7V$, $V_{cont(L)} = 0V$
: $L_{ins5} = 0.27dB$ TYP. @ $f = 2.5$ to $3.0GHz$, $V_{cont(H)} = 2.7V$, $V_{cont(L)} = 0V$
- High Isolation : $ISL1 = 27dB$ TYP. @ $f = 0.05$ to $0.5GHz$, $V_{cont(H)} = 2.7V$, $V_{cont(L)} = 0V$
: $ISL2 = 27dB$ TYP. @ $f = 0.5$ to $1.0GHz$, $V_{cont(H)} = 2.7V$, $V_{cont(L)} = 0V$
: $ISL3 = 27dB$ TYP. @ $f = 1.0$ to $2.0GHz$, $V_{cont(H)} = 2.7V$, $V_{cont(L)} = 0V$
: $ISL4 = 27dB$ TYP. @ $f = 2.0$ to $2.5GHz$, $V_{cont(H)} = 2.7V$, $V_{cont(L)} = 0V$
: $ISL5 = 27dB$ TYP. @ $f = 2.5$ to $3.0GHz$, $V_{cont(H)} = 2.7V$, $V_{cont(L)} = 0V$
- Power Handling : $P_{in(1dB)} = +25.5dBm$ TYP. @ $f = 0.5$ to $3.0GHz$, $V_{cont(H)} = 2.7V$, $V_{cont(L)} = 0V$
: $P_{in(0.1dB)} = +22.0dBm$ TYP. @ $f = 0.5$ to $3.0GHz$, $V_{cont(H)} = 2.7V$, $V_{cont(L)} = 0V$
- High-density surface mounting : 6-pin TSSON package (1.0 × 1.0 × 0.37 mm)

APPLICATIONS:

- L,S-band digital cellular or cordless telephone
- W-LAN, Bluetooth™, ZigBee, etc.

ORDERING INFORMATION

Part Number	Order Number	Package	Marking	Supplying Form
uPG2159T5K-E2	uPG2159T5K-E2-A	6-pin plastic TSSON (Pb-Free)	G3	<ul style="list-style-type: none">• Embossed tape 8mm wide• Pin 1, 6 face the perforation side of the tape• Qty 5 kpcs/reel

Remark To order evaluation samples, contact your nearby sales office.
Part number for sample order : uPG2159T5K-A

Caution Observe precautions when handling, because these devices are sensitive to electrostatic discharge.

The information in this document is subject to change without notice. Before using this document, please confirm that this is the latest version.

PIN CONNECTIONS AND INTERNAL BLOCK DIAGRAM

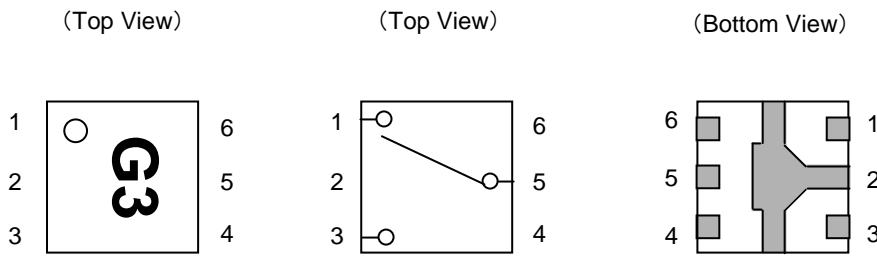

Pin No.	Pin Name
1	OUTPUT1
2	GND
3	OUTPUT2
4	V _{cont2}
5	INPUT
6	V _{cont1}

SW TRUTH TABLE

V _{cont1}	V _{cont2}	INPUT-OUTPUT1	INPUT-OUTPUT2
Low	High	OFF	ON
High	Low	ON	OFF

ASOLUTE MAXIMUM RATINGS (Unless otherwise specified, T_A = +25°C)

Parameter	Symbol	Ratings	Unit
Switch Control Voltage <small>Note1</small>	V _{cont}	+6.0	V
Input Power <small>Note2</small>	P _{in}	+26.0	dBm
Input Power <small>Note3</small>	P _{in}	+8+V _{cont} * 20/3	dBm
Operating Ambient Temperature	T _A	-45 to +85	°C
Storage Temperature	T _{stg}	-55 to +150	°C

Note1 | V_{cont1} - V_{cont2} | ≤ 6.0V

Note2 2.7 ≤ | V_{cont1} - V_{cont2} | ≤ 3.3V

Note3 1.8 ≤ | V_{cont1} - V_{cont2} | ≤ 2.7V

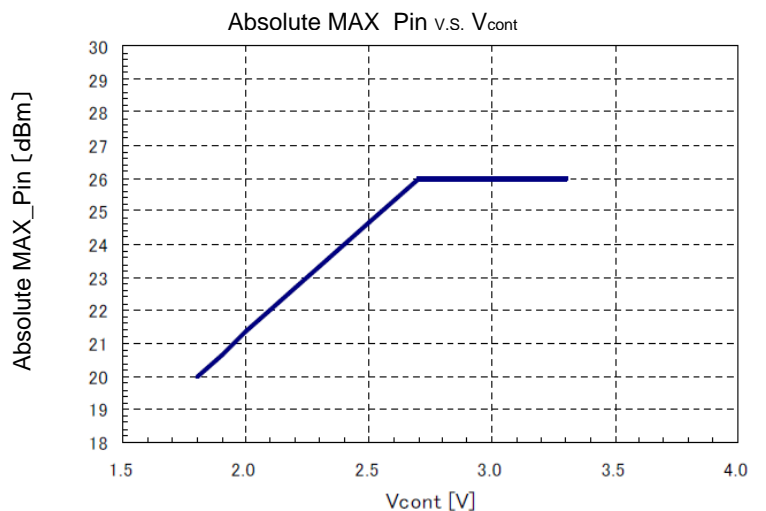

RECOMMENDED OPERATING RANGE (Unless otherwise specified, T_A = +25°C)

Parameter	Symbol	MIN.	TYP.	MAX.	Unit
Switch Control Voltage (H)	V _{cont} (H)	1.8	2.7	3.3	V
Switch Control Voltage (L)	V _{cont} (L)	-0.2	0	0.2	V

ELECTRICAL CHARACTERISTICS1($T_A = +25^\circ\text{C}$, $V_{\text{cont(H)}} = 2.7\text{V}$, $V_{\text{cont(L)}} = 0\text{V}$, DC blocking capacitors = 56pF, Unless otherwise specified)

Parameter	Symbol	Test Conditions	MIN.	TYP.	MAX.	Unit
Insertion Loss1	L _{ins1}	f = 0.05 to 0.5GHz ^{Note1}	-	0.20	0.35	dB
Insertion Loss2	L _{ins2}	f = 0.5 to 1.0GHz	-	0.21	0.35	dB
Insertion Loss3	L _{ins3}	f = 1.0 to 2.0GHz	-	0.23	0.40	dB
Insertion Loss4	L _{ins4}	f = 2.0 to 2.5GHz	-	0.25	0.42	dB
Insertion Loss5	L _{ins5}	f = 2.5 to 3.0GHz	-	0.27	0.45	dB
Isolation1	ISL1	f = 0.05 to 0.5GHz ^{Note1}	24	27	-	dB
Isolation2	ISL2	f = 0.5 to 1.0GHz	24	27	-	dB
Isolation3	ISL3	f = 1.0 to 2.0GHz	24	27	-	dB
Isolation4	ISL4	f = 2.0 to 2.5GHz	24	27	-	dB
Isolation5	ISL5	f = 2.5 to 3.0GHz	24	27	-	dB
Input Return Loss1	RL _{in1}	f = 0.05 to 0.5GHz ^{Note1}	15	20	-	dB
Input Return Loss2	RL _{in2}	f = 0.5 to 3.0GHz	15	20	-	dB
Output Return Loss1	RL _{out1}	f = 0.05 to 0.5GHz ^{Note1}	15	20	-	dB
Output Return Loss2	RL _{out2}	f = 0.5 to 3.0GHz	15	20	-	dB
0.1dB Loss Compression Input Power ^{Note2}	P _{in (0.1dB)}	f = 2.0GHz/2.5GHz	+20.0	+22.0	-	dBm
		f = 0.5 to 3.0GHz	-	+22.0	-	dBm
1dB Loss Compression Input Power ^{Note3}	P _{in (1dB)}	f = 0.5 to 3.0GHz	-	+25.5	-	dBm
2nd Harmonics	2f ₀	f = 2.0GHz/2.5GHz, P _{in} =+10dBm	65	77	-	dBc
3rd Harmonics	3f ₀	f = 2.0GHz/2.5GHz, P _{in} =+10dBm	60	80	-	dBc
Input Intercept Point	IIP ₃	f = 0.5 to 3.0GHz, 2tone 5MHz spacing	-	+49.0	-	dBm
Switch Control Current	I _{cont}		-	0.2	1.0	uA
Switch Control Speed	t _{sw}	50% CTL to 90/10%	-	20	200	ns

Note1. DC blocking capacitors = 1000pF 0.05 to 0.5GHz**Note2.** P_{in (0.1dB)} is the measured input power level when the insertion loss increases 0.1dB more than that of linear range.**Note3.** P_{in (1dB)} is the measured input power level when the insertion loss increases 1dB more than that of linear range.

ELECTRICAL CHARACTERISTICS2

(TA = +25°C, Vcont(H) = 1.8V, Vcont(L) = 0V,DC blocking capacitors = 56pF,Unless otherwise specified)

Parameter	Symbol	Test Conditions	MIN.	TYP.	MAX.	Unit
Insertion Loss6	Lins6	f = 0.05 to 0.5GHz ^{Note1}	-	0.21	0.36	dB
Insertion Loss7	Lins7	f = 0.5 to 1.0GHz	-	0.22	0.37	dB
Insertion Loss8	Lins8	f = 1.0 to 2.0GHz	-	0.24	0.41	dB
Insertion Loss9	Lins9	f = 2.0 to 2.5GHz	-	0.26	0.43	dB
Insertion Loss10	Lins10	f = 2.5 to 3.0GHz	-	0.28	0.46	dB
Isolation6	ISL6	f = 0.05 to 0.5GHz ^{Note1}	23	26	-	dB
Isolation7	ISL7	f = 0.5 to 1.0GHz	23	26	-	dB
Isolation8	ISL8	f = 1.0 to 2.0GHz	23	26	-	dB
Isolation9	ISL9	f = 2.0 to 2.5GHz	23	26	-	dB
Isolation10	ISL10	f = 2.5 to 3.0GHz	23	26	-	dB
Input Return Loss3	RLin3	f = 0.05 to 0.5GHz ^{Note1}	15	20	-	dB
Input Return Loss4	RLin4	f = 0.5 to 3.0GHz	15	20	-	dB
Output Return Loss3	RLout3	f = 0.05 to 0.5GHz ^{Note1}	15	20	-	dB
Output Return Loss4	RLout4	f = 0.5 to 3.0GHz	15	20	-	dB
0.1dB Loss Compression Input Power ^{Note2}	P _{in} (0.1dB)	f = 2.0GHz/2.5GHz	12	+15.5	-	dBm
		f = 0.5 to 3.0GHz	-	+15.5	-	dBm
1dB Loss Compression Input Power ^{Note3}	P _{in} (1dB)	f = 0.5 to 3.0GHz	-	+19.5	-	dBm
Switch Control Current	I _{cont}	RF None	-	0.2	1.0	uA
Switch Control Speed	t _{sw}	50% CTL to 90/10% RF	-	20	200	ns

Note1. DC blocking capacitors = 1000pF 0.05 to 0.5GHz

Note2. P_{in} (0.1dB) is the measured input power level when the insertion loss increases 0.1dB more than that of linear range.

Note3. P_{in} (1dB) is the measured input power level when the insertion loss increases 1dB more than that of linear range.

EVALUATION CIRCUIT

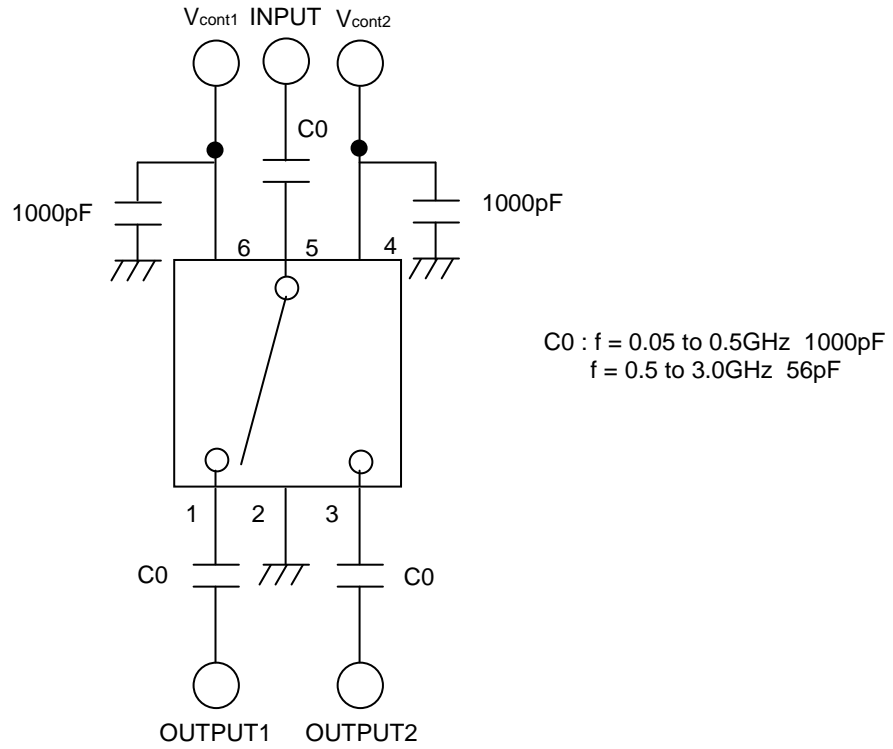

The application circuits and their parameters are for reference only and are not intended for use in actual design-ins.

MOUNTING PAD AND SOLDER MASK LAYOUT DIMENSIONS

6-PIN PLASTIC TSSON (UNIT: mm)

MOUNTING PAD

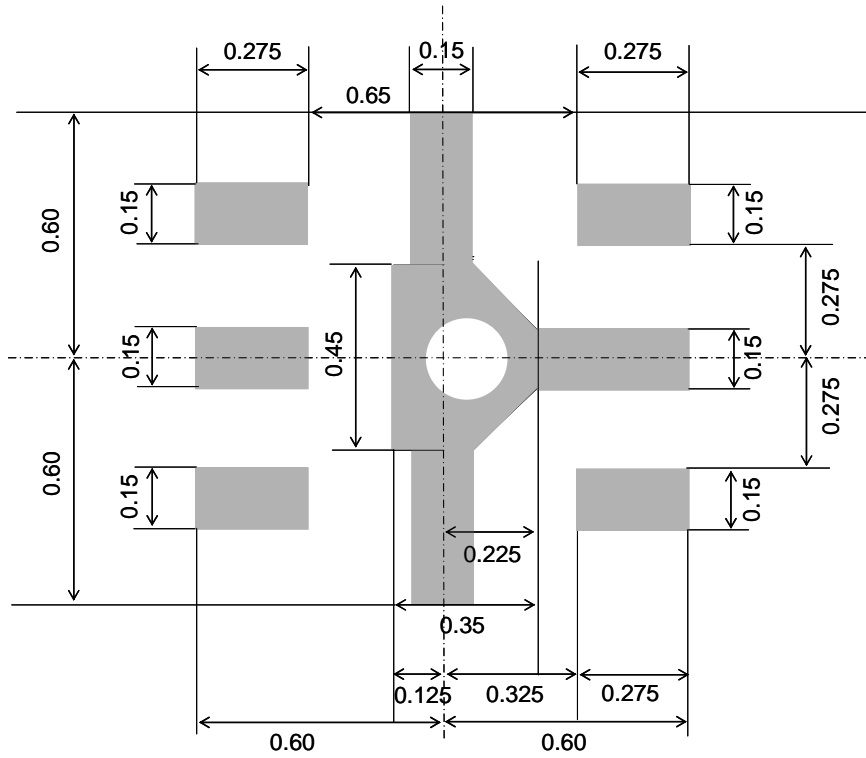

SOLDER MASK

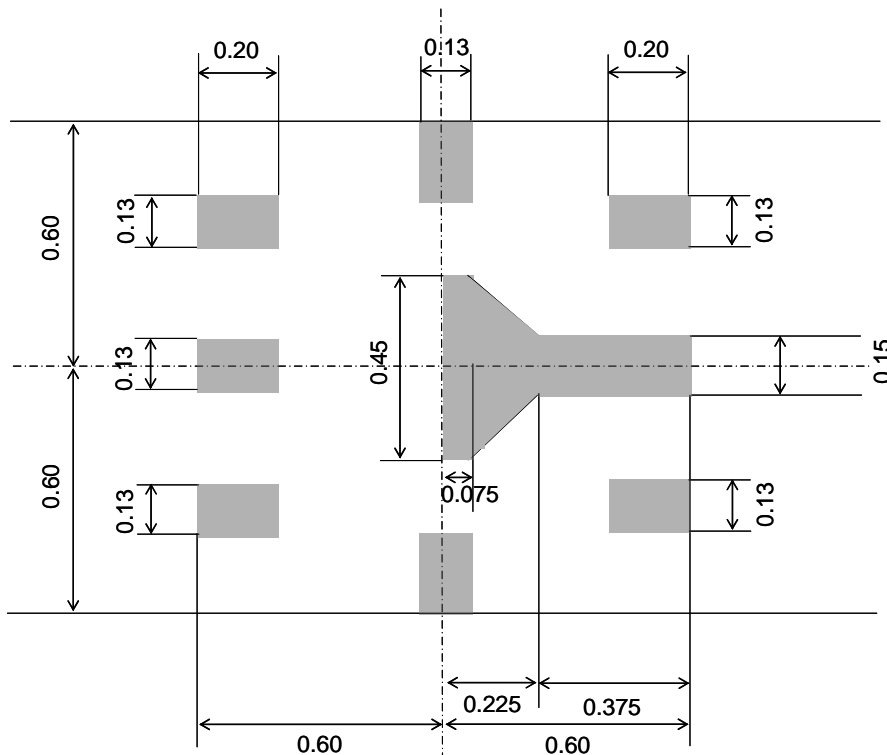

Solder thickness: 0.08 mm

Remark The mounting pad and solder mask layouts in this document are for reference only.

6-PIN TSSOP (UNIT: mm)

(Top View)

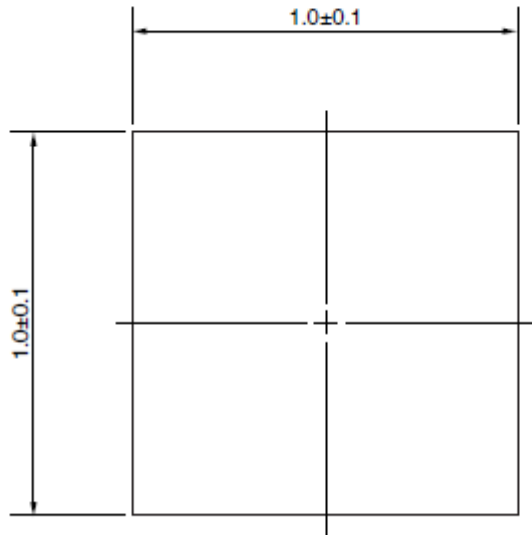

(Bottom View)

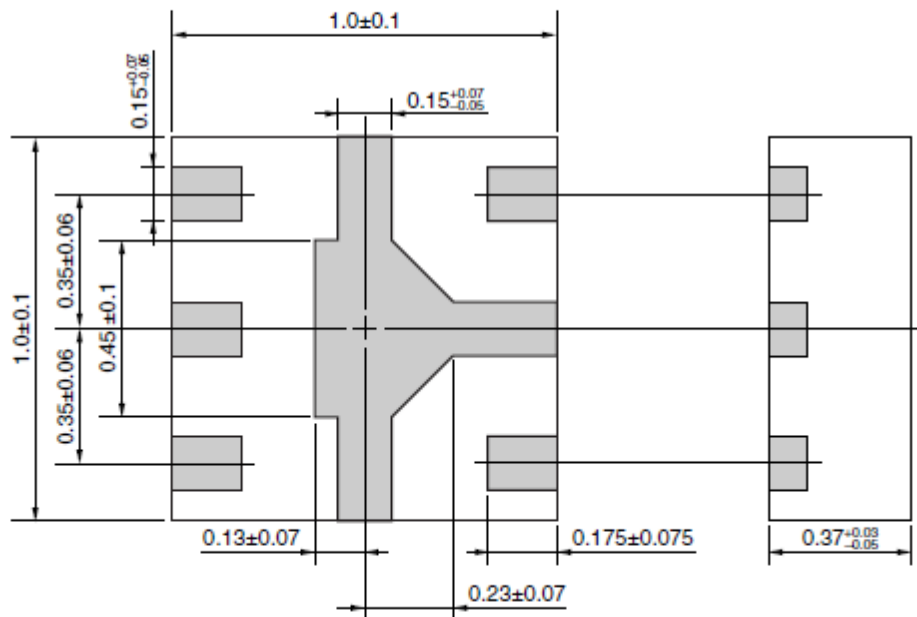

RECOMMENDED SOLDERING CONDITIONS

This product should be soldered and mounted under the following recommended conditions. For soldering methods and conditions other than those recommended below, contact your nearby sales office.

Soldering Method	Soldering Conditions	Condition Symbol
Infrared Reflow	Peak temperature (package surface temperature) : 260°C or below Time at peak temperature : 10 seconds or less Time at temperature of 220°C or higher : 60 seconds or less Preheating time at 120 to 180°C : 120±30 seconds Maximum number of reflow processes : 3 times Maximum chlorine content of rosin flux (% mass) : 0.2 % (Wt.) or below	IR260
Wave soldering	Peak temperature (molten solder temperature) : 260°C or below Time at peak temperature : 10 seconds or less Preheating temperature (package surface temperature) : 120°C or below Maximum number of reflow processes : 1 time Maximum chlorine content of rosin flux (% mass) : 0.2 % (Wt.) or below	WS260
Partial Heating	Peak temperature (pin temperature) : 350°C or below Soldering time (per side of device) : 3 seconds or less Maximum chlorine content of rosin flux (% mass) : 0.2 % (Wt.) or below	HS350

Caution Do not use different soldering methods together (except for partial heating) .

- **The information in this document is current as of xxxxx, 20xx. The information is subject to change without notice. For actual design-in, refer to the latest publications of NEC Electronics data sheets or data books, etc., for the most up-to-date specifications of NEC Electronics products. Not all products and/or types are available in every country. Please check with an NEC Electronics sales representative for availability and additional information.**
- No part of this document may be copied or reproduced in any form or by any means without the prior written consent of NEC Electronics. NEC Electronics assumes no responsibility for any errors that may appear in this document.
- NEC Electronics does not assume any liability for infringement of patents, copyrights or other intellectual property rights of third parties by or arising from the use of NEC Electronics products listed in this document or any other liability arising from the use of such products. No license, express, implied or otherwise, is granted under any patents, copyrights or other intellectual property rights of NEC Electronics or others.
- Descriptions of circuits, software and other related information in this document are provided for illustrative purposes in semiconductor product operation and application examples. The incorporation of these circuits, software and information in the design of a customer's equipment shall be done under the full responsibility of the customer. NEC Electronics assumes no responsibility for any losses incurred by customers or third parties arising from the use of these circuits, software and information.
- While NEC Electronics endeavors to enhance the quality, reliability and safety of NEC Electronics products, customers agree and acknowledge that the possibility of defects thereof cannot be eliminated entirely. To minimize risks of damage to property or injury (including death) to persons arising from defects in NEC Electronics products, customers must incorporate sufficient safety measures in their design, such as redundancy, fire-containment and anti-failure features.
- NEC Electronics products are classified into the following three quality grades: "Standard", "Special" and "Specific".
The "Specific" quality grade applies only to NEC Electronics products developed based on a customer-designated "quality assurance program" for a specific application. The recommended applications of an NEC Electronics product depend on its quality grade, as indicated below. Customers must check the quality grade of each NEC Electronics product before using it in a particular application.
 - "Standard": Computers, office equipment, communications equipment, test and measurement equipment, audio and visual equipment, home electronic appliances, machine tools, personal electronic equipment and industrial robots.
 - "Special": Transportation equipment (automobiles, trains, ships, etc.), traffic control systems, anti-disaster systems, anti-crime systems, safety equipment and medical equipment (not specifically designed for life support).
 - "Specific": Aircraft, aerospace equipment, submersible repeaters, nuclear reactor control systems, life support systems and medical equipment for life support, etc.

The quality grade of NEC Electronics products is "Standard" unless otherwise expressly specified in NEC Electronics data sheets or data books, etc. If customers wish to use NEC Electronics products in applications not intended by NEC Electronics, they must contact an NEC Electronics sales representative in advance to determine NEC Electronics' willingness to support a given application.

(Note)

- (1) "NEC Electronics" as used in this statement means NEC Electronics Corporation and also includes its majority-owned subsidiaries.
- (2) "NEC Electronics products" means any product developed or manufactured by or for NEC Electronics (as defined above).

M&E 02.11-1

SAFETY INFORMATION ON THIS PRODUCT

<p>Caution GaAs products</p>	<p>The product contains gallium arsenide, GaAs. GaAs vapor and powder are hazardous to human health if inhaled or ingested.</p> <ul style="list-style-type: none"> · Do not destroy or burn the product. · Do not cut or cleave off any part of the product. · Do not crush or chemically dissolve the product. · Do not put the product in the mouth. <p>Follow related laws and ordinances for disposal. The product should be from general industrial waste or household garbage.</p>
-------------------------------------	---

Subject: Compliance with EU Directives

CEL certifies, to its knowledge, that semiconductor and laser products detailed below are compliant with the requirements of European Union (EU) Directive 2002/95/EC Restriction on Use of Hazardous Substances in electrical and electronic equipment (RoHS) and the requirements of EU Directive 2003/11/EC Restriction on Penta and Octa BDE.

CEL Pb-free products have the same base part number with a suffix added. The suffix –A indicates that the device is Pb-free. The –AZ suffix is used to designate devices containing Pb which are exempted from the requirement of RoHS directive (*). In all cases the devices have Pb-free terminals. All devices with these suffixes meet the requirements of the RoHS directive.

This status is based on CEL’s understanding of the EU Directives and knowledge of the materials that go into its products as of the date of disclosure of this information.

Restricted Substance per RoHS	Concentration Limit per RoHS (values are not yet fixed)	Concentration contained in CEL devices	
		-A	-AZ
Lead (Pb)	< 1000 PPM	Not Detected	(*)
Mercury	< 1000 PPM	Not Detected	
Cadmium	< 100 PPM	Not Detected	
Hexavalent Chromium	< 1000 PPM	Not Detected	
PBB	< 1000 PPM	Not Detected	
PBDE	< 1000 PPM	Not Detected	

If you should have any additional questions regarding our devices and compliance to environmental standards, please do not hesitate to contact your local representative.

Important Information and Disclaimer: Information provided by CEL on its website or in other communications concerning the substance content of its products represents knowledge and belief as of the date that it is provided. CEL bases its knowledge and belief on information provided by third parties and makes no representation or warranty as to the accuracy of such information. Efforts are underway to better integrate information from third parties. CEL has taken and continues to take reasonable steps to provide representative and accurate information but may not have conducted destructive testing or chemical analysis on incoming materials and chemicals. CEL and CEL suppliers consider certain information to be proprietary, and thus CAS numbers and other limited information may not be available for release.

In no event shall CEL’s liability arising out of such information exceed the total purchase price of the CEL part(s) at issue sold by CEL to customer on an annual basis.

See CEL Terms and Conditions for additional clarification of warranties and liability.