

**Typical Applications**

- Anti-lock Braking Systems (ABS)
- Electronic Fuel Injection
- Power Doors, Windows & Seats

**Benefits**

- Advanced Process Technology
- Dual N-Channel MOSFET
- Ultra Low On-Resistance
- 175°C Operating Temperature
- Repetitive Avalanche Allowed up to Tjmax
- Automotive [Q101] Qualified

**Description**

Specifically designed for Automotive applications, these HEXFET® Power MOSFET's in a Dual SO-8 package utilize the latest processing techniques to achieve extremely low on-resistance per silicon area. Additional features of these Automotive qualified HEXFET Power MOSFET's are a 175°C junction operating temperature, fast switching speed and improved repetitive avalanche rating. These benefits combine to make this design an extremely efficient and reliable device for use in Automotive applications and a wide variety of other applications.

The efficient SO-8 package provides enhanced thermal characteristics and dual MOSFET die capability making it ideal in a variety of power applications. This dual, surface mount SO-8 can dramatically reduce board space and is also available in Tape & Reel.

HEXFET® Power MOSFET

V <sub>DSS</sub>	R <sub>DS(on)</sub> max (mΩ)	I <sub>D</sub>
50V	130@V <sub>GS</sub> = 10V	3.0A
	200@V <sub>GS</sub> = 4.5V	1.5A

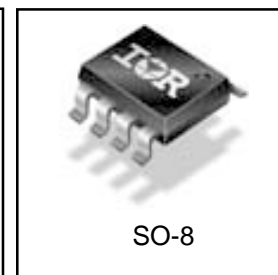
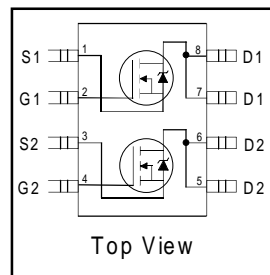

**Absolute Maximum Ratings**

	Parameter	Max.	Units
I <sub>D</sub> @ T <sub>C</sub> = 25°C	Continuous Drain Current, V <sub>GS</sub> @ 4.5V	3.0	A
I <sub>D</sub> @ T <sub>C</sub> = 70°C	Continuous Drain Current, V <sub>GS</sub> @ 4.5V	2.5	
I <sub>DM</sub>	Pulsed Drain Current ①	25	
P <sub>D</sub> @ T <sub>C</sub> = 25°C	Power Dissipation ③	2.4	W
	Linear Derating Factor	16	mW/°C
V <sub>GS</sub>	Gate-to-Source Voltage	± 20	V
E <sub>AS</sub>	Single Pulse Avalanche Energy ④	22	mJ
I <sub>AR</sub>	Avalanche Current ①	See Fig.16c, 16d, 19, 20	A
E <sub>AR</sub>	Repetitive Avalanche Energy ⑥		mJ
dv/dt	Peak Diode Recovery dv/dt ⑤	12	V/ns
T <sub>J</sub> , T <sub>STG</sub>	Junction and Storage Temperature Range	-55 to + 175	°C

**Thermal Resistance**

Symbol	Parameter	Typ.	Max.	Units
R <sub>θJL</sub>	Junction-to-Drain Lead	—	20	°C/W
R <sub>θJA</sub>	Junction-to-Ambient ③	—	50	

## Electrical Characteristics @ $T_J = 25^\circ\text{C}$ (unless otherwise specified)

	Parameter	Min.	Typ.	Max.	Units	Conditions
$V_{(BR)DSS}$	Drain-to-Source Breakdown Voltage	50	—	—	V	$V_{GS} = 0V, I_D = 250\mu A$
$\Delta V_{(BR)DSS}/\Delta T_J$	Breakdown Voltage Temp. Coefficient	—	0.057	—	V/°C	Reference to $25^\circ\text{C}, I_D = 1mA$
$R_{DS(on)}$	Static Drain-to-Source On-Resistance	—	—	130	mΩ	$V_{GS} = 10V, I_D = 3.0A$ ②
		—	—	200		$V_{GS} = 4.5V, I_D = 1.5A$ ②
$V_{GS(th)}$	Gate Threshold Voltage	1.0	—	3.0	V	$V_{DS} = V_{GS}, I_D = 250\mu A$
$g_{fs}$	Forward Transconductance	3.4	—	—	S	$V_{DS} = 15V, I_D = 3.0A$
$I_{DSS}$	Drain-to-Source Leakage Current	—	—	2.0	μA	$V_{DS} = 40V, V_{GS} = 0V$
		—	—	25		$V_{DS} = 40V, V_{GS} = 0V, T_J = 55^\circ\text{C}$
$I_{GSS}$	Gate-to-Source Forward Leakage	—	—	100	nA	$V_{GS} = 20V$
	Gate-to-Source Reverse Leakage	—	—	-100		$V_{GS} = -20V$
$Q_g$	Total Gate Charge	—	10	15	nC	$I_D = 2.0A$
$Q_{gs}$	Gate-to-Source Charge	—	1.2	—		$V_{DS} = 40V$
$Q_{gd}$	Gate-to-Drain ("Miller") Charge	—	2.8	—		$V_{GS} = 10V$
$t_{d(on)}$	Turn-On Delay Time	—	5.1	—	ns	$V_{DD} = 25V$ ②
$t_r$	Rise Time	—	1.7	—		$I_D = 1.0A$
$t_{d(off)}$	Turn-Off Delay Time	—	15	—		$R_G = 6.0\Omega$
$t_f$	Fall Time	—	2.3	—		$R_D = 25\Omega$
$C_{iss}$	Input Capacitance	—	255	—	pF	$V_{GS} = 0V$
$C_{oss}$	Output Capacitance	—	69	—		$V_{DS} = 25V$
$C_{rss}$	Reverse Transfer Capacitance	—	29	—		$f = 1.0MHz$

## Source-Drain Ratings and Characteristics

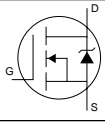
	Parameter	Min.	Typ.	Max.	Units	Conditions
$I_S$	Continuous Source Current (Body Diode)	—	—	3.0	A	MOSFET symbol showing the integral reverse p-n junction diode. 
$I_{SM}$	Pulsed Source Current (Body Diode) ①	—	—	12		
$V_{SD}$	Diode Forward Voltage	—	—	1.2	V	$T_J = 25^\circ\text{C}, I_S = 1.5A, V_{GS} = 0V$ ②
$t_{rr}$	Reverse Recovery Time	—	35	53	ns	$T_J = 25^\circ\text{C}, I_F = 1.5A$
$Q_{rr}$	Reverse Recovery Charge	—	45	67	nC	$di/dt = 100A/\mu s$ ②

### Notes:

- ① Repetitive rating; pulse width limited by max. junction temperature.
- ② Pulse width  $\leq 400\mu s$ ; duty cycle  $\leq 2\%$ .
- ③ Surface mounted on 1 in square Cu board
- ④ Starting  $T_J = 25^\circ\text{C}$ ,  $L = 4.9mH$   
 $R_G = 25\Omega, I_{AS} = 3.0A$ . (See Figure 12).
- ⑤  $I_{SD} \leq 2.0A, di/dt \leq 155A/\mu s, V_{DD} \leq V_{(BR)DSS}, T_J \leq 175^\circ\text{C}$
- ⑥ Limited by  $T_{Jmax}$ , see Fig.16c, 16d, 19, 20 for typical repetitive avalanche performance.

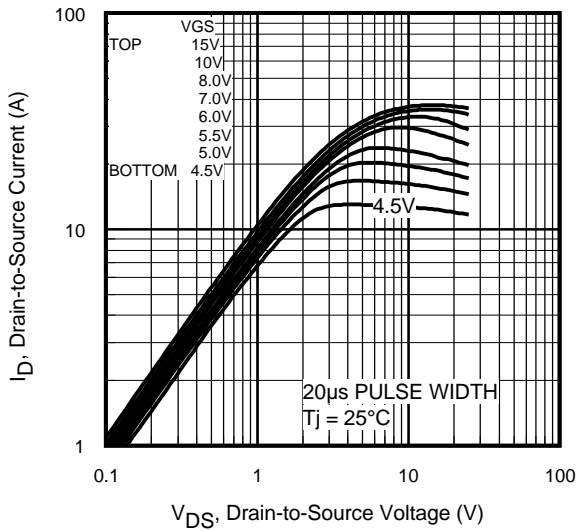

**Fig 1.** Typical Output Characteristics

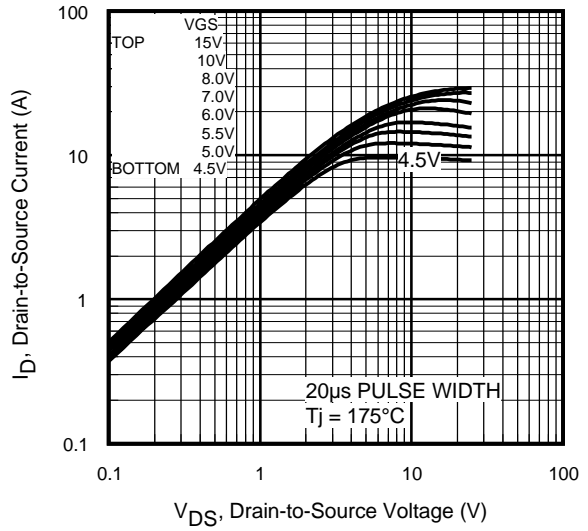

**Fig 2.** Typical Output Characteristics

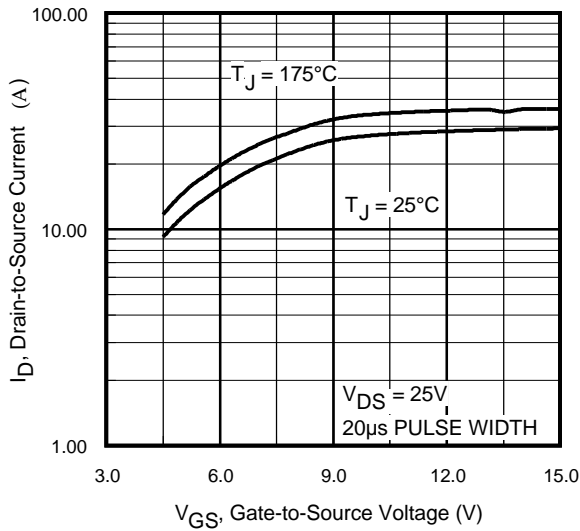

**Fig 3.** Typical Transfer Characteristics

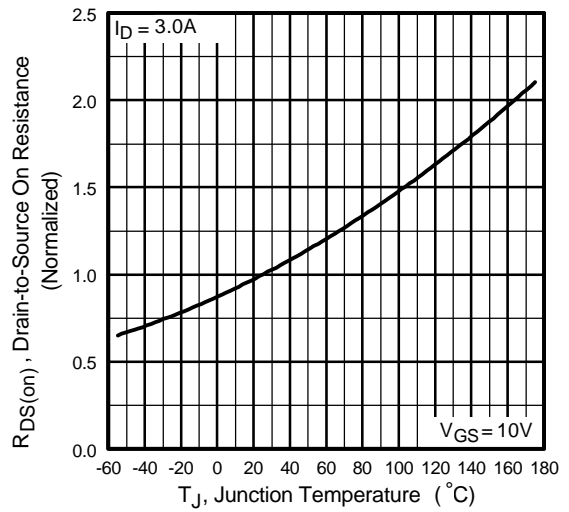

**Fig 4.** Normalized On-Resistance Vs. Temperature

# IRF7103Q

International  
**IR** Rectifier

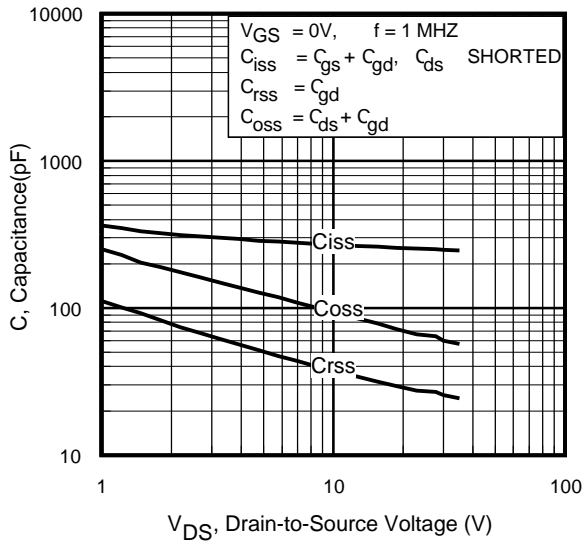

**Fig 5.** Typical Capacitance Vs. Drain-to-Source Voltage

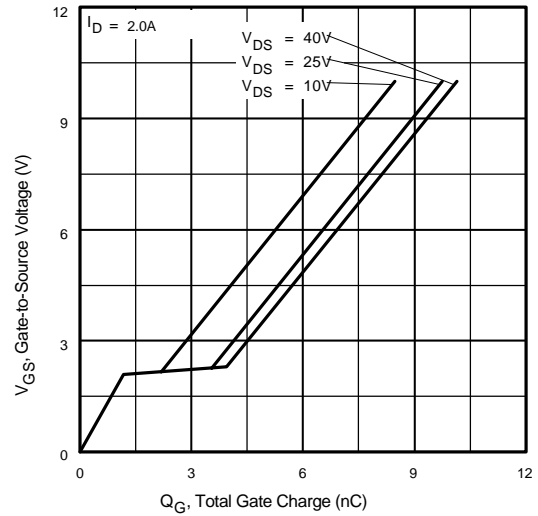

**Fig 6.** Typical Gate Charge Vs. Gate-to-Source Voltage

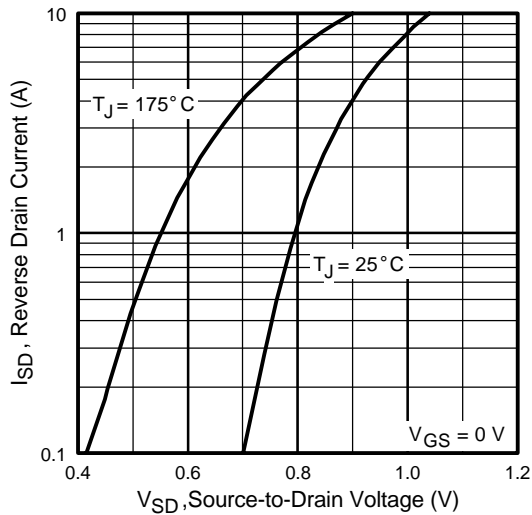

**Fig 7.** Typical Source-Drain Diode Forward Voltage

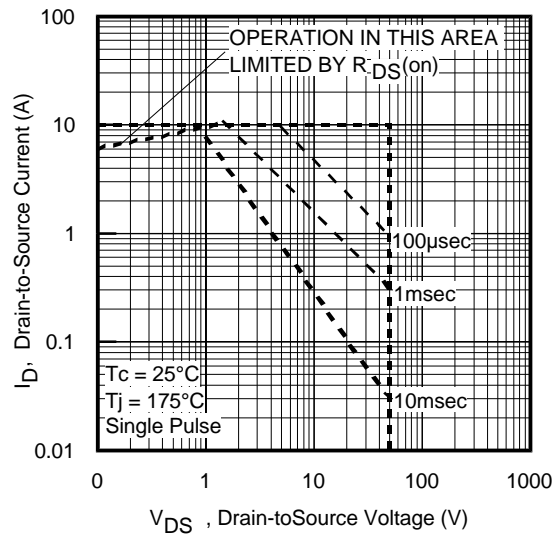

**Fig 8.** Maximum Safe Operating Area

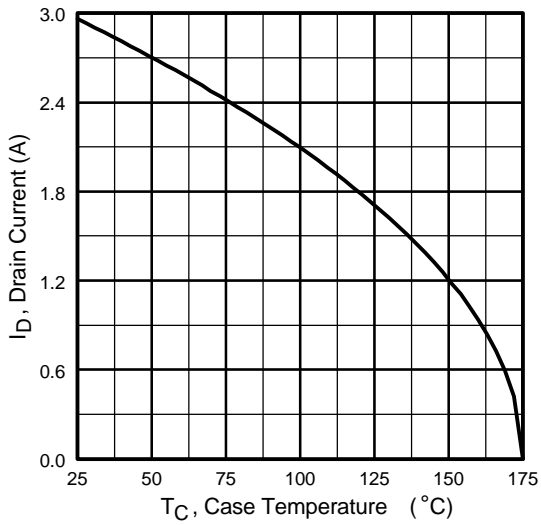

**Fig 9.** Maximum Drain Current Vs. Case Temperature

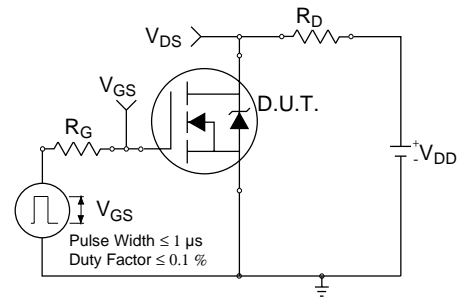

**Fig 10a.** Switching Time Test Circuit

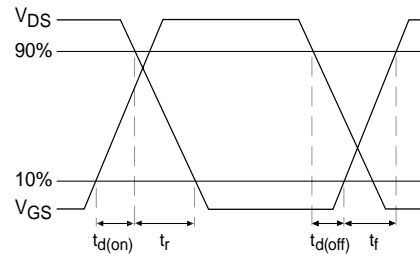

**Fig 10b.** Switching Time Waveforms

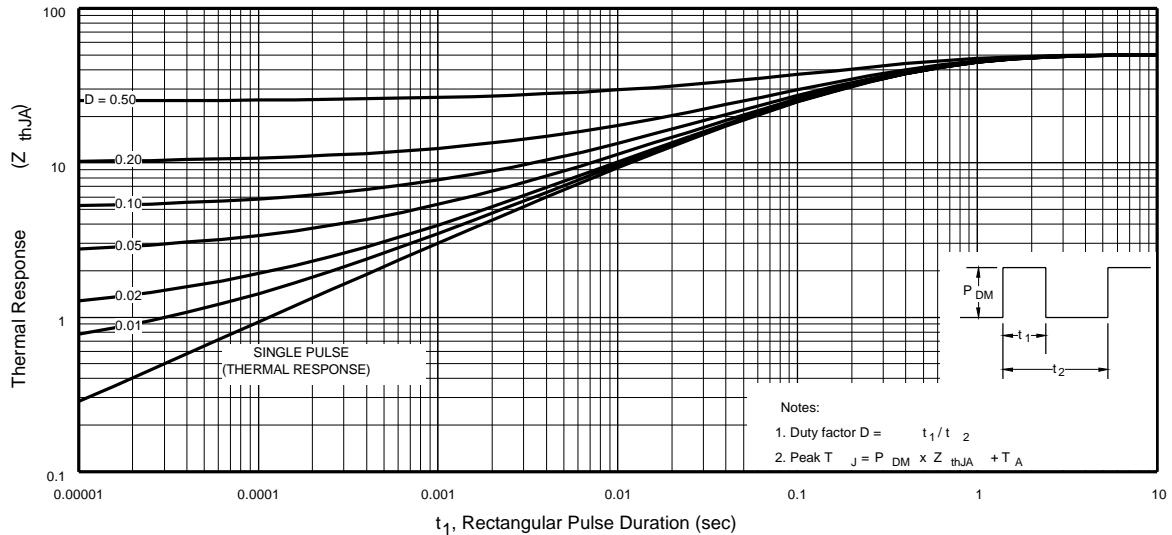

**Fig 11.** Typical Effective Transient Thermal Impedance, Junction-to-Ambient

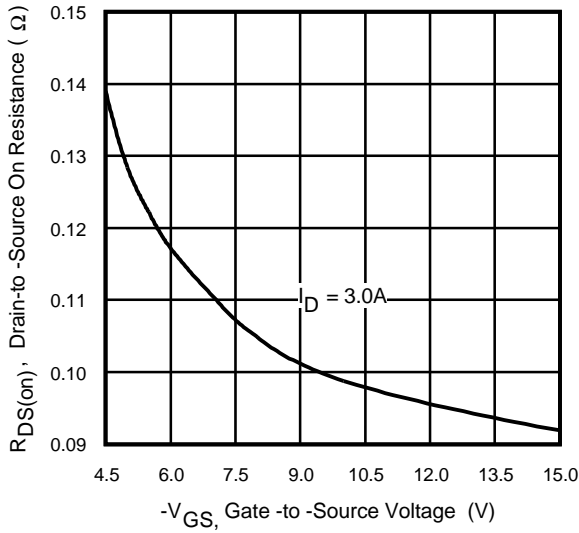

**Fig 12.** Typical On-Resistance Vs. Gate Voltage

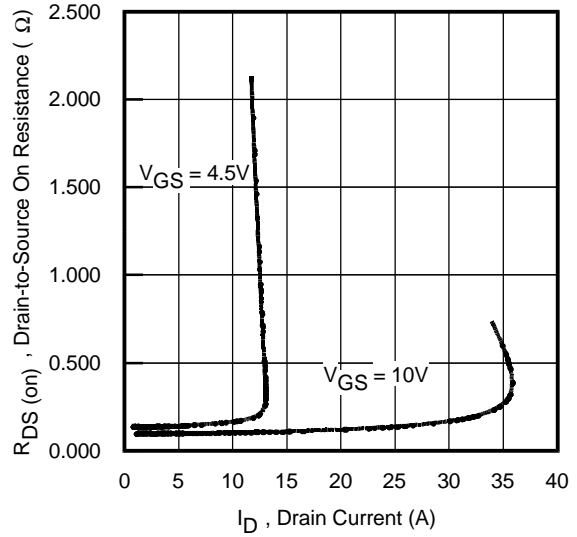

**Fig 13.** Typical On-Resistance Vs. Drain Current

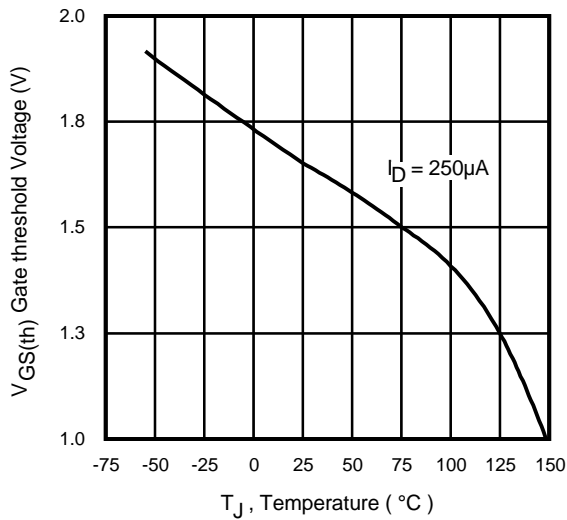

**Fig 14.** Typical Threshold Voltage Vs. Junction Temperature

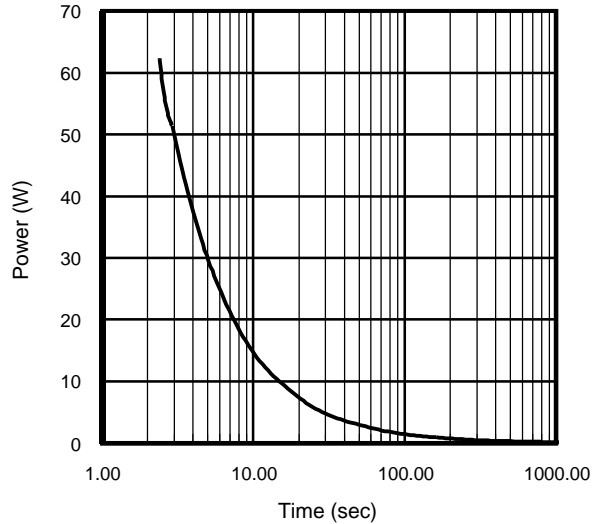

**Fig 15.** Typical Power Vs. Time

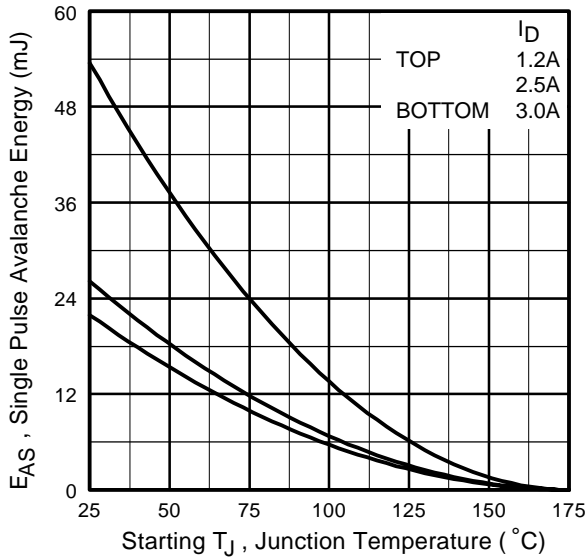

**Fig 16a.** Maximum Avalanche Energy Vs. Drain Current

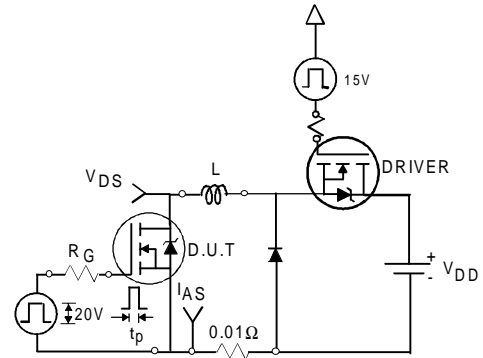

**Fig 16c.** Unclamped Inductive Test Circuit

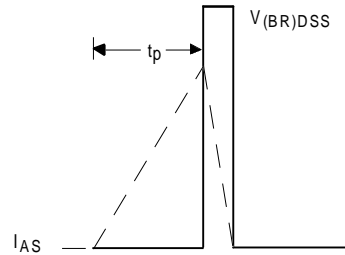

**Fig 16d.** Unclamped Inductive Waveforms

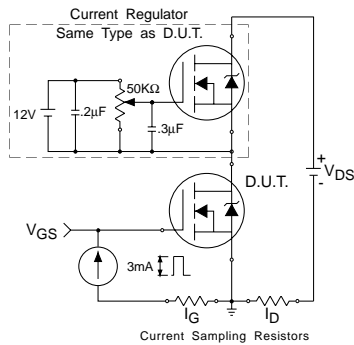

**Fig 17.** Gate Charge Test Circuit

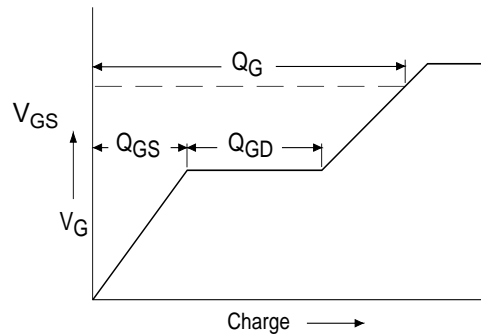

**Fig 18.** Basic Gate Charge Waveform

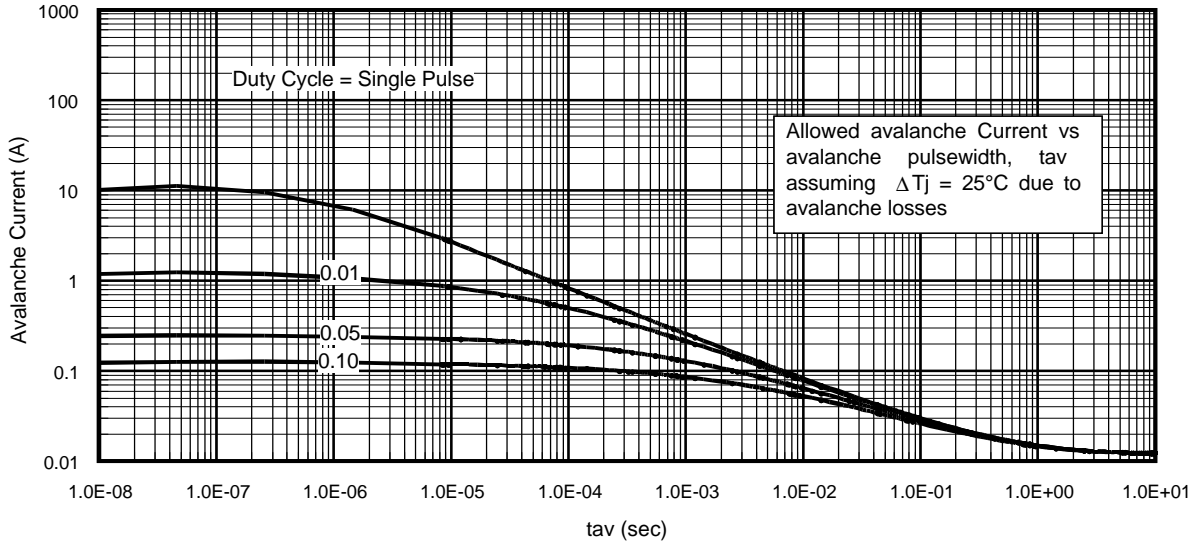

**Fig 19.** Typical Avalanche Current Vs.Pulsewidth

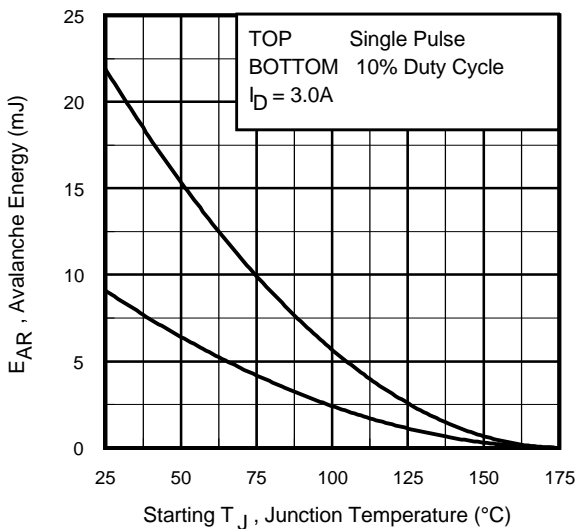

**Fig 20.** Maximum Avalanche Energy Vs. Temperature

**Notes on Repetitive Avalanche Curves , Figures 15, 16:**  
**(For further info, see AN-1005 at www.irf.com)**

1. Avalanche failures assumption:  
Purely a thermal phenomenon and failure occurs at a temperature far in excess of  $T_{jmax}$ . This is validated for every part type.
2. Safe operation in Avalanche is allowed as long as  $T_{jmax}$  is not exceeded.
3. Equation below based on circuit and waveforms shown in Figures 12a, 12b.
4.  $P_{D(ave)}$  = Average power dissipation per single avalanche pulse.
5.  $BV$  = Rated breakdown voltage (1.3 factor accounts for voltage increase during avalanche).
6.  $I_{av}$  = Allowable avalanche current.
7.  $\Delta T$  = Allowable rise in junction temperature, not to exceed  $T_{jmax}$  (assumed as 25°C in Figure 15, 16).  
 $t_{av}$  = Average time in avalanche.  
 $D$  = Duty cycle in avalanche =  $t_{av} \cdot f$   
 $Z_{thJC}(D, t_{av})$  = Transient thermal resistance, see figure 11)

$$P_{D(ave)} = 1/2 ( 1.3 \cdot BV \cdot I_{av} ) = \Delta T / Z_{thJC}$$

$$I_{av} = 2\Delta T / [1.3 \cdot BV \cdot Z_{th}]$$

$$E_{AS(AR)} = P_{D(ave)} \cdot t_{av}$$



## SO-8 Package Details

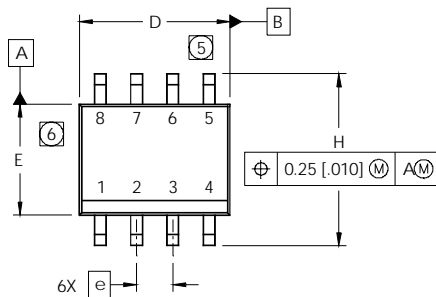

DIM	INCHES		MILLIMETERS	
	MIN	MAX	MIN	MAX
A	.0532	.0688	1.35	1.75
A1	.0040	.0098	0.10	0.25
b	.013	.020	0.33	0.51
c	.0075	.0098	0.19	0.25
D	.189	.1968	4.80	5.00
E	.1497	.1574	3.80	4.00
e	.050 BASIC		1.27 BASIC	
e1	.025 BASIC		0.635 BASIC	
H	.2284	.2440	5.80	6.20
K	.0099	.0196	0.25	0.50
L	.016	.050	0.40	1.27
y	0°	8°	0°	8°

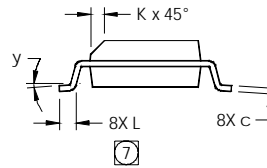
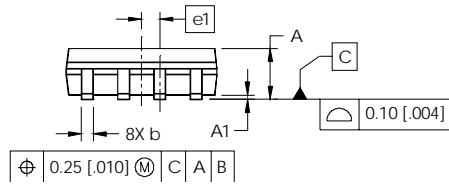

**NOTES:**

- DIMENSIONING & TOLERANCING PER ASME Y14.5M-1994.
- CONTROLLING DIMENSION: MILLIMETER
- DIMENSIONS ARE SHOWN IN MILLIMETERS [INCHES].
- OUTLINE CONFORMS TO JEDEC OUTLINE MS-012AA
- DIMENSION DOES NOT INCLUDE MOLD PROTRUSIONS. MOLD PROTRUSIONS NOT TO EXCEED 0.15 [0.006].
- DIMENSION DOES NOT INCLUDE MOLD PROTRUSIONS. MOLD PROTRUSIONS NOT TO EXCEED 0.25 [0.010].
- DIMENSION IS THE LENGTH OF LEAD FOR SOLDERING TO A SUBSTRATE.

**FOOTPRINT**

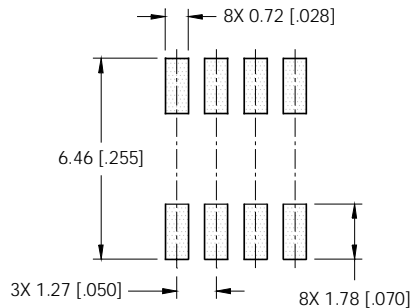

## SO-8 Part Marking

EXAMPLE: THIS IS AN IRF7101 (MOSFET)

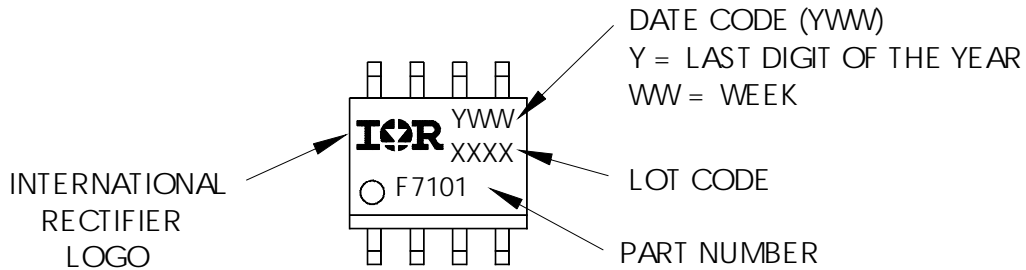

# IRF7103Q

International  
**IR** Rectifier

## SO-8 Tape and Reel

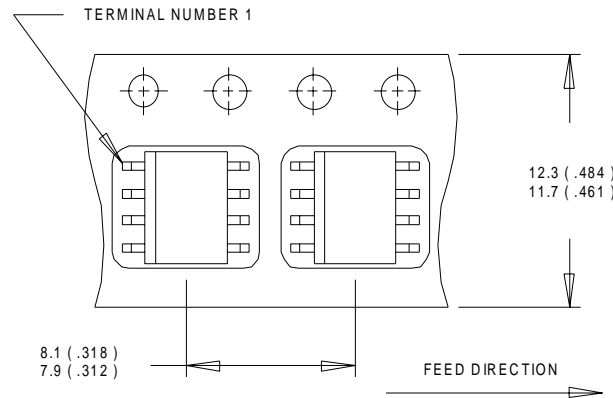

- NOTES:
1. CONTROLLING DIMENSION : MILLIMETER.
  2. ALL DIMENSIONS ARE SHOWN IN MILLIMETERS(INCHES).
  3. OUTLINE CONFORMS TO EIA-481 & EIA-541.

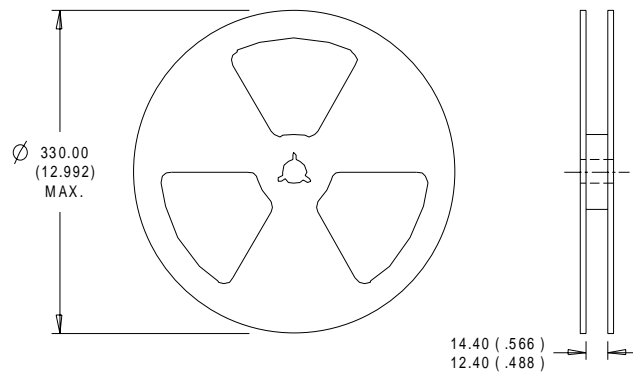

- NOTES :
1. CONTROLLING DIMENSION : MILLIMETER.
  2. OUTLINE CONFORMS TO EIA-481 & EIA-541.

Data and specifications subject to change without notice.  
This product has been designed and qualified for the Automotive [Q101] market.  
Qualification Standards can be found on IR's Web site.

International  
**IR** Rectifier

IR WORLD HEADQUARTERS: 233 Kansas St., El Segundo, California 90245, USA Tel: (310) 252-7105  
TAC Fax: (310) 252-7903

Visit us at [www.irf.com](http://www.irf.com) for sales contact information.03/02

[www.irf.com](http://www.irf.com)