

### Isolated Triac 16 Amperes/400-600 Volts

#### OUTLINE DRAWING

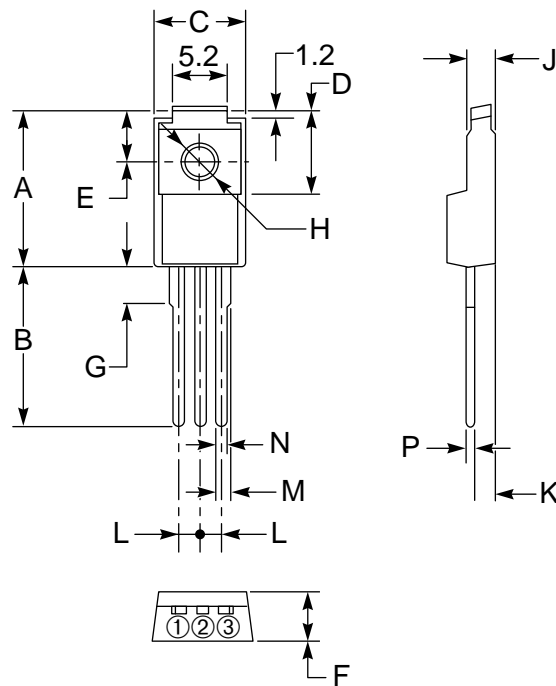

#### CONNECTION DIAGRAM

- ① T1 TERMINAL
- ② T2 TERMINAL
- ③ GATE TERMINAL

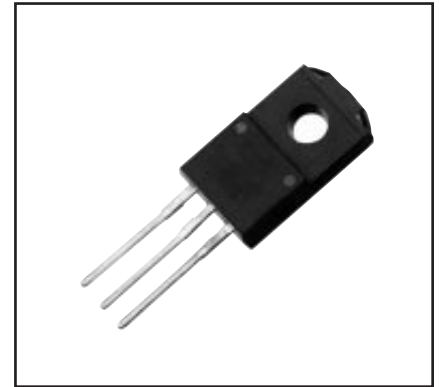
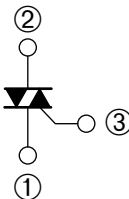

#### Description:

A triac is a solid state silicon AC switch which may be gate triggered from an off-state to an on-state for either polarity of applied voltage.

#### Features:

- Full Molded Isolation Package
- Glass Passivation
- Low Off-state Leakage
- 1500  $V_{RMS}$  Isolation Voltage
- UL Card
- Excellent Surge Capability
- Low On-state Voltage
- Selected for Inductive Loads

#### Applications:

- AC Switch
- Motor Controls
- Lighting
- TV
- SSR

#### Ordering Information:

Example: Select the complete eight, nine or ten digit part number you desire from the table - i.e. BCR16PM-8 is a 400 Volt, 16 Ampere Triac.

Outline Drawing (Conforms to TO-220F)

Dimensions	Inches	Millimeters
A	0.67	17.0
B	0.49 Min.	12.5 Min.
C	0.39	10.0
D	0.33	8.5
E	0.20	5.0
F	0.18	4.5
G	0.14	3.6

Dimensions	Inches	Millimeters
H	0.126 ± 0.008	Dia.3.2 ± 0.2 Dia.
J	0.11	2.8
K	0.102	2.6
L	0.10	2.5
M	0.039	1.0
N	0.031	0.8
P	0.020	0.5

Type	$V_{DRM}$ Volts	Code	Inductive Load*
BCR16PM	400	-8	L
	600	-12	

\*For inductive load, add L.

## BCR16PM

### Isolated Triac

16 Amperes/400-600 Volts

### Absolute Maximum Ratings, $T_a = 25^\circ\text{C}$ unless otherwise specified

Ratings	Symbol	BCR16PM-8	BCR16PM-12	Units
Repetitive Peak Off-state Voltage	$V_{\text{DRM}}$	400	600	Volts
Non-repetitive Peak Off-state Voltage	$V_{\text{DSM}}$	500	720	Volts
On-state Current, $T_c = 71^\circ\text{C}$	$I_{\text{T(RMS)}}$	16	16	Amperes
Non-repetitive Peak Surge, One Cycle (60 Hz)	$I_{\text{TSM}}$	160	160	Amperes
$I^2t$ for Fusing, $t = 8.3$ msec	$I^2t$	106.5	106.5	$\text{A}^2\text{sec}$
Peak Gate Power Dissipation, 20 $\mu\text{sec}$	$P_{\text{GM}}$	5	5	Watts
Average Gate Power Dissipation	$P_{\text{G(avg)}}$	0.5	0.5	Watts
Peak Gate Current	$I_{\text{GM}}$	2	2	Amperes
Peak Gate Voltage	$V_{\text{GM}}$	10	10	Volts
Storage Temperature	$T_{\text{stg}}$	-40 to 125	-40 to 125	$^\circ\text{C}$
Operating Junction Temperature	$T_j$	-40 to 125	-40 to 125	$^\circ\text{C}$
Isolation Voltage	$V_{\text{iso}}$	1500	1500	Volts
Weight	-	2	2	Grams

### Electrical and Thermal Characteristics, $T_j = 25^\circ\text{C}$ unless otherwise specified

Characteristics	Symbol	Test Conditions (Trigger Mode)				BCR16PM			Units
		$V_D$	$R_L$	$R_G$	$T_j$	Min.	Typ.	Max.	
Gate Parameters									
DC Gate Trigger Current									
MT2+ Gate+	$I_{\text{FGT I}}$	6V	6 $\Omega$	330 $\Omega$	25 $^\circ\text{C}$	-	-	30	mA
MT2+ Gate-	$I_{\text{RGT I}}$	6V	6 $\Omega$	330 $\Omega$	25 $^\circ\text{C}$	-	-	30	mA
MT2- Gate-	$I_{\text{RGT III}}$	6V	6 $\Omega$	330 $\Omega$	25 $^\circ\text{C}$	-	-	30	mA
DC Gate Trigger Voltage									
MT2+ Gate+	$V_{\text{FGT I}}$	6V	6 $\Omega$	330 $\Omega$	25 $^\circ\text{C}$	-	-	1.5	Volts
MT2+ Gate-	$V_{\text{RGT I}}$	6V	6 $\Omega$	330 $\Omega$	25 $^\circ\text{C}$	-	-	1.5	Volts
MT2- Gate-	$V_{\text{RGT III}}$	6V	6 $\Omega$	330 $\Omega$	25 $^\circ\text{C}$	-	-	1.5	Volts
DC Gate Non-trigger Voltage									
All	$V_{\text{GD}}$	1/2 $V_{\text{DRM}}$	-	-	125 $^\circ\text{C}$	0.2	-	-	Volts

Characteristics	Symbol	Test Conditions	Min.	Typ.	Max.	Units
Thermal Resistance, Junction-to-case	$R_{\text{th(j-c)}}$	-	-	-	3	$^\circ\text{C/W}$
Voltage – Blocking State Repetitive Off-state Current	$I_{\text{DRM}}$	Gate Open Circuited, $V_D = V_{\text{DRM}}$ , $T_j = 125^\circ\text{C}$	-	-	2	mA
Current – Conducting State Peak On-state Voltage	$V_{\text{TM}}$	$T_c = 25^\circ\text{C}$ , $I_{\text{TM}} = 25\text{A}$	-	-	1.6	Volts
Critical Rate-of-rise of Commutating Off-state Voltage (Commutating $dv/dt$ ) ▲ for inductive load (L) (Switching)	$(dv/dt)_c$	-	-	-	-	$\text{V}/\mu\text{s}$



Powerex, Inc., 200 Hillis Street, Youngwood, Pennsylvania 15697-1800 (412) 925-7272

**BCR16PM**  
**Isolated Triac**  
 16 Amperes/400-600 Volts

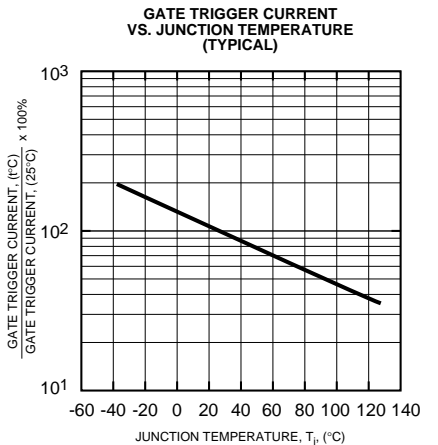
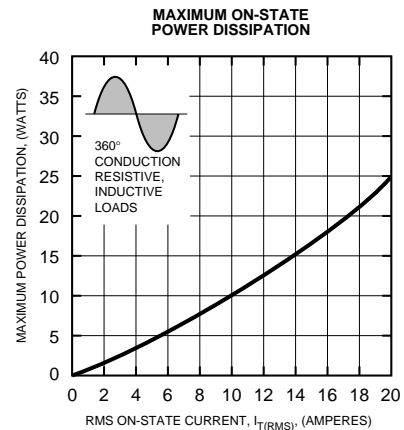
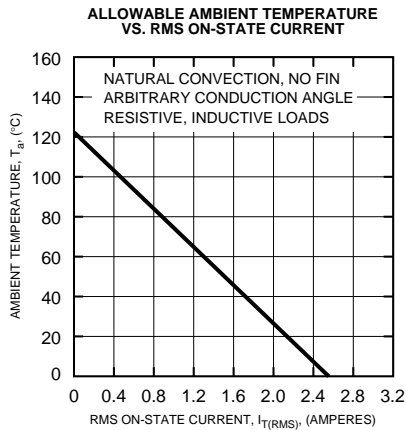
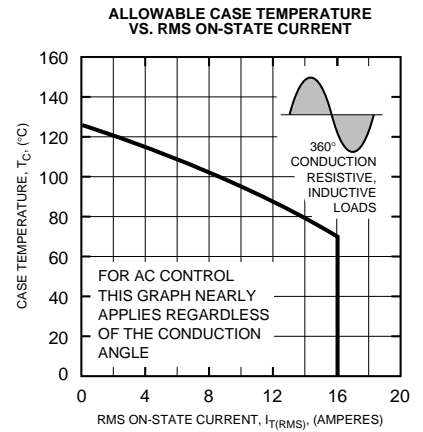
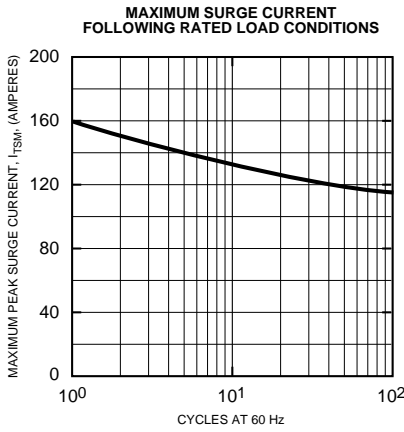
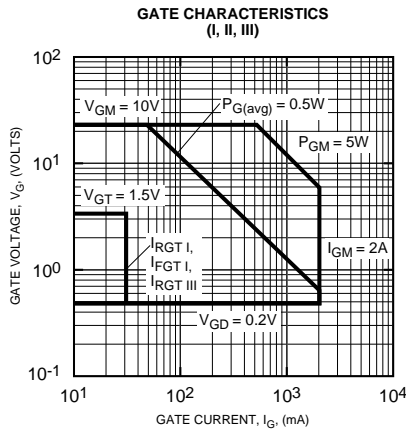
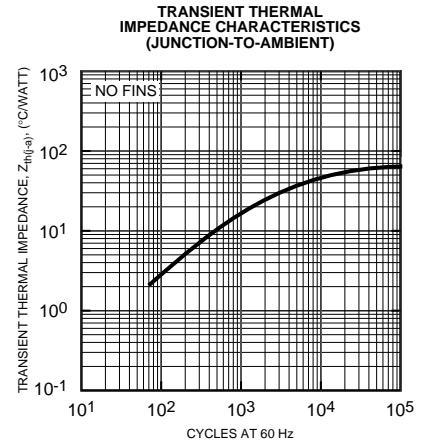
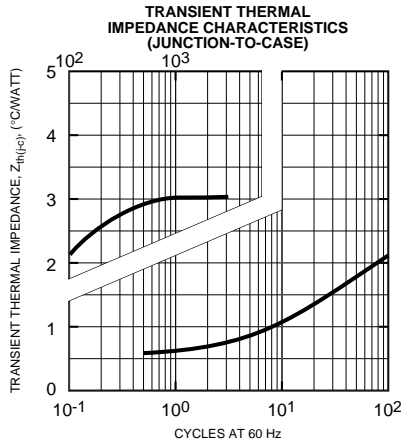
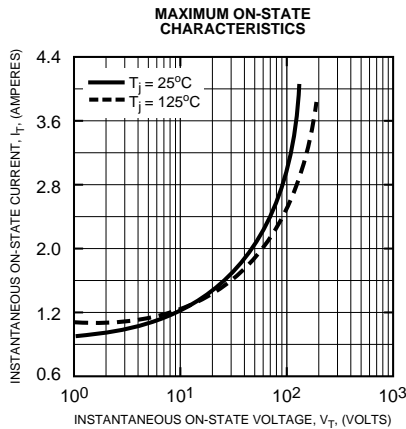

## BCR16PM

### Isolated Triac

16 Amperes/400-600 Volts

**GATE TRIGGER VOLTAGE VS. JUNCTION TEMPERATURE (TYPICAL)**

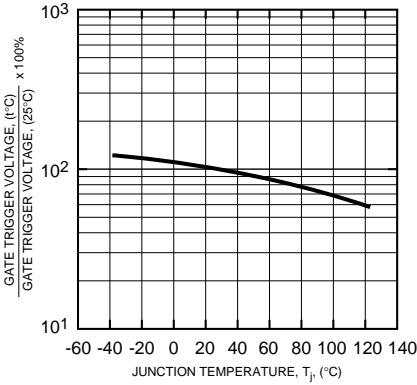

**BREAKOVER VOLTAGE VS. JUNCTION TEMPERATURE (TYPICAL)**

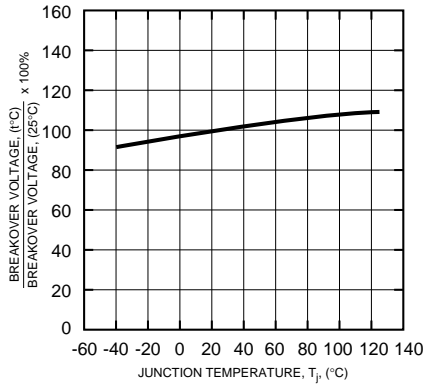

**BREAKOVER VOLTAGE VS. RATE OF RISE OF OFF-STATE VOLTAGE (TYPICAL)**

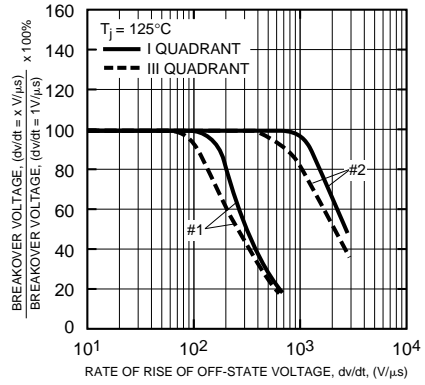

**REPETITIVE PEAK OFF-STATE CURRENT VS. JUNCTION TEMPERATURE (TYPICAL)**

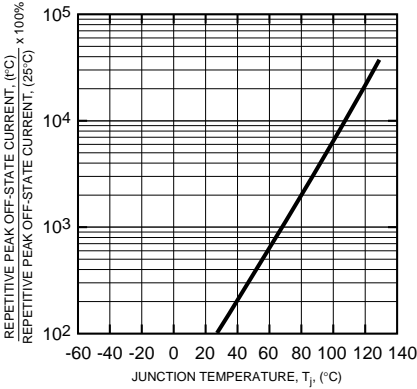

**COMMUTATION CHARACTERISTICS (TYPICAL)**

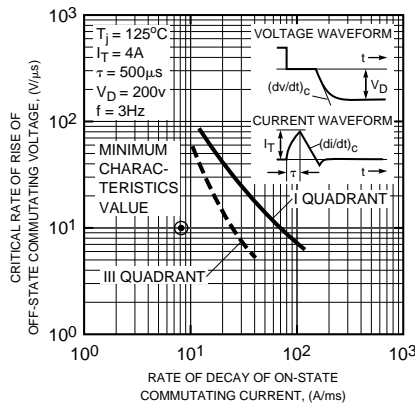

**GATE TRIGGER CURRENT VS. GATE CURRENT PULSE WIDTH (TYPICAL)**

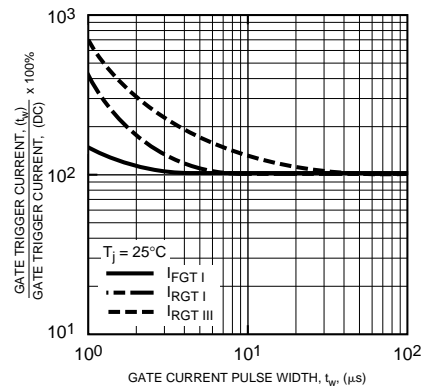

**GATE TRIGGER CHARACTERISTICS TEST CIRCUITS**

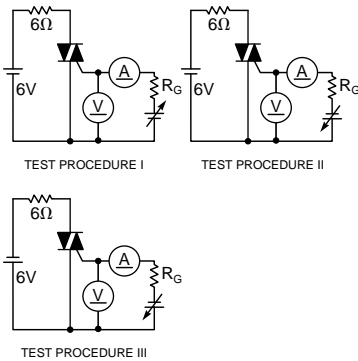

**Commutating dv/dt, (dv/dt)<sub>c</sub>**

Δ Part Number	V <sub>DRM</sub> (Volts)	Load Type	Minimum
BCR16PM-8L	400	L	10
BCR16PM-12L	600	L	10

**Commutating Voltage & Current Waveform (Inductive Load)**

