

HIGH RELIABILITY SILICON POWER RECTIFIER

Qualified per MIL-PRF-19500/246

- Glass Passivated Die
- Glass to Metal Header Construction
- VRRM to 1000V
- 1600 Amps Surge Rating

DEVICES

1N3289	1N3294	1N3289R	1N3294R
1N3291	1N3295	1N3291R	1N3295R
1N3293		1N3293R	

LEVELS

JAN
JANTX
JANTXV

ABSOLUTE MAXIMUM RATINGS (T_C = +25°C unless otherwise noted)

Parameters / Test Conditions	Symbol	Value	Unit
Peak Repetitive Reverse Voltage	V _{RWM}	1N3289 1N3289R	200
		1N3291 1N3291R	400
		1N3293 1N3293R	600
		1N3294 1N3294R	800
		1N3295 1N3295R	1000
Average Forward Current, T _C = 134°	I _F	100	A
Peak Surge Forward Current @ t _p = 8.3ms, half sinewave, T _C = 150°C	I _{FSM}	1600	A
Thermal Resistance, Junction to Case	R _{θJC}	0.4	°C/W
Operating Case Temperature Range	T _j	-65°C to 200°C	°C
Storage Temperature Range	T _{STG}	-65°C to 200°C	°C

ELECTRICAL CHARACTERISTICS (T_A = +25°C, unless otherwise noted)

Parameters / Test Conditions	Symbol	Min.	Max.	Unit	
Forward Voltage I _{FM} = 310A, T _C = 25°C *	V _{FM}		1.55	V	
Reverse Current	I _{RM}		10	mA	
V _{RM} = 200, T _C = 25°C					1N3289 1N3289R
V _{RM} = 400, T _C = 25°C					1N3291 1N3291R
V _{RM} = 600, T _C = 25°C					1N3293 1N3293R
V _{RM} = 800, T _C = 25°C					1N3294 1N3294R
V _{RM} = 1000, T _C = 25°C	1N3295 1N3295R				
Reverse Current	I _{RM}		30	mA	
V _{RM} = 200, T _C = 200°C					1N3289 1N3289R
V _{RM} = 400, T _C = 200°C					1N3291 1N3291R
V _{RM} = 600, T _C = 200°C					1N3293 1N3293R
V _{RM} = 800, T _C = 200°C					1N3294 1N3294R
V _{RM} = 1000, T _C = 200°C	1N3295 1N3295R				

* Pulse test: Pulse width 300µsec. Duty cycle 2%

Note:

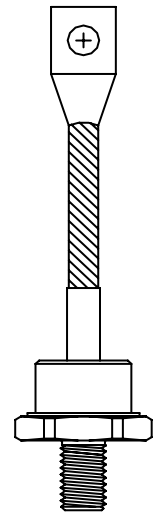

DO-205AA (DO-8)

HIGH RELIABILITY SILICON POWER RECTIFIER

GRAPHS

FIGURE 1

TYPICAL FORWARD CHARACTERISTICS

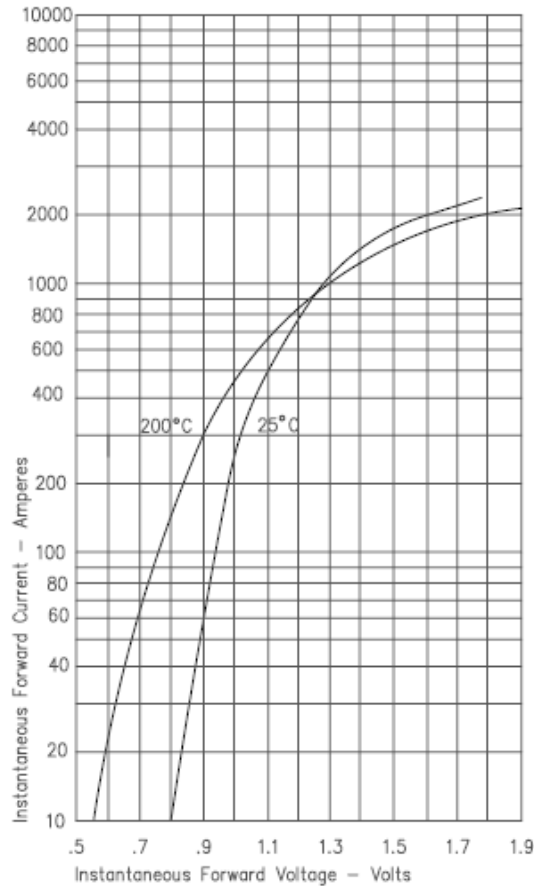

FIGURE 2

TYPICAL REVERSE CHARACTERISTICS

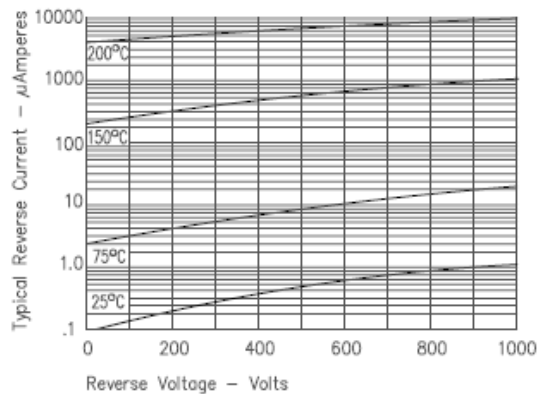

FIGURE 3

FORWARD CURRENT DERATING

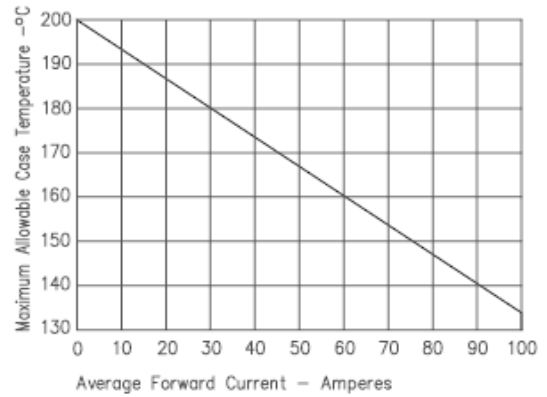

FIGURE 5

TRANSIENT THERMAL IMPEDANCE

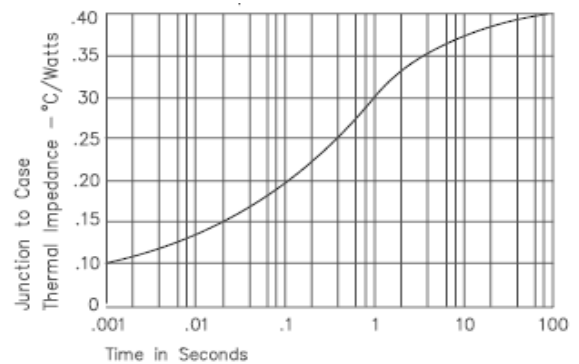
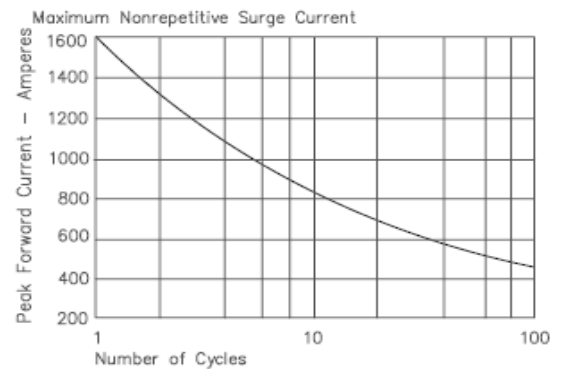

FIGURE 7

MAXIMUM NONREPETITIVE SURGE CURRENT



HIGH RELIABILITY SILICON POWER RECTIFIER

PACKAGE DIMENSIONS

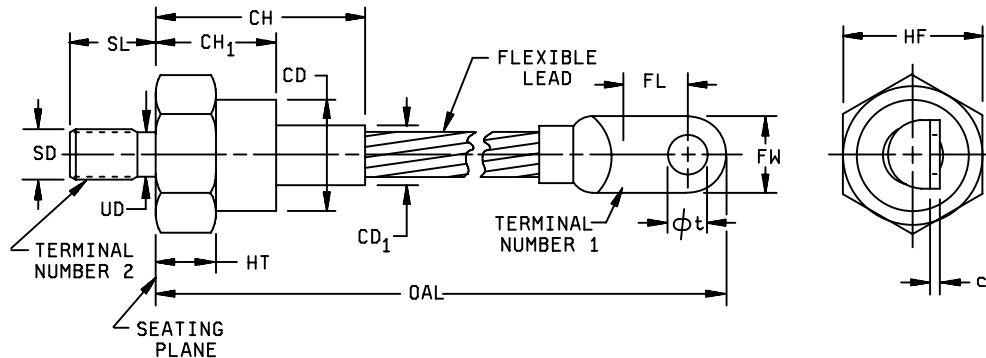

NOTES:

1. Dimensions are in inches.
2. Millimeter equivalents are given for general information only.
3. Complete threads to extend to within 2.5 threads of seating plane.
4. 375-24 UNF-2A. Maximum pitch diameter of plated threads shall be basic pitch diameter (.3479 inch (8.837 mm) reference).
5. A chamfer or undercut on one or both ends of hexagonal portions is optional.
6. Minimum flat.
7. For marking (see 3.5).
8. The body of the device, with the exception of the hexagon and flexible lead extensions, lies within cylinder defined by CD_1 and CH , CD_1 not to exceed actual HF .
9. Terminal shape is optional.
10. In accordance with ASME Y14.5M, diameters are equivalent to ϕx symbology.

Symbol	Dimensions				Notes
	Inches		Millimeters		
	Min	Max	Min	Max	
CD	.625	1.000	15.88	25.40	8
CD_1		.500		12.70	
CH		1.750		44.45	
CH_1		1.140		28.96	
c	.050	.120	1.27	3.05	
FL	.300	.450	7.62	11.43	6
FW		.670		17.02	
HF	1.031	1.063	26.19	27.00	
HT	.125	.500	3.18	12.70	5
OAL	4.300	5.065	109.22	128.65	
SD					4
SL	.605	.645	15.37	16.38	
UD	.343	.373	8.71	9.47	
ϕt	.250	.310	6.35	7.87	4

Physical dimensions