

VOLTAGE RANGE: 50 - 600

CURRENT: 1.0 A

Features

- Glass Passivated Die Construction
- Ideally Suited for Automatic Assembly
- Low Forward Voltage Drop, High Efficiency
- Low Power Loss
- Super-Fast Recovery Time
- Plastic Case Material has UL Flammability Classification Rating 94V-O

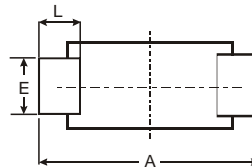
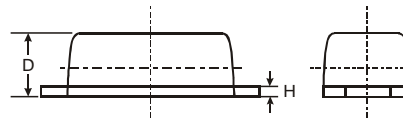
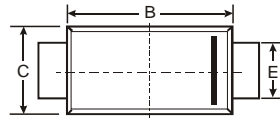
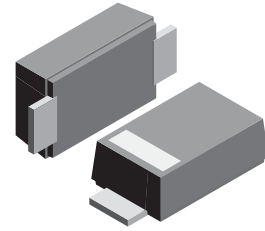

SMAF			
Dim	Min	Max	Typ
A	4.75	4.85	4.80
B	3.68	3.72	3.70
C	2.57	2.63	2.60
D	0.097	1.03	1.00
E	1.38	1.42	1.40
H	0.13	0.17	0.15
L	0.63	0.67	0.65
All Dimensions in mm			

Mechanical Data

- Case: SMAF, Molded Plastic
- Terminals: Solder Plated, Solderable per MIL-STD-750, Method 2026
- Polarity: Color band denotes cathode end
- Mounting Position: Any
- Weight: 0.0018 ounce, 0.064 grams



Maximum Ratings and Electrical Characteristics T_A = 25°C unless otherwise specified

Single phase, half wave, 60Hz, resistive or inductive load. For capacitive load, derate current by 20%.

Characteristic	Symbol	ES1AF	ES1BF	ES1CF	ES1DF	ES1EF	ES1GF	ES1JF	Unit
Peak Repetitive Reverse Voltage	V _{RRM}								V
Working Peak Reverse Voltage	V _{RWM}	50	100	150	200	300	400	600	
DC Blocking Voltage	V _R								
RMS Reverse Voltage	V _{R(RMS)}	35	70	105	140	210	280	420	V
Average Rectified Output Current @T _L = 120°C	I _o	1.0							A
Non-Repetitive Peak Forward Surge Current 8.3ms Single half sine-wave superimposed on rated load (JEDEC Method)	I _{FSM}	30							A
Forward Voltage @I _F = 1.0A	V _{FM}	0.95				1.25		1.7	V
Peak Reverse Current @T _A = 25°C At Rated DC Blocking Voltage @T _A = 100°C	I _{RM}					5.0		500	μA
Reverse Recovery Time (Note 1)	t _{rr}					35			nS
Typical Junction Capacitance (Note 2)	C _j					10			pF
Typical Thermal Resistance (Note 3)	R _{θJL}					35			°C/W
Operating and Storage Temperature Range	T _j , T _{STG}	-65 to +150							°C

Note: 1. Measured with I_F = 0.5A, I_R = 1.0A, I_{rr} = 0.25A. See figure 5.
 2. Measured at 1.0 MHz and applied reverse voltage of 4.0 V DC.
 3. Mounted on P.C. Board with 8.0mm² land area.

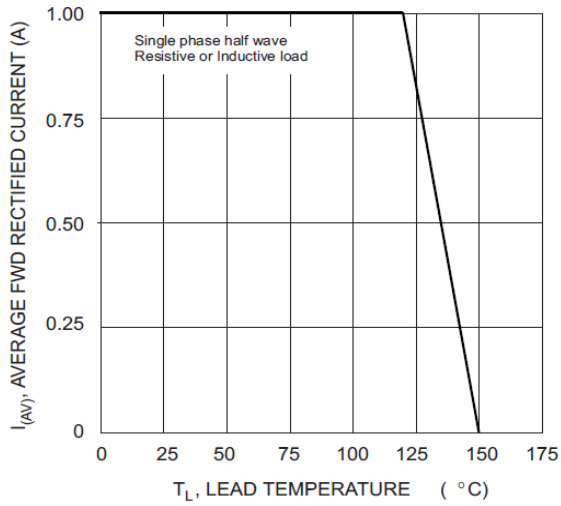

Fig. 1 Forward Current Derating Curve

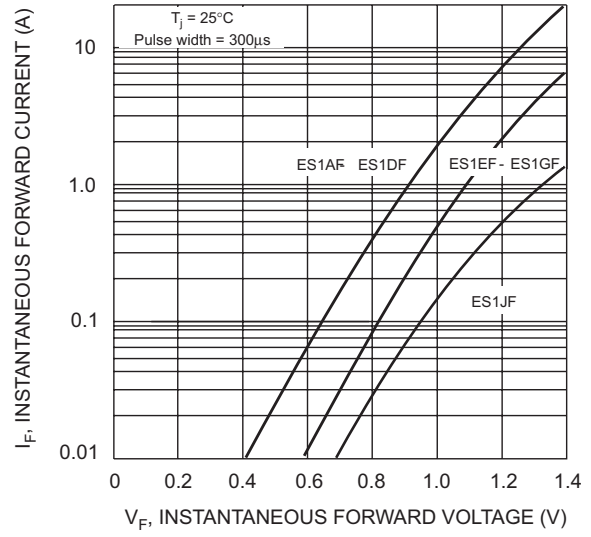

Fig. 2 Typical Forward Characteristics

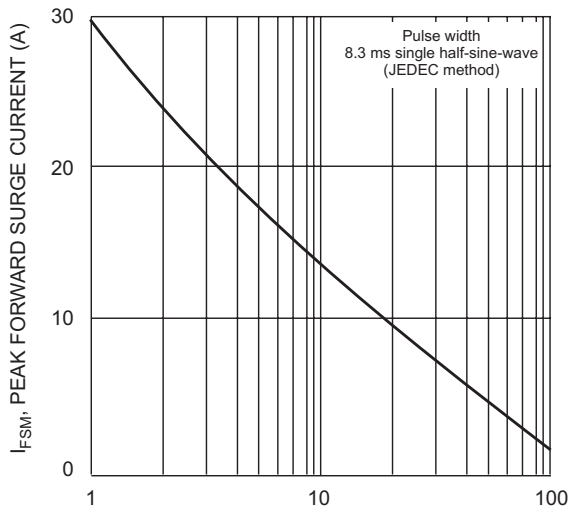

Fig. 3 Peak Forward Surge Current

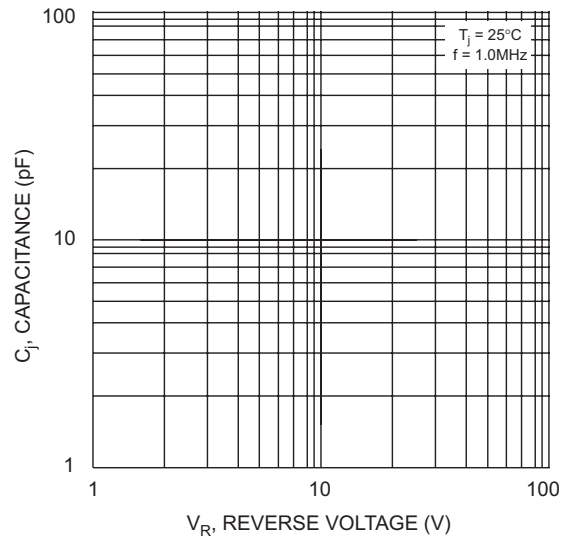
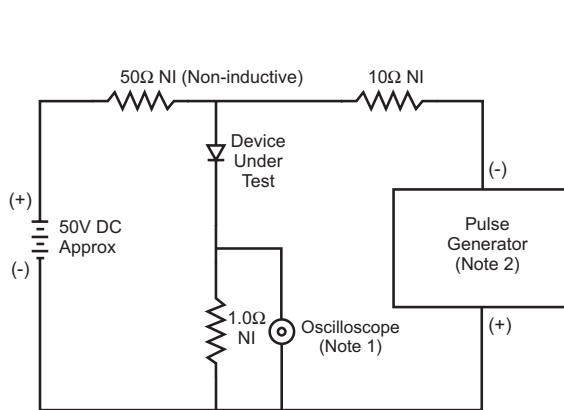
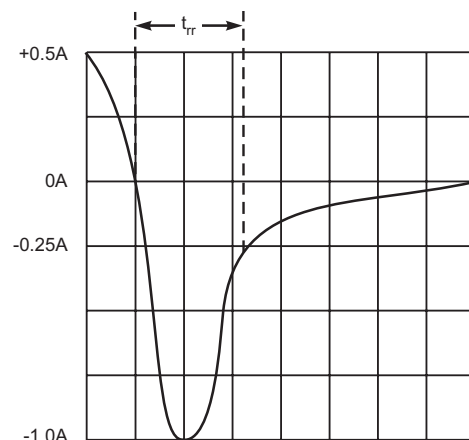

Fig. 4 Typical Junction Capacitance



- Notes:
1. Rise Time = 7.0ns max. Input Impedance = 1.0MΩ, 22pF.
 2. Rise Time = 10ns max. Input Impedance = 50Ω.



Set time base for 5/10ns/cm

Fig. 5 Reverse Recovery Time Characteristic and Test Circuit