

SN54ALS805A, SN54AS805B, SN74ALS805A, SN74AS805B HEX 2-INPUT NOR DRIVERS

SDAS023C – DECEMBER 1982 – REVISED JANUARY 1995

- High Capacitive-Drive Capability
- 'ALS805A Has Typical Delay Time of 4.2 ns ($C_L = 50$ pF) and Typical Power Dissipation of 4.2 mW Per Gate
- 'AS805B Has Typical Delay Time of 2.6 ns ($C_L = 50$ pF) and Typical Power Dissipation of 12 mW Per Gate
- Package Options Include Plastic Small-Outline (DW) Packages, Ceramic Chip Carriers (FK), and Standard Plastic (N) and Ceramic (J) 300-mil DIPs

description

These devices contain six independent 2-input NOR drivers. They perform the Boolean functions $Y = A + B$ or $Y = \bar{A} \cdot \bar{B}$ in positive logic.

The SN54ALS805A and SN54AS805B are characterized for operation over the full military temperature range of -55°C to 125°C . The SN74ALS805A and SN74AS805B are characterized for operation from 0°C to 70°C .

FUNCTION TABLE
(each driver)

INPUTS		OUTPUT
A	B	Y
H	X	L
X	H	L
L	L	H

logic symbol†

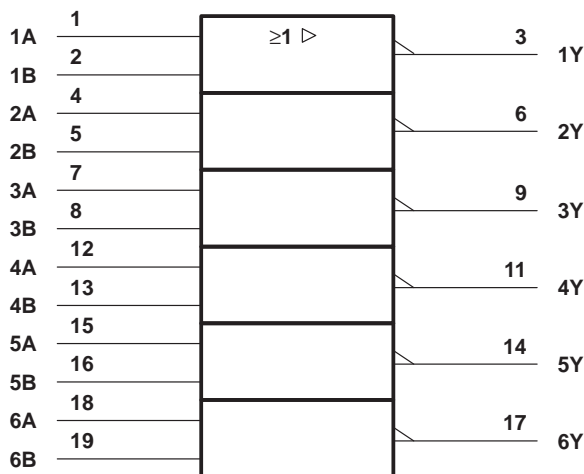

logic diagram (positive logic)

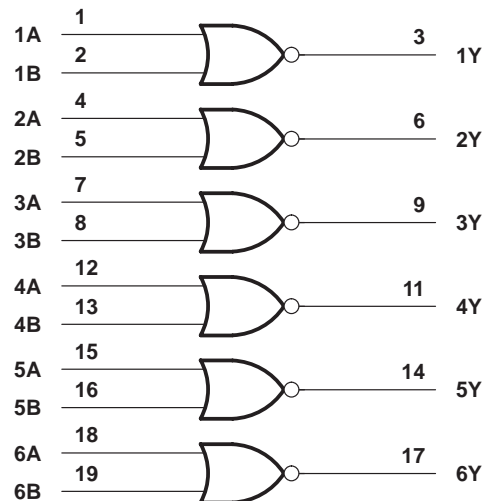

† This symbol is in accordance with ANSI/IEEE Std 91-1984 and IEC Publication 617-12.

SN54ALS805A, SN54AS805B . . . J PACKAGE
SN74ALS805A, SN74AS805B . . . DW OR N PACKAGE
(TOP VIEW)

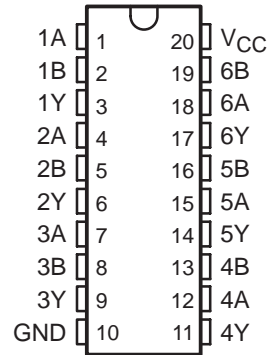

SN54ALS805A, SN54AS805B . . . FK PACKAGE
(TOP VIEW)

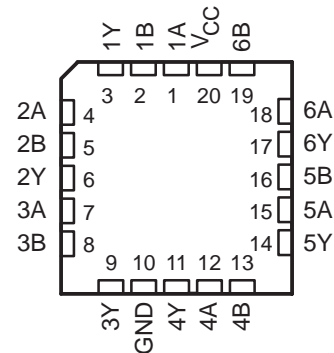

SN54ALS805A, SN54AS805B, SN74ALS805A, SN74AS805B HEX 2-INPUT NOR DRIVERS

SDAS023C – DECEMBER 1982 – REVISED JANUARY 1995

absolute maximum ratings over operating free-air temperature range (unless otherwise noted)†

Supply voltage, V_{CC}	7 V
Input voltage, V_I	7 V
Operating free-air temperature range, T_A : SN54ALS805A	-55°C to 125°C
SN74ALS805A	0°C to 70°C
Storage temperature range	-65°C to 150°C

† Stresses beyond those listed under "absolute maximum ratings" may cause permanent damage to the device. These are stress ratings only, and functional operation of the device at these or any other conditions beyond those indicated under "recommended operating conditions" is not implied. Exposure to absolute-maximum-rated conditions for extended periods may affect device reliability.

recommended operating conditions

		SN54ALS805A			SN74ALS805A			UNIT
		MIN	NOM	MAX	MIN	NOM	MAX	
V_{CC}	Supply voltage	4.5	5	5.5	4.5	5	5.5	V
V_{IH}	High-level input voltage	2			2			V
V_{IL}	Low-level input voltage			0.7			0.8	V
I_{OH}	High-level output current			-12			-15	mA
I_{OL}	Low-level output current			12			24	mA
T_A	Operating free-air temperature	-55		125	0		70	°C

electrical characteristics over recommended operating free-air temperature range (unless otherwise noted)

PARAMETER	TEST CONDITIONS	SN54ALS805A			SN74ALS805A			UNIT
		MIN	TYP‡	MAX	MIN	TYP‡	MAX	
V_{IK}	$V_{CC} = 4.5\text{ V}$, $I_I = -18\text{ mA}$			-1.2			-1.2	V
V_{OH}	$V_{CC} = 4.5\text{ V to } 5.5\text{ V}$, $I_{OH} = -0.4\text{ mA}$	$V_{CC} - 2$			$V_{CC} - 2$			V
	$V_{CC} = 4.5\text{ V}$	$I_{OH} = -3\text{ mA}$	2.4	3.2	2.4	3.2		
		$I_{OH} = -12\text{ mA}$	2		2			
V_{OL}	$V_{CC} = 4.5\text{ V}$	$I_{OL} = 12\text{ mA}$	0.25	0.4	0.25	0.4	V	
		$I_{OL} = 24\text{ mA}$			0.35	0.5		
I_I	$V_{CC} = 5.5\text{ V}$, $V_I = 7\text{ V}$			0.1			0.1	mA
I_{IH}	$V_{CC} = 5.5\text{ V}$, $V_I = 2.7\text{ V}$			20			20	μA
I_{IL}	$V_{CC} = 5.5\text{ V}$, $V_I = 0.4\text{ V}$			-0.1			-0.1	mA
I_{O}^{\S}	$V_{CC} = 5.5\text{ V}$, $V_O = 2.25\text{ V}$	-20		-112	-30		-112	mA
I_{CCH}	$V_{CC} = 5.5\text{ V}$, $V_I = 0$		2	4	2	4		mA
I_{CCL}	$V_{CC} = 5.5\text{ V}$, $V_I = 4.5\text{ V}$		8	14	8	14		mA

‡ All typical values are at $V_{CC} = 5\text{ V}$, $T_A = 25^\circ\text{C}$.

§ The output conditions have been chosen to produce a current that closely approximates one half of the true short-circuit output current, I_{OS} .

SN54ALS805A, SN54AS805B, SN74ALS805A, SN74AS805B HEX 2-INPUT NOR DRIVERS

SDAS023C – DECEMBER 1982 – REVISED JANUARY 1995

switching characteristics (see Figure 1)

PARAMETER	FROM (INPUT)	TO (OUTPUT)	V _{CC} = 4.5 V to 5.5 V, C _L = 50 pF, R _L = 500 Ω, T _A = MIN to MAX†				UNIT
			SN54ALS805A		SN74ALS805A		
			MIN	MAX	MIN	MAX	
t _{PLH}	A or B	Y	1	12	2	7	ns
t _{PHL}			1	9	2	8	

† For conditions shown as MIN or MAX, use the appropriate value specified under recommended operating conditions.

absolute maximum ratings over operating free-air temperature range (unless otherwise noted)‡

Supply voltage, V _{CC}	7 V
Input voltage, V _I	7 V
Operating free-air temperature range, T _A : SN54AS805B	–55°C to 125°C
SN74AS805B	0°C to 70°C
Storage temperature range	–65°C to 150°C

‡ Stresses beyond those listed under “absolute maximum ratings” may cause permanent damage to the device. These are stress ratings only, and functional operation of the device at these or any other conditions beyond those indicated under “recommended operating conditions” is not implied. Exposure to absolute-maximum-rated conditions for extended periods may affect device reliability.

recommended operating conditions§

	SN54AS805B			SN74AS805B			UNIT
	MIN	NOM	MAX	MIN	NOM	MAX	
V _{CC} Supply voltage	4.5	5	5.5	4.5	5	5.5	V
V _{IH} High-level input voltage	2			2			V
V _{IL} Low-level input voltage			0.8			0.8	V
I _{OH} High-level output current			–40			–48	mA
I _{OL} Low-level output current			40			48	mA
T _A Operating free-air temperature	–55		125	0		70	°C

§ These high sink- or source-current devices are not recommended for use above 40 MHz.



SN54ALS805A, SN54AS805B, SN74ALS805A, SN74AS805B HEX 2-INPUT NOR DRIVERS

SDAS023C – DECEMBER 1982 – REVISED JANUARY 1995

electrical characteristics over recommended operating free-air temperature range (unless otherwise noted)

PARAMETER	TEST CONDITIONS		SN54AS805B		SN74AS805B		UNIT	
			MIN	TYP†	MAX	MIN		TYP†
V_{IK}	$V_{CC} = 4.5 V$,	$I_I = -18 mA$			-1.2	-1.2	V	
V_{OH}	$V_{CC} = 4.5 V$ to $5.5 V$,	$I_{OH} = -2 mA$	$V_{CC} - 2$		$V_{CC} - 2$		V	
	$V_{CC} = 4.5 V$	$I_{OH} = -3 mA$	2.4	3.2	2.4	3.2		
		$I_{OH} = -40 mA$	2		2			
V_{OL}	$V_{CC} = 4.5 V$	$I_{OL} = 40 mA$	0.25 0.5				V	
		$I_{OL} = 48 mA$			0.35	0.5		
I_I	$V_{CC} = 5.5 V$,	$V_I = 7 V$			0.1	0.1	mA	
I_{IH}	$V_{CC} = 5.5 V$,	$V_I = 2.7 V$			20	20	μA	
I_{IL}	$V_{CC} = 5.5 V$,	$V_I = 0.4 V$			-0.5	-0.5	mA	
$I_{O\ddagger}$	$V_{CC} = 5.5 V$,	$V_O = 2.25 V$	-50		-200	-200	mA	
I_{CCH}	$V_{CC} = 5.5 V$,	$V_I = 0$		6.5	10	6.5	10	mA
I_{CCL}	$V_{CC} = 5.5 V$,	$V_I = 4.5 V$		20	32	20	32	mA

† All typical values are at $V_{CC} = 5 V$, $T_A = 25^\circ C$.

‡ The output conditions have been chosen to produce a current that closely approximates one half of the true short-circuit output current, I_{OS} .

switching characteristics (see Figure 1)

PARAMETER	FROM (INPUT)	TO (OUTPUT)	$V_{CC} = 4.5 V$ to $5.5 V$, $C_L = 50 pF$, $R_L = 500 \Omega$, $T_A = MIN$ to MAX §				UNIT
			SN54AS805B		SN74AS805B		
			MIN	MAX	MIN	MAX	
t_{PLH}	A or B	Y	1	4.8	1	4.3	ns
t_{PHL}			1	4.8	1	4.3	

§ For conditions shown as MIN or MAX, use the appropriate value specified under recommended operating conditions.



PARAMETER MEASUREMENT INFORMATION
SERIES 54ALS/74ALS AND 54AS/74AS DEVICES

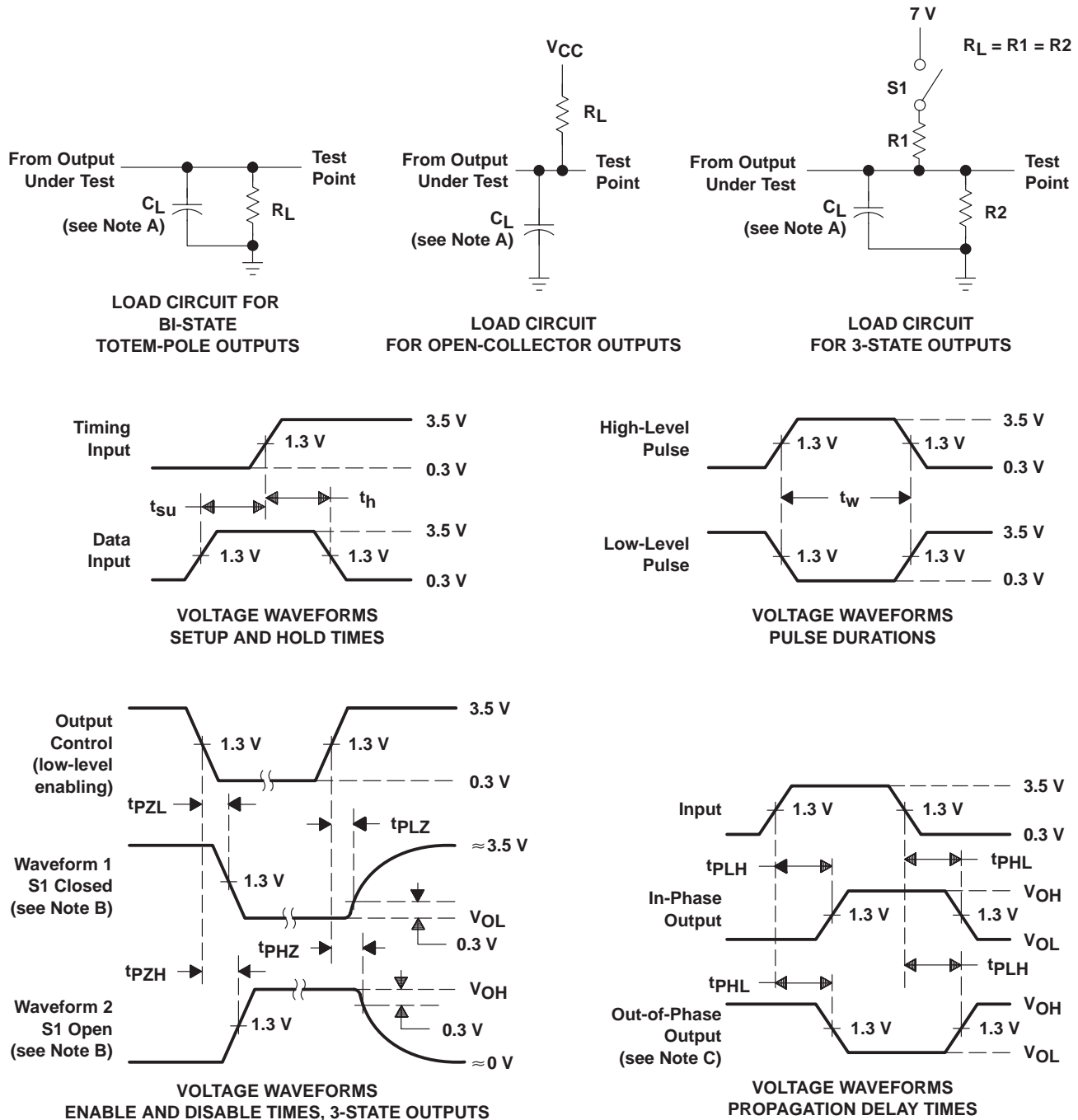

- NOTES: A. C_L includes probe and jig capacitance.
 B. Waveform 1 is for an output with internal conditions such that the output is low except when disabled by the output control. Waveform 2 is for an output with internal conditions such that the output is high except when disabled by the output control.
 C. When measuring propagation delay items of 3-state outputs, switch S1 is open.
 D. All input pulses have the following characteristics: PRR \leq 1 MHz, $t_r = t_f = 2$ ns, duty cycle = 50%.
 E. The outputs are measured one at a time with one transition per measurement.

Figure 1. Load Circuits and Voltage Waveforms

PACKAGING INFORMATION

Orderable Device	Status ⁽¹⁾	Package Type	Package Drawing	Pins	Package Qty	Eco Plan ⁽²⁾	Lead/Ball Finish	MSL Peak Temp ⁽³⁾	Samples (Requires Login)
5962-87794012A	ACTIVE	LCCC	FK	20	1	TBD	POST-PLATE	N / A for Pkg Type	Purchase Samples
5962-8779401RA	ACTIVE	CDIP	J	20	1	TBD	A42	N / A for Pkg Type	Purchase Samples
5962-8779401SA	ACTIVE	CFP	W	20	1	TBD	Call TI	N / A for Pkg Type	Purchase Samples
5962-8869401SA	OBSOLETE	CFP	W	20		TBD	Call TI	Call TI	Samples Not Available
SN54ALS805AJ	OBSOLETE	CDIP	J	20		TBD	Call TI	Call TI	
SN74ALS805ADWR	ACTIVE	SOIC	DW	20	2000	Green (RoHS & no Sb/Br)	CU NIPDAU	Level-1-260C-UNLIM	Purchase Samples
SN74ALS805ADWRE4	ACTIVE	SOIC	DW	20	2000	Green (RoHS & no Sb/Br)	CU NIPDAU	Level-1-260C-UNLIM	Purchase Samples
SN74ALS805ADWRG4	ACTIVE	SOIC	DW	20	2000	Green (RoHS & no Sb/Br)	CU NIPDAU	Level-1-260C-UNLIM	Purchase Samples
SN74ALS805AN3	OBSOLETE	PDIP	N	20		TBD	Call TI	Call TI	Samples Not Available
SN74AS805BDW	NRND	SOIC	DW	20	25	Green (RoHS & no Sb/Br)	CU NIPDAU	Level-1-260C-UNLIM	Samples Not Available
SN74AS805BDWE4	NRND	SOIC	DW	20	25	Green (RoHS & no Sb/Br)	CU NIPDAU	Level-1-260C-UNLIM	Samples Not Available
SN74AS805BDWG4	NRND	SOIC	DW	20	25	Green (RoHS & no Sb/Br)	CU NIPDAU	Level-1-260C-UNLIM	Samples Not Available
SN74AS805BN	NRND	PDIP	N	20	20	Pb-Free (RoHS)	CU NIPDAU	N / A for Pkg Type	Samples Not Available
SN74AS805BNE4	NRND	PDIP	N	20	20	Pb-Free (RoHS)	CU NIPDAU	N / A for Pkg Type	Samples Not Available
SNJ54ALS805AFK	OBSOLETE	LCCC	FK	20		TBD	Call TI	Call TI	Replaced by SNJ54AS805BFK
SNJ54ALS805AJ	OBSOLETE	CDIP	J	20		TBD	Call TI	Call TI	Replaced by SNJ54AS805BJ
SNJ54AS805BFK	ACTIVE	LCCC	FK	20	1	TBD	POST-PLATE	N / A for Pkg Type	Purchase Samples
SNJ54AS805BJ	ACTIVE	CDIP	J	20	1	TBD	A42	N / A for Pkg Type	Purchase Samples
SNJ54AS805BW	ACTIVE	CFP	W	20	1	TBD	Call TI	N / A for Pkg Type	Purchase Samples

⁽¹⁾ The marketing status values are defined as follows:

ACTIVE: Product device recommended for new designs.

LIFEBUY: TI has announced that the device will be discontinued, and a lifetime-buy period is in effect.

NRND: Not recommended for new designs. Device is in production to support existing customers, but TI does not recommend using this part in a new design.

PREVIEW: Device has been announced but is not in production. Samples may or may not be available.

OBSOLETE: TI has discontinued the production of the device.

⁽²⁾ Eco Plan - The planned eco-friendly classification: Pb-Free (RoHS), Pb-Free (RoHS Exempt), or Green (RoHS & no Sb/Br) - please check <http://www.ti.com/productcontent> for the latest availability information and additional product content details.

TBD: The Pb-Free/Green conversion plan has not been defined.

Pb-Free (RoHS): TI's terms "Lead-Free" or "Pb-Free" mean semiconductor products that are compatible with the current RoHS requirements for all 6 substances, including the requirement that lead not exceed 0.1% by weight in homogeneous materials. Where designed to be soldered at high temperatures, TI Pb-Free products are suitable for use in specified lead-free processes.

Pb-Free (RoHS Exempt): This component has a RoHS exemption for either 1) lead-based flip-chip solder bumps used between the die and package, or 2) lead-based die adhesive used between the die and leadframe. The component is otherwise considered Pb-Free (RoHS compatible) as defined above.

Green (RoHS & no Sb/Br): TI defines "Green" to mean Pb-Free (RoHS compatible), and free of Bromine (Br) and Antimony (Sb) based flame retardants (Br or Sb do not exceed 0.1% by weight in homogeneous material)

⁽³⁾ MSL, Peak Temp. -- The Moisture Sensitivity Level rating according to the JEDEC industry standard classifications, and peak solder temperature.

Important Information and Disclaimer: The information provided on this page represents TI's knowledge and belief as of the date that it is provided. TI bases its knowledge and belief on information provided by third parties, and makes no representation or warranty as to the accuracy of such information. Efforts are underway to better integrate information from third parties. TI has taken and continues to take reasonable steps to provide representative and accurate information but may not have conducted destructive testing or chemical analysis on incoming materials and chemicals. TI and TI suppliers consider certain information to be proprietary, and thus CAS numbers and other limited information may not be available for release.

In no event shall TI's liability arising out of such information exceed the total purchase price of the TI part(s) at issue in this document sold by TI to Customer on an annual basis.

OTHER QUALIFIED VERSIONS OF SN54ALS805A, SN54AS805B, SN74ALS805A, SN74AS805B :

● Catalog: [SN74ALS805A](#), [SN74AS805B](#)

● Military: [SN54ALS805A](#), [SN54AS805B](#)

NOTE: Qualified Version Definitions:

● Catalog - TI's standard catalog product

● Military - QML certified for Military and Defense Applications

TAPE AND REEL INFORMATION

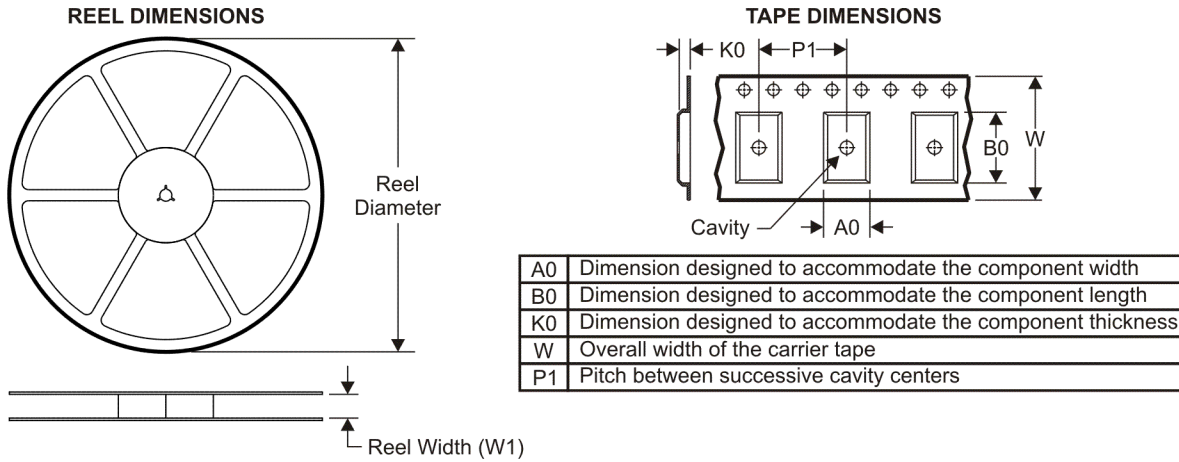

QUADRANT ASSIGNMENTS FOR PIN 1 ORIENTATION IN TAPE

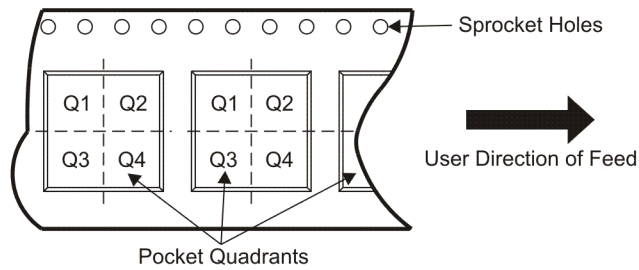

*All dimensions are nominal

Device	Package Type	Package Drawing	Pins	SPQ	Reel Diameter (mm)	Reel Width W1 (mm)	A0 (mm)	B0 (mm)	K0 (mm)	P1 (mm)	W (mm)	Pin1 Quadrant
SN74ALS805ADWR	SOIC	DW	20	2000	330.0	24.4	10.8	13.0	2.7	12.0	24.0	Q1

TAPE AND REEL BOX DIMENSIONS



*All dimensions are nominal

Device	Package Type	Package Drawing	Pins	SPQ	Length (mm)	Width (mm)	Height (mm)
SN74ALS805ADWR	SOIC	DW	20	2000	346.0	346.0	41.0

J (R-GDIP-T**)

14 LEADS SHOWN

CERAMIC DUAL IN-LINE PACKAGE



DIM \ PINS **	14	16	18	20
A	0.300 (7,62) BSC	0.300 (7,62) BSC	0.300 (7,62) BSC	0.300 (7,62) BSC
B MAX	0.785 (19,94)	.840 (21,34)	0.960 (24,38)	1.060 (26,92)
B MIN	—	—	—	—
C MAX	0.300 (7,62)	0.300 (7,62)	0.310 (7,87)	0.300 (7,62)
C MIN	0.245 (6,22)	0.245 (6,22)	0.220 (5,59)	0.245 (6,22)



4040083/F 03/03

- NOTES:
- All linear dimensions are in inches (millimeters).
 - This drawing is subject to change without notice.
 - This package is hermetically sealed with a ceramic lid using glass frit.
 - Index point is provided on cap for terminal identification only on press ceramic glass frit seal only.
 - Falls within MIL STD 1835 GDIP1-T14, GDIP1-T16, GDIP1-T18 and GDIP1-T20.

W (R-GDFP-F20)

CERAMIC DUAL FLATPACK



- NOTES:
- A. All linear dimensions are in inches (millimeters).
 - B. This drawing is subject to change without notice.
 - C. This package can be hermetically sealed with a ceramic lid using glass frit.
 - D. Index point is provided on cap for terminal identification only.
 - E. Falls within Mil-Std 1835 GDFP2-F20

FK (S-CQCC-N**)

LEADLESS CERAMIC CHIP CARRIER

28 TERMINAL SHOWN



NO. OF TERMINALS **	A		B	
	MIN	MAX	MIN	MAX
20	0.342 (8,69)	0.358 (9,09)	0.307 (7,80)	0.358 (9,09)
28	0.442 (11,23)	0.458 (11,63)	0.406 (10,31)	0.458 (11,63)
44	0.640 (16,26)	0.660 (16,76)	0.495 (12,58)	0.560 (14,22)
52	0.740 (18,78)	0.761 (19,32)	0.495 (12,58)	0.560 (14,22)
68	0.938 (23,83)	0.962 (24,43)	0.850 (21,6)	0.858 (21,8)
84	1.141 (28,99)	1.165 (29,59)	1.047 (26,6)	1.063 (27,0)



4040140/D 01/11

- NOTES:
- All linear dimensions are in inches (millimeters).
 - This drawing is subject to change without notice.
 - This package can be hermetically sealed with a metal lid.
 - Falls within JEDEC MS-004

N (R-PDIP-T**)

PLASTIC DUAL-IN-LINE PACKAGE

16 PINS SHOWN



- NOTES:
- A. All linear dimensions are in inches (millimeters).
 - B. This drawing is subject to change without notice.
 - (C) Falls within JEDEC MS-001, except 18 and 20 pin minimum body length (Dim A).
 - (D) The 20 pin end lead shoulder width is a vendor option, either half or full width.

DW (R-PDSO-G20)

PLASTIC SMALL OUTLINE

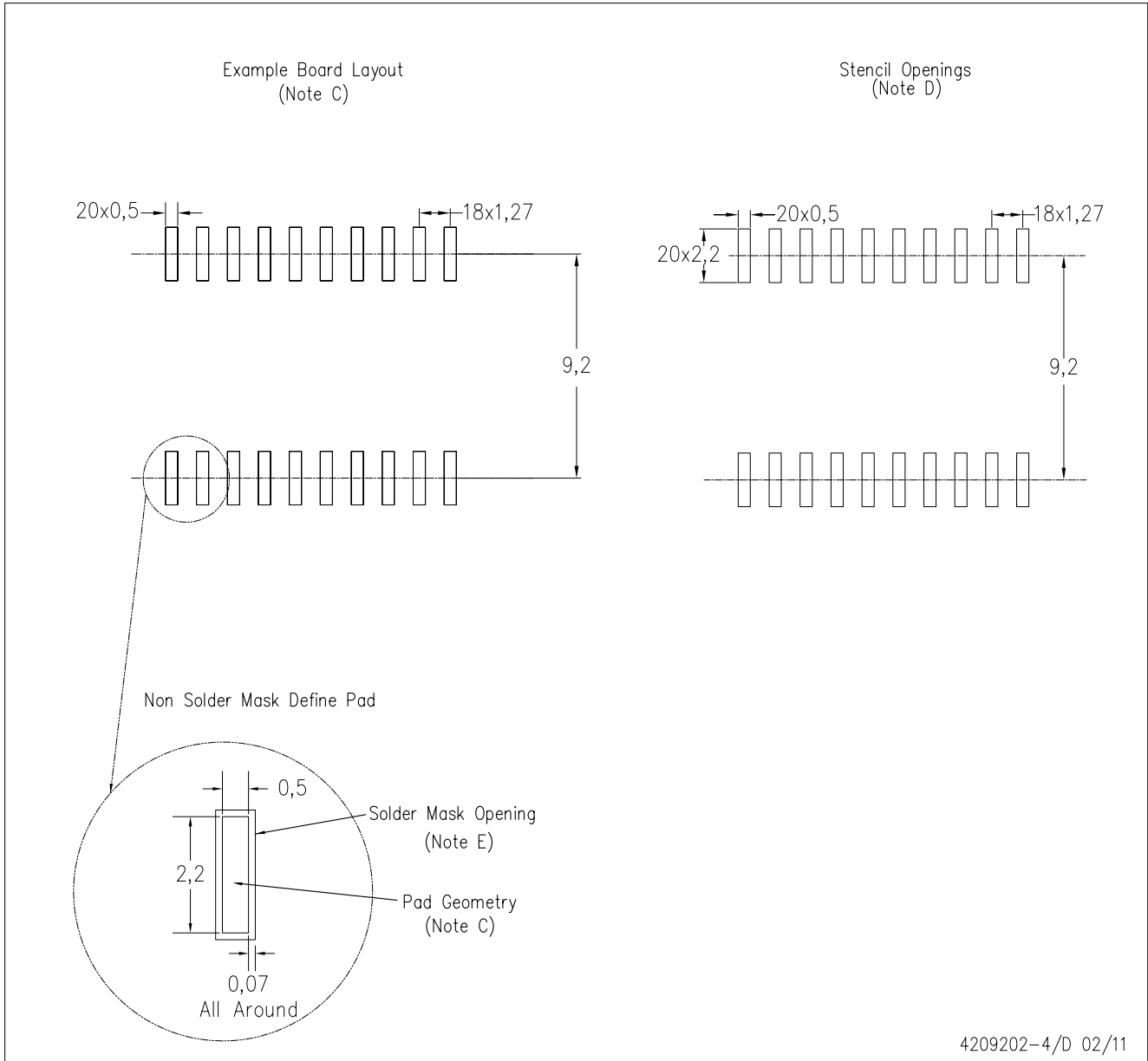

4209202-4/D 02/11

- NOTES:
- A. All linear dimensions are in millimeters.
 - B. This drawing is subject to change without notice.
 - C. Customers should place a note on the circuit board fabrication drawing not to alter the center solder mask defined pad.
 - D. Laser cutting apertures with trapezoidal walls and also rounding corners will offer better paste release. Customers should contact their board assembly site for stencil design recommendations. Refer to IPC-7525
 - E. Customers should contact their board fabrication site for solder mask tolerances between and around signal pads.

IMPORTANT NOTICE

Texas Instruments Incorporated and its subsidiaries (TI) reserve the right to make corrections, modifications, enhancements, improvements, and other changes to its products and services at any time and to discontinue any product or service without notice. Customers should obtain the latest relevant information before placing orders and should verify that such information is current and complete. All products are sold subject to TI's terms and conditions of sale supplied at the time of order acknowledgment.

TI warrants performance of its hardware products to the specifications applicable at the time of sale in accordance with TI's standard warranty. Testing and other quality control techniques are used to the extent TI deems necessary to support this warranty. Except where mandated by government requirements, testing of all parameters of each product is not necessarily performed.

TI assumes no liability for applications assistance or customer product design. Customers are responsible for their products and applications using TI components. To minimize the risks associated with customer products and applications, customers should provide adequate design and operating safeguards.

TI does not warrant or represent that any license, either express or implied, is granted under any TI patent right, copyright, mask work right, or other TI intellectual property right relating to any combination, machine, or process in which TI products or services are used. Information published by TI regarding third-party products or services does not constitute a license from TI to use such products or services or a warranty or endorsement thereof. Use of such information may require a license from a third party under the patents or other intellectual property of the third party, or a license from TI under the patents or other intellectual property of TI.

Reproduction of TI information in TI data books or data sheets is permissible only if reproduction is without alteration and is accompanied by all associated warranties, conditions, limitations, and notices. Reproduction of this information with alteration is an unfair and deceptive business practice. TI is not responsible or liable for such altered documentation. Information of third parties may be subject to additional restrictions.

Resale of TI products or services with statements different from or beyond the parameters stated by TI for that product or service voids all express and any implied warranties for the associated TI product or service and is an unfair and deceptive business practice. TI is not responsible or liable for any such statements.

TI products are not authorized for use in safety-critical applications (such as life support) where a failure of the TI product would reasonably be expected to cause severe personal injury or death, unless officers of the parties have executed an agreement specifically governing such use. Buyers represent that they have all necessary expertise in the safety and regulatory ramifications of their applications, and acknowledge and agree that they are solely responsible for all legal, regulatory and safety-related requirements concerning their products and any use of TI products in such safety-critical applications, notwithstanding any applications-related information or support that may be provided by TI. Further, Buyers must fully indemnify TI and its representatives against any damages arising out of the use of TI products in such safety-critical applications.

TI products are neither designed nor intended for use in military/aerospace applications or environments unless the TI products are specifically designated by TI as military-grade or "enhanced plastic." Only products designated by TI as military-grade meet military specifications. Buyers acknowledge and agree that any such use of TI products which TI has not designated as military-grade is solely at the Buyer's risk, and that they are solely responsible for compliance with all legal and regulatory requirements in connection with such use.

TI products are neither designed nor intended for use in automotive applications or environments unless the specific TI products are designated by TI as compliant with ISO/TS 16949 requirements. Buyers acknowledge and agree that, if they use any non-designated products in automotive applications, TI will not be responsible for any failure to meet such requirements.

Following are URLs where you can obtain information on other Texas Instruments products and application solutions:

Products

Audio	www.ti.com/audio
Amplifiers	amplifier.ti.com
Data Converters	dataconverter.ti.com
DLP® Products	www.dlp.com
DSP	dsp.ti.com
Clocks and Timers	www.ti.com/clocks
Interface	interface.ti.com
Logic	logic.ti.com
Power Mgmt	power.ti.com
Microcontrollers	microcontroller.ti.com
RFID	www.ti-rfid.com
RF/IF and ZigBee® Solutions	www.ti.com/lprf

Applications

Communications and Telecom	www.ti.com/communications
Computers and Peripherals	www.ti.com/computers
Consumer Electronics	www.ti.com/consumer-apps
Energy and Lighting	www.ti.com/energy
Industrial	www.ti.com/industrial
Medical	www.ti.com/medical
Security	www.ti.com/security
Space, Avionics and Defense	www.ti.com/space-avionics-defense
Transportation and Automotive	www.ti.com/automotive
Video and Imaging	www.ti.com/video
Wireless	www.ti.com/wireless-apps

TI E2E Community Home Page

e2e.ti.com

Mailing Address: Texas Instruments, Post Office Box 655303, Dallas, Texas 75265
Copyright © 2011, Texas Instruments Incorporated