

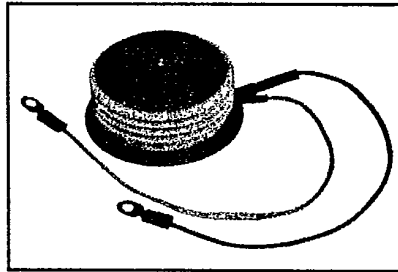

T820

Powerex, Inc. Hillis Street, Youngwood, Pennsylvania 15697 (412) 925-7272
 Powerex Europe, S.A., 428 Ave. G. Durand, BP107, 72003 LeMans, France (43) 72.75.15

Phase Control SCR
500-600 Amperes Avg
2200-4200 Volts

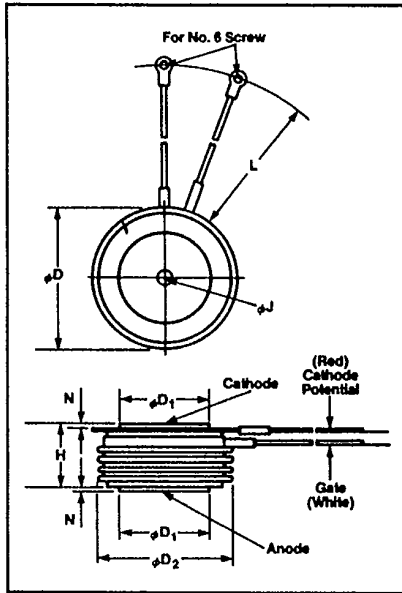

T820
Phase Control SCR
 500-600 Amperes/2200-4200 Volts

Description

Powerex Silicon Controlled Rectifiers (SCR) are designed for phase control applications. These are all-diffused, Press-Pak (Pow-R-Disc) devices employing the field-proven amplifying (di/namic) gate.

Features:

- Low On-State Voltage
- High di/dt
- High dv/dt
- Hermetic Packaging
- Excellent Surge and I²t Ratings

Applications:

- Power Supplies
- Battery Chargers
- Motor Control
- Light Dimmers
- VAR Generators

Ordering Information

Example: Select the complete eight digit part number you desire from the table - i.e. T8203050 is a 3000 Volt, 500 Ampere Phase Control SCR.

T82
Outline Drawing

Dimensions	Inches		Millimeters	
	Min.	Max.	Min.	Max.
φD	2.250	2.290	57.15	58.17
φD ₁	1.333	1.343	33.86	34.11
φD ₂	2.030	2.090	51.56	53.09
H	1.020	1.060	25.91	26.92
φJ	.135	.145	3.43	3.68
L	11.50	12.50	292.10	317.50
N	.040	—	1.02	—

Creep Distance—1.00 in. min. (25.40 mm)
 Strike Distance—.89 in. min. (17.53 mm).
 (In accordance with NEMA standards.)
 Finish—Nickel Plate.
 Approx. Weight—8 oz. (227 g).
 1. Dimension "H" is clamped dimension.

Type	Voltage*		Current	
	V _{ORM}	V _{RRM} Code	I _T (avg)	Code
T820	2200	22	500	50
	2400	24	600	60
	2600	26		
	2800	28		
	3000	30		
	3200	32		
	3400	34		
	3600	36		
	3800	38		
	4000	40		
	4200	42		

*All voltages not available in all current ratings.



T-25-20

Powerex, Inc., Hills Street, Youngwood, Pennsylvania 15697 (412) 925-7272

Powerex Europe, S.A., 428 Ave. G. Durand, BP107, 72003 LeMans, France (43) 72.75.15

T820

Phase Control SCR

500-600 Amperes Avg/2200-4200 Volts

Absolute Maximum Ratings

	Symbol	T820 _ _ 50	T820 _ _ 60	Units
Maximum Blocking Voltage	V_{DRM}, V_{RRM}	4200	3800	Volts
RMS On-State Current	$I_{T(RMS)}$	785	940	Amperes
Average On-State Current	$I_{T(av)}$	500	600	Amperes
Peak One-Cycle Surge (Non-Repetitive) On-State Current (60Hz) [ⓐ]	I_{TSM}	6,000	10,500	Amperes
Peak One-Cycle Surge (Non-Repetitive) On-State Current (50Hz) [ⓐ]	I_{TSM}	5,475	9,580	Amperes
Critical Rate-of-Rise of On-State Current (Non-Repetitive) ^{ⓐⓑ}	di/dt	100	400	Amperes/ μ s
Critical Rate-of-Rise of On-State Current (Repetitive)	di/dt	30	150	Amperes/ μ s
I^2t (for Fusing), One Cycle at 60Hz	I^2t	150,000	459,000	A ² sec
Peak Gate Power Dissipation	P_{GM}	16	16	Watts
Average Gate Power Dissipation	$P_{G(av)}$	3	3	Watts
Storage Temperature	T_{STG}	-40 to 150	-40 to 150	°C
Operating Temperature	T_J	-40 to 125	-40 to 125	°C
Mounting Force [ⓐ]		3000 to 3500	3000 to 3500	lb.
Mounting Force [ⓐ]		1360 to 1590	1360 to 1590	kg

Electrical and Thermal Characteristics

	Symbol	Test Conditions	T820 _ _ 50	T820 _ _ 60	Units
Voltage—Blocking State Maximums[ⓐ]					
Forward Leakage, Peak	I_{DRM}	$T_J = 125^\circ\text{C}, V_{DRM} = \text{rated}$	65	35	mA
Reverse Leakage, Peak	I_{RRM}	$T_J = 125^\circ\text{C}, V_{RRM} = \text{rated}$	65	35	mA
Current—Conducting State Maximums					
Peak On-State Voltage	V_{TM}	$I_{TM} = 1500\text{A}, T_J = 25^\circ\text{C}$	2.3	2.0	Volts
Threshold Voltage	$V_{(TO)}$	$T_J = 125^\circ\text{C}$.85	.74	Volts
Slope Resistance	r_T	$T_J = 125^\circ\text{C}$	1.1	1.06	mOhm

T820

Switching					
Typical Turn-Off Time	t_q	$I_T = 250\text{A}, T_J = 125^\circ\text{C}, di/dt = 50\text{A}/\mu\text{sec},$ reapplied $dv/dt = 20\text{V}/\mu\text{sec}$ linear to $0.8V_{DRM}$	200		μsec
Typical Turn-On Time [ⓐ]	t_{on}	$I_{TM} = 1000\text{A}, V_D = 600\text{V}$	5.0		μsec
Min. Critical dv/dt exponential to V_{DRM} [ⓐ]	dv/dt	$T_J = 125^\circ\text{C}$	300		$\text{V}/\mu\text{sec}$

Thermal

Maximum Thermal Resistance, [ⓐ] double sided cooling					
Junction to Case	$R_{\theta JC}$.037		°C/Watt
Case to Sink, Lubricated	$R_{\theta CS}$.020		°C/Watt

Gate—Maximum Parameters

Gate Current to Trigger	I_{GT}	$T_J = 25^\circ\text{C}, V_D = 12\text{V}$	150		mA
Gate Voltage to Trigger	V_{GT}	$T_J = 25^\circ\text{C}, V_D = 12\text{V}$	3.0		Volts
Non-Triggering Gate Voltage	V_{GDM}	$T_J = 125^\circ\text{C}, \text{rated } V_{DRM}$.15		Volts
Peak Forward Gate Current	I_{GTM}		4		Amperes
Peak Reverse Gate Voltage	V_{GRM}		5		Volts

ⓐ Consult recommended mounting procedures.

ⓑ Applies for zero or negative gate bias.

Ⓒ Per JEDEC RS-397, 5.2.2.1.

ⓐ With recommended gate drive.

ⓑ Higher dv/dt ratings available, consult factory.

Ⓒ Per JEDEC standard RS-397, 5.2.2.6.



T-25-20

Powerex, Inc., Hillis Street, Youngwood, Pennsylvania 15697 (412) 925-7272
 Powerex Europe, S.A., 428 Ave. G. Durand, BP107, 72003 LeMans, France (43) 72.75.15

T820
Phase Control SCR
 500-600 Amperes Avg/2200-4200 Volts

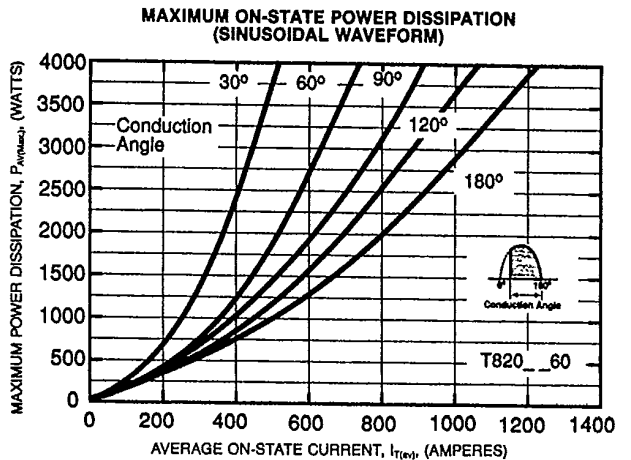
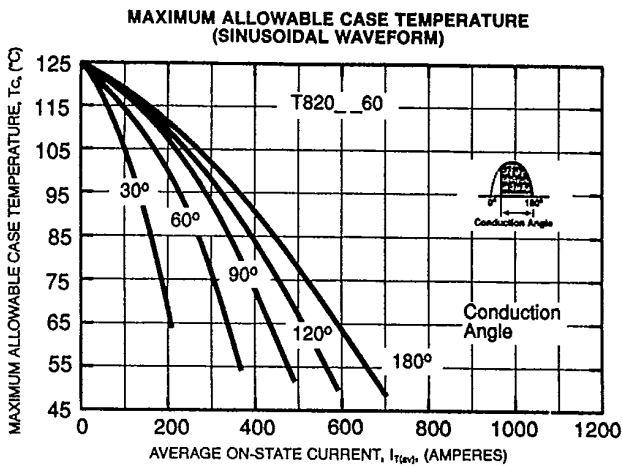
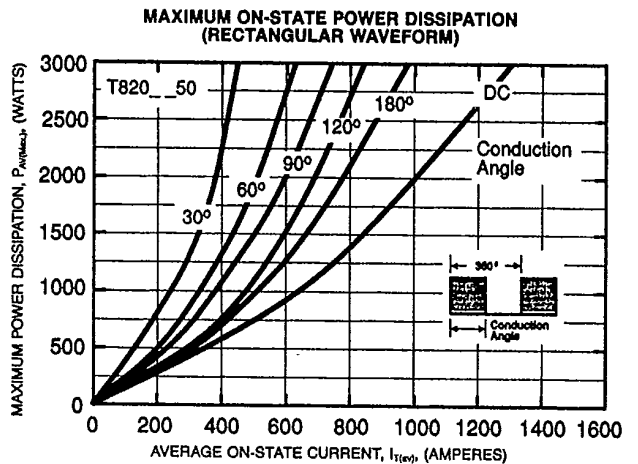
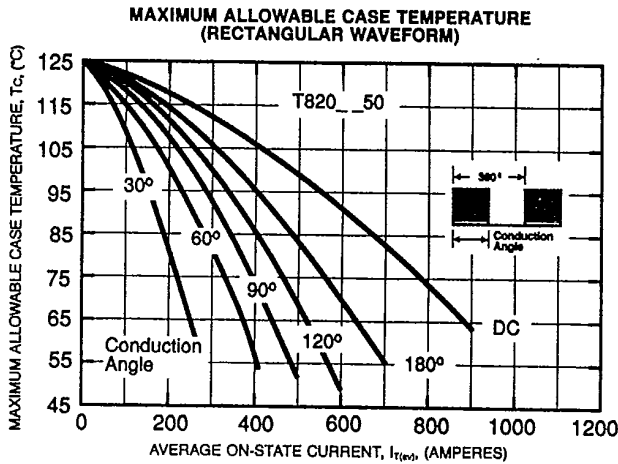
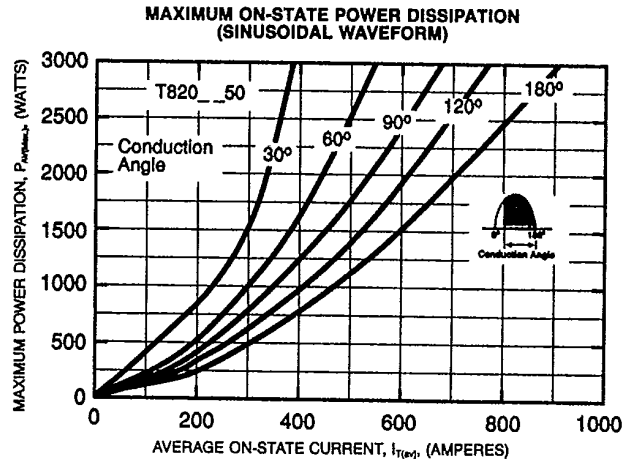
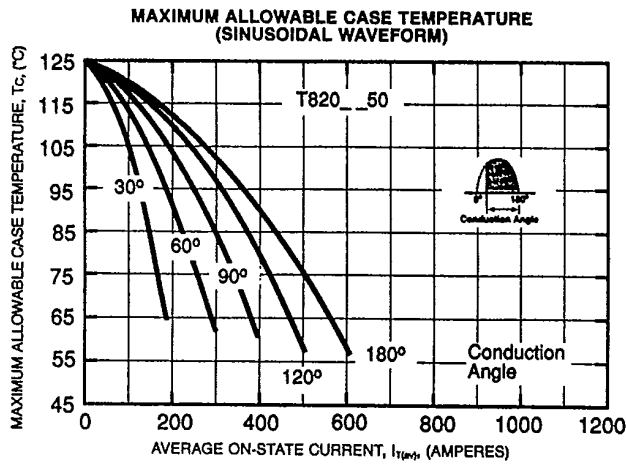



T-25-20

Powerex, Inc., Hillis Street, Youngwood, Pennsylvania 15697 (412) 925-7272
 Powerex Europe, S.A., 428 Ave. G. Durand, BP107, 72003 LeMans, France (43) 72.75.15

T820
 Phase Control SCR
 500-600 Amperes Avg/2200-4200 Volts

