

DATA SHEET

BLV20 VHF power transistor

Product specification

August 1986

VHF power transistor

BLV20

DESCRIPTION

N-P-N silicon planar epitaxial transistor intended for use in class-A, B and C operated h.f. and v.h.f. transmitters with a nominal supply voltage of 28 V. The transistor is resistance stabilized and is guaranteed to withstand severe load mismatch conditions.

It has a 3/8" flange envelope with a ceramic cap. All leads are isolated from the flange.

PINNING - SOT123

| PIN | DESCRIPTION |
|-----|-------------|
| 1 | collector |
| 2 | emitter |
| 3 | base |
| 4 | emitter |

QUICK REFERENCE DATA

R.F. performance up to $T_h = 25\text{ }^\circ\text{C}$ in an unneutralized common-emitter class-B circuit

| MODE OF OPERATION | V_{CE} V | f MHz | P_L W | G_p dB | η % | \bar{z}_i Ω | \bar{Y}_L mS |
|-------------------|---------------|----------|------------|-------------|-------------|-------------------------|-------------------|
| c.w. | 28 | 175 | 8 | > 12 | > 65 | $1,8 + j0,7$ | $18 - j20$ |

PIN CONFIGURATION

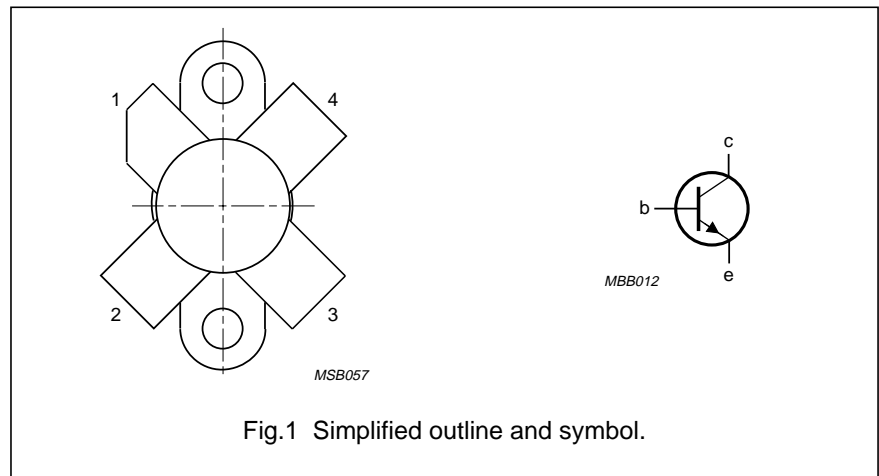

PRODUCT SAFETY This device incorporates beryllium oxide, the dust of which is toxic. The device is entirely safe provided that the BeO disc is not damaged.

VHF power transistor

BLV20

RATINGS

Limiting values in accordance with the Absolute Maximum System (IEC 134)

Collector-emitter voltage ($V_{BE} = 0$)

| | | | |
|---|-------------|------|-----------------|
| peak value | V_{CESM} | max. | 65 V |
| Collector-emitter voltage (open base) | V_{CEO} | max. | 36 V |
| Emitter-base voltage (open collector) | V_{EBO} | max. | 4 V |
| Collector current (average) | $I_{C(AV)}$ | max. | 0,9 A |
| Collector current (peak value); $f > 1$ MHz | I_{CM} | max. | 2,5 A |
| R.F. power dissipation ($f > 1$ MHz); $T_{mb} = 25$ °C | P_{rf} | max. | 20 W |
| Storage temperature | T_{stg} | | -65 to + 150 °C |
| Operating junction temperature | T_j | max. | 200 °C |

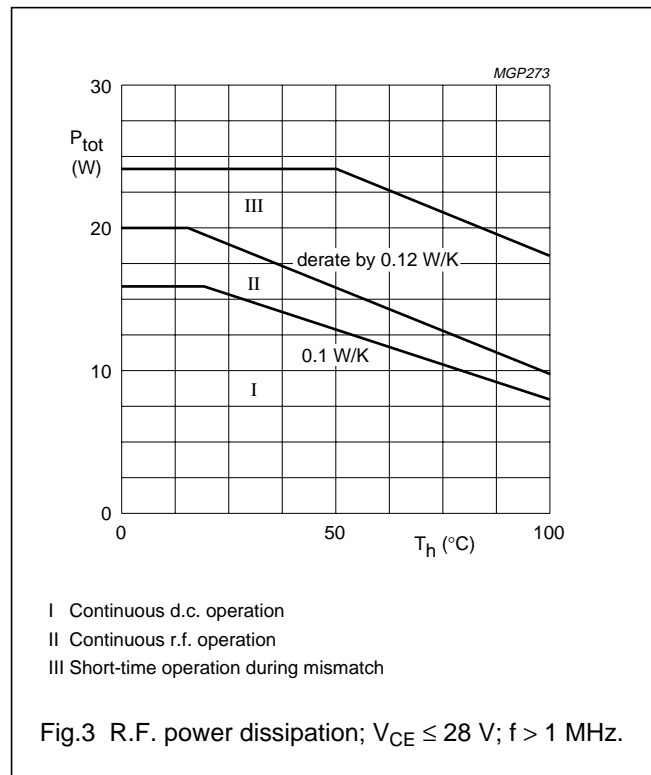
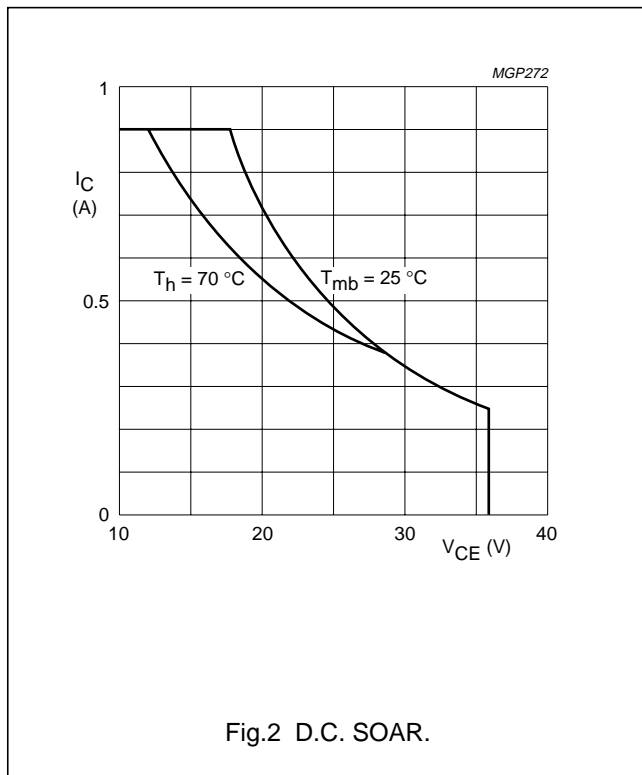

THERMAL RESISTANCE

(dissipation = 8 W; $T_{mb} = 72,4$ °C, i.e. $T_h = 70$ °C)

| | | | |
|---|--------------------|---|----------|
| From junction to mounting base (d.c. dissipation) | $R_{th\ j-mb(dc)}$ | = | 10,7 K/W |
| From junction to mounting base (r.f. dissipation) | $R_{th\ j-mb(rf)}$ | = | 8,6 K/W |
| From mounting base to heatsink | $R_{th\ mb-h}$ | = | 0,3 K/W |

VHF power transistor

BLV20

CHARACTERISTICS $T_j = 25\text{ }^\circ\text{C}$

Collector-emitter breakdown voltage

 $V_{BE} = 0; I_C = 2\text{ mA}$ $V_{(BR)CES} > 65\text{ V}$

Collector-emitter breakdown voltage

open base; $I_C = 10\text{ mA}$ $V_{(BR)CEO} > 36\text{ V}$

Emitter-base breakdown voltage

open collector; $I_E = 1\text{ mA}$ $V_{(BR)EBO} > 4\text{ V}$

Collector cut-off current

 $V_{BE} = 0; V_{CE} = 36\text{ V}$ $I_{CES} < 1\text{ mA}$ Second breakdown energy; $L = 25\text{ mH}; f = 50\text{ Hz}$

open base

 $E_{SBO} > 0,5\text{ mJ}$ $R_{BE} = 10\text{ }\Omega$ $E_{SBR} > 0,5\text{ mJ}$ D.C. current gain ⁽¹⁾ $I_C = 0,4\text{ A}; V_{CE} = 5\text{ V}$ h_{FE} typ. 50
10 to 100Collector-emitter saturation voltage ⁽¹⁾ $I_C = 1,25\text{ A}; I_B = 0,25\text{ A}$ V_{CEsat} typ. 0,8 VTransition frequency at $f = 100\text{ MHz}$ ⁽¹⁾ $-I_E = 0,4\text{ A}; V_{CB} = 28\text{ V}$ f_T typ. 600 MHz $-I_E = 1,25\text{ A}; V_{CB} = 28\text{ V}$ f_T typ. 520 MHzCollector capacitance at $f = 1\text{ MHz}$ $I_E = I_e = 0; V_{CB} = 28\text{ V}$ C_c typ. 10 pFFeedback capacitance at $f = 1\text{ MHz}$ $I_C = 50\text{ mA}; V_{CE} = 28\text{ V}$ C_{re} typ. 7,1 pF

Collector-flange capacitance

 C_{cf} typ. 2 pF**Note**1. Measured under pulse conditions: $t_p \leq 200\text{ }\mu\text{s}; \delta \leq 0,02$.

VHF power transistor

BLV20

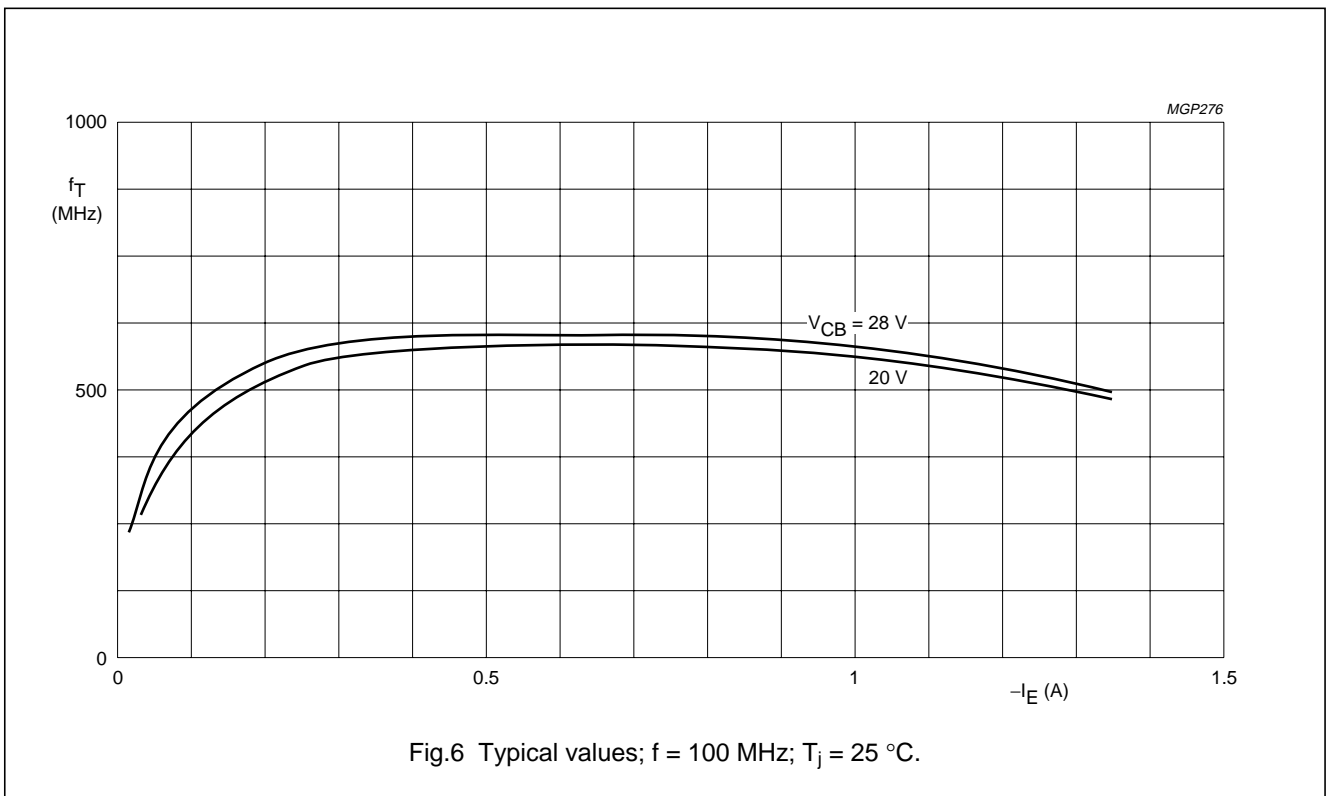
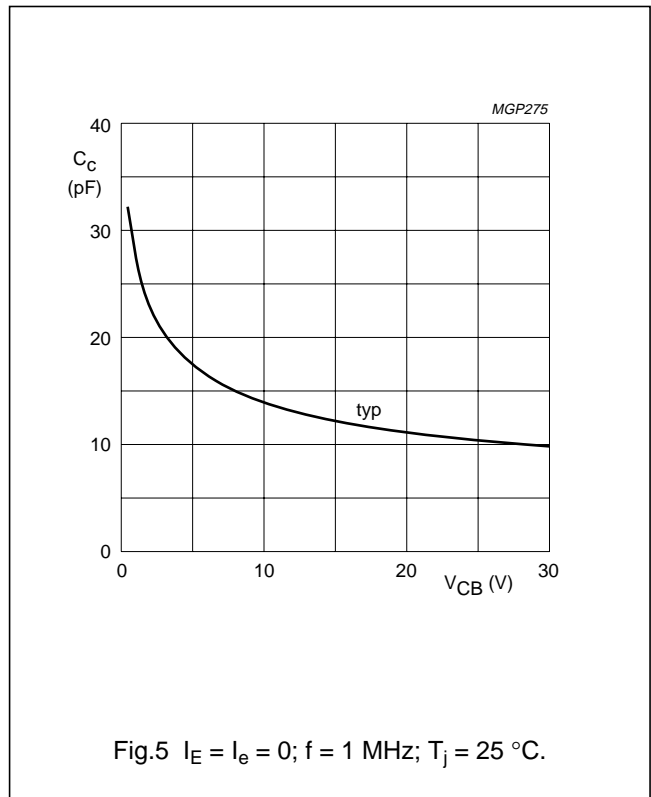
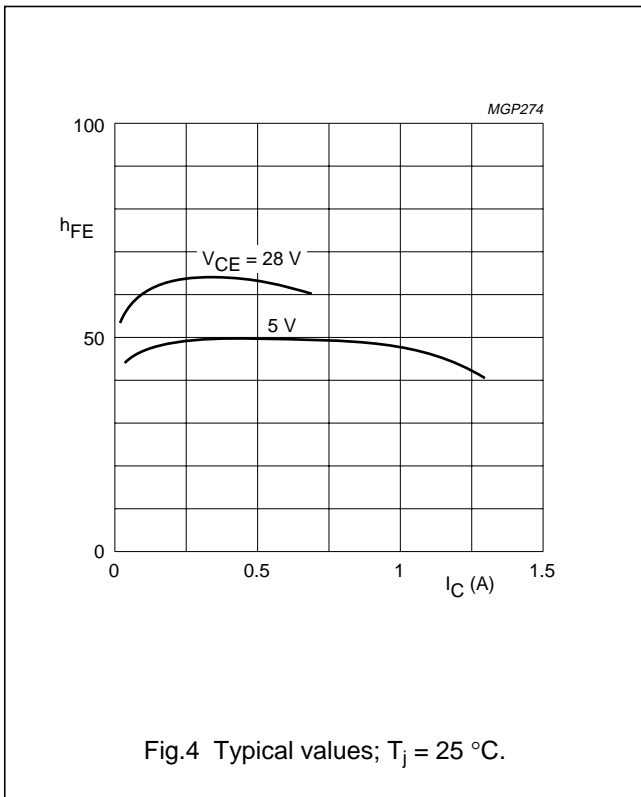

VHF power transistor

BLV20

APPLICATION INFORMATION

R. F. performance in c.w. operation (unneutralized common-emitter class-B circuit)

 $T_h = 25\text{ }^\circ\text{C}$

| f (MHz) | V_{CE} (V) | P_L (W) | P_S (W) | G_p (dB) | I_C (A) | η (%) | \bar{z}_i (Ω) | \bar{Y}_L (mS) |
|---------|--------------|-----------|-----------|------------|-----------|------------|--------------------------|------------------|
| 175 | 28 | 8 | < 0,5 | > 12 | < 0,44 | > 65 | $1,8 + j0,7$ | $18 - j20$ |

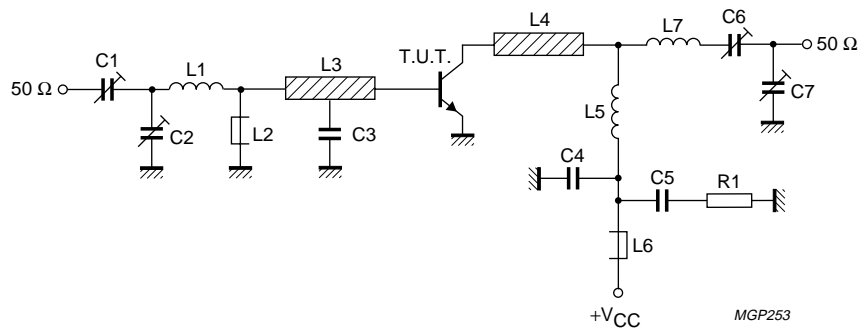

Fig.7 Test circuit; c.w. class-B.

List of components:

C1 = C7 = 2,5 to 20 pF film dielectric trimmer (cat. no. 2222 809 07004)

C2 = C6 = 5 to 60 pF film dielectric trimmer (cat. no. 2222 809 07011)

C3 = 27 pF ceramic capacitor (500 V)

C4 = 120 pF ceramic capacitor (500 V)

C5 = 100 nF polyester capacitor

L1 = 1 turn Cu wire (1,6 mm); int. dia. 8,4 mm; leads 2×5 mmL2 = 7 turns closely wound enamelled Cu wire (0,5 mm); int. dia. 3 mm; leads 2×5 mm

L3 = L8 = Ferroxcube wide band h.f. choke, grade 3B (cat. no. 4312 020 36640)

L4 = L5 = strip (12 mm \times 6 mm); tap for C3 at 5 mm from transistorL6 = 3 turns closely wound enamelled Cu wire (1,0 mm); int. dia. 9,0 mm; leads 2×5 mmL7 = 3 turns closely wound enamelled Cu wire (1,0 mm); int. dia. 8,2 mm; leads 2×5 mm

L4 and L5 are strips on a double Cu-clad printed-circuit board with epoxy fibre-glass dielectric, thickness 1/16".

R1 = R2 = 10 Ω carbon resistor

Component layout and printed-circuit board for 175 MHz test circuit see Fig.8.

VHF power transistor

BLV20

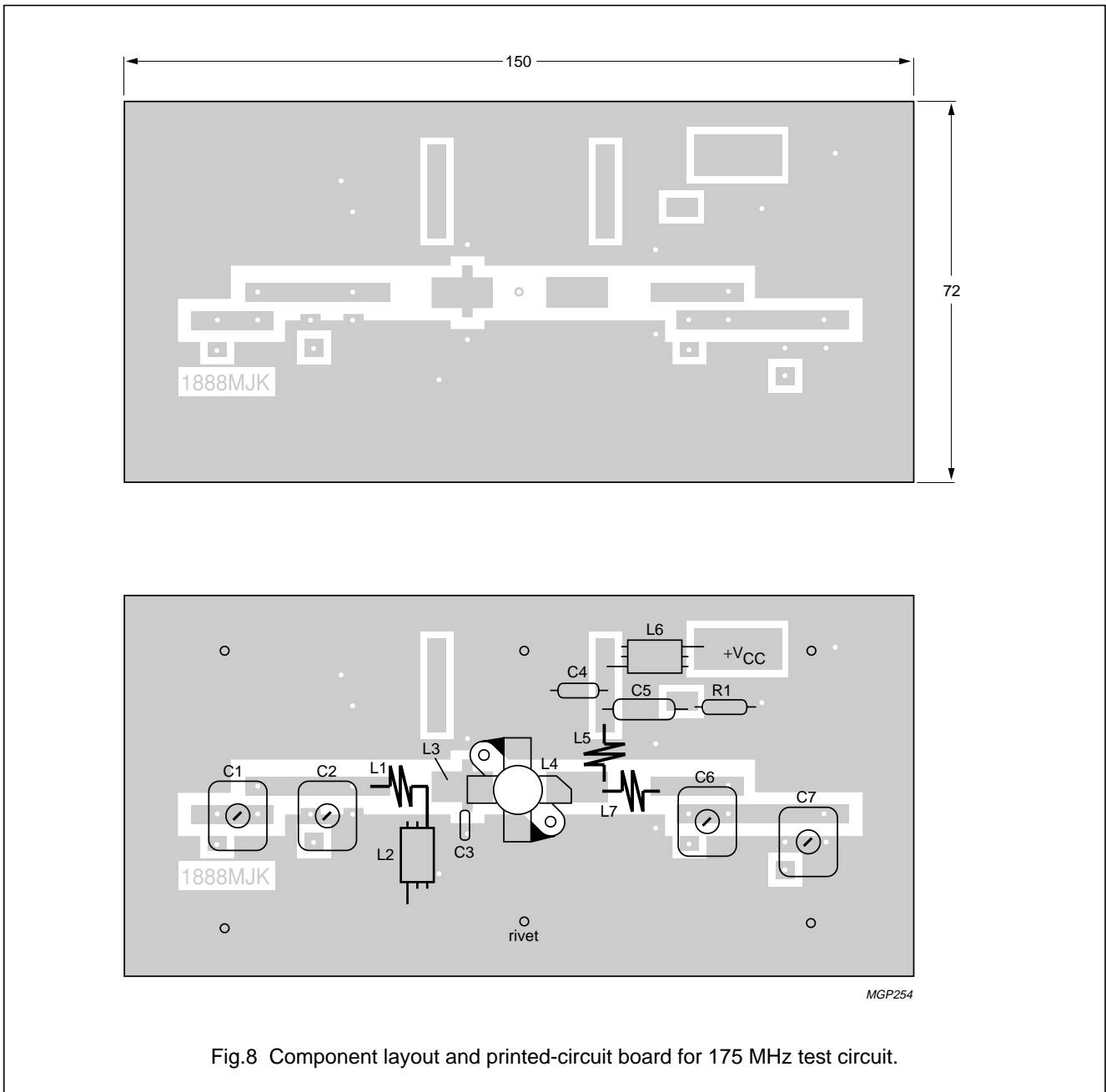

Fig.8 Component layout and printed-circuit board for 175 MHz test circuit.

The circuit and the components are situated on one side of the epoxy fibre-glass board, the other side being fully metallized to serve as earth. Earth connections are made by means of hollow rivets, whilst under the emitter leads Cu straps are used for a direct contact between upper and lower sheets.

VHF power transistor

BLV20

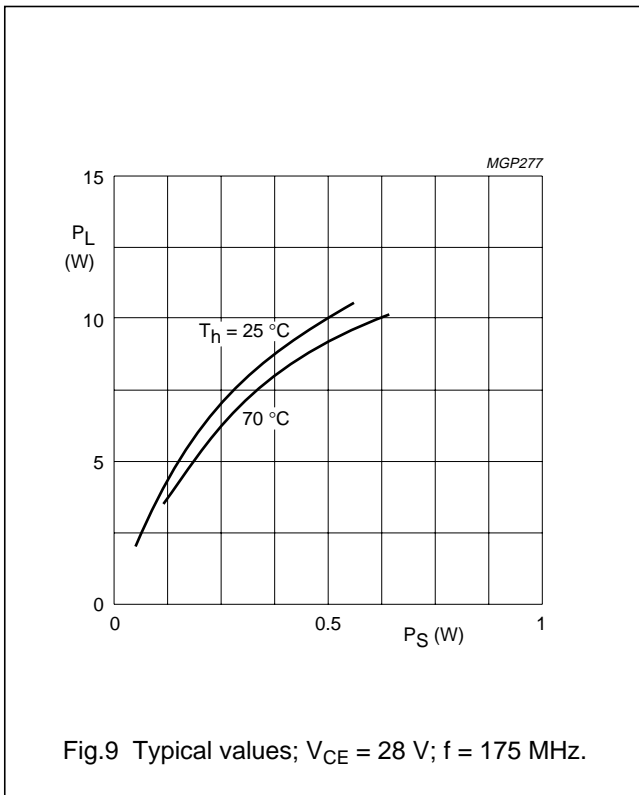

Fig.9 Typical values; $V_{CE} = 28$ V; $f = 175$ MHz.

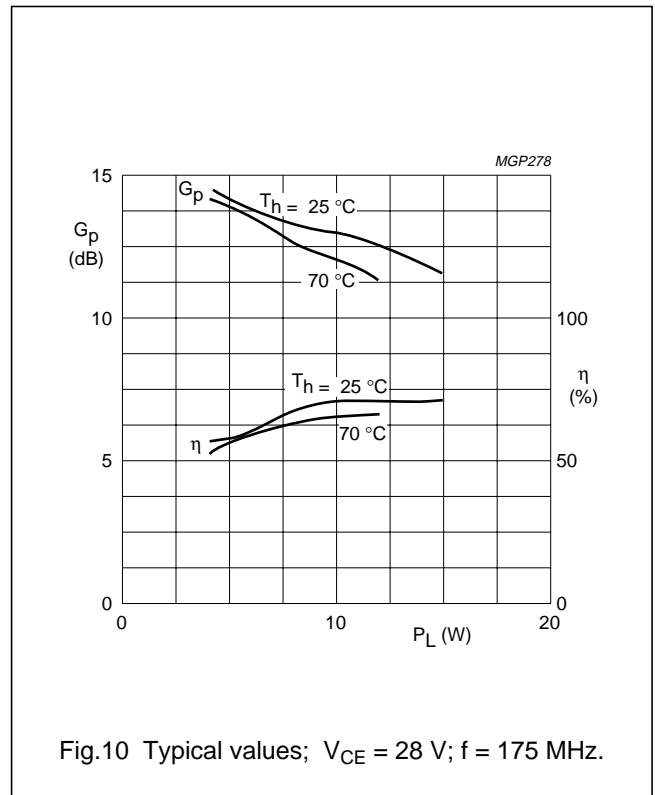
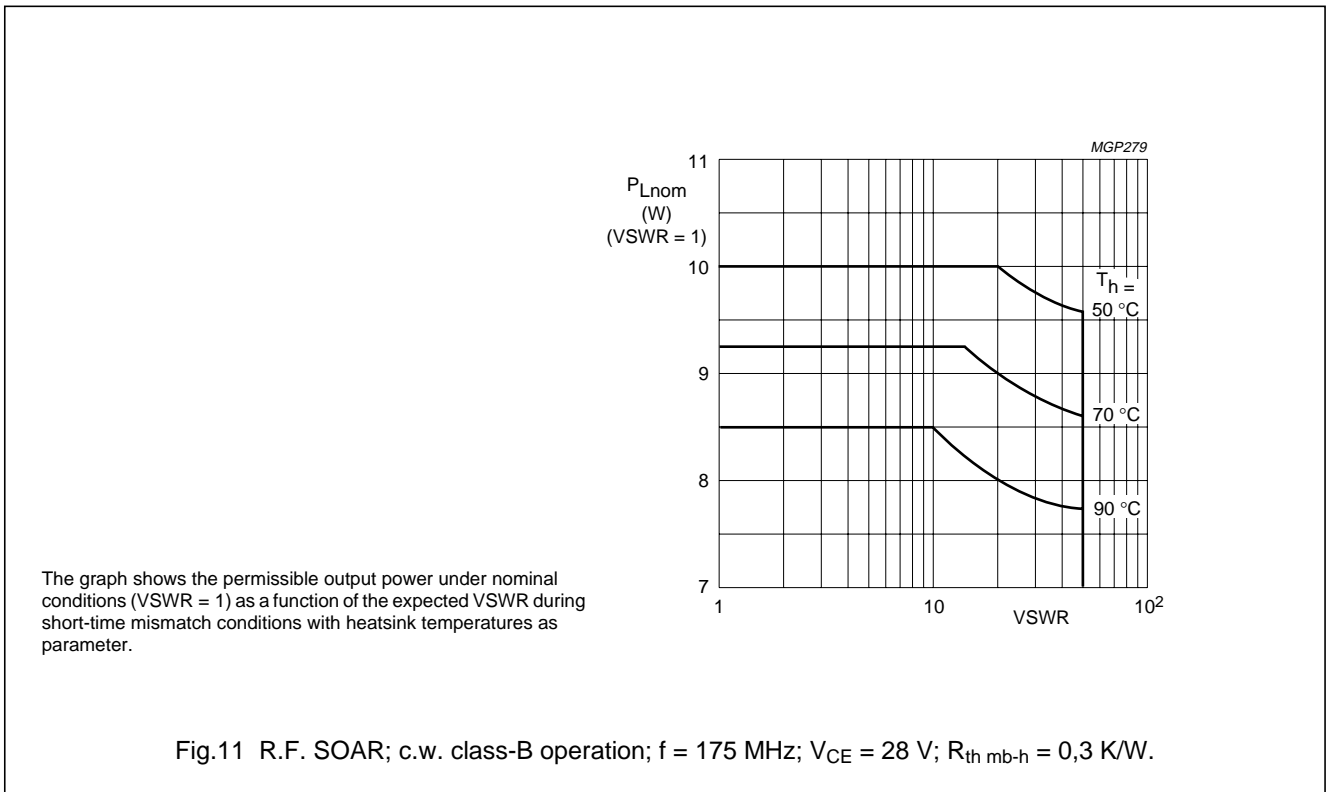

Fig.10 Typical values; $V_{CE} = 28$ V; $f = 175$ MHz.



The graph shows the permissible output power under nominal conditions ($V_{SWR} = 1$) as a function of the expected VSWR during short-time mismatch conditions with heatsink temperatures as parameter.

Fig.11 R.F. SOAR; c.w. class-B operation; $f = 175$ MHz; $V_{CE} = 28$ V; $R_{th\ mb-h} = 0,3$ K/W.

VHF power transistor

BLV20

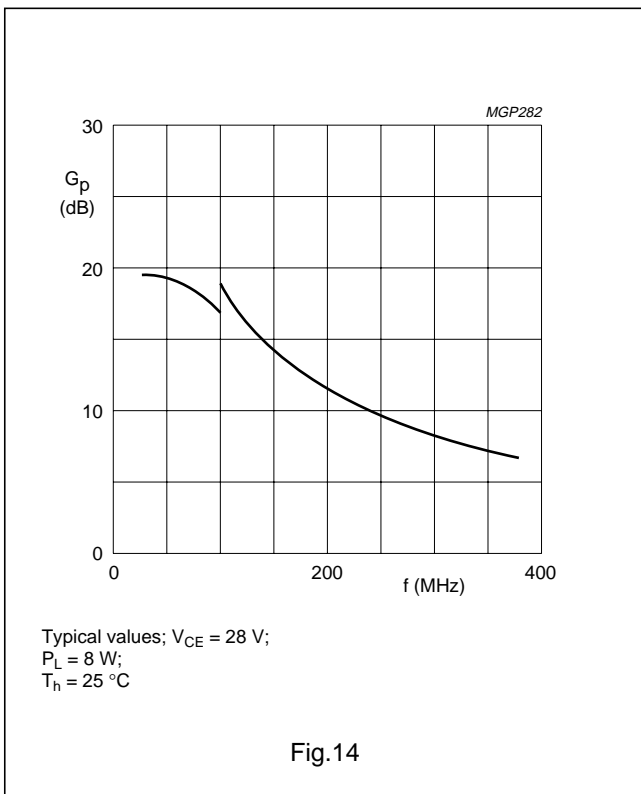
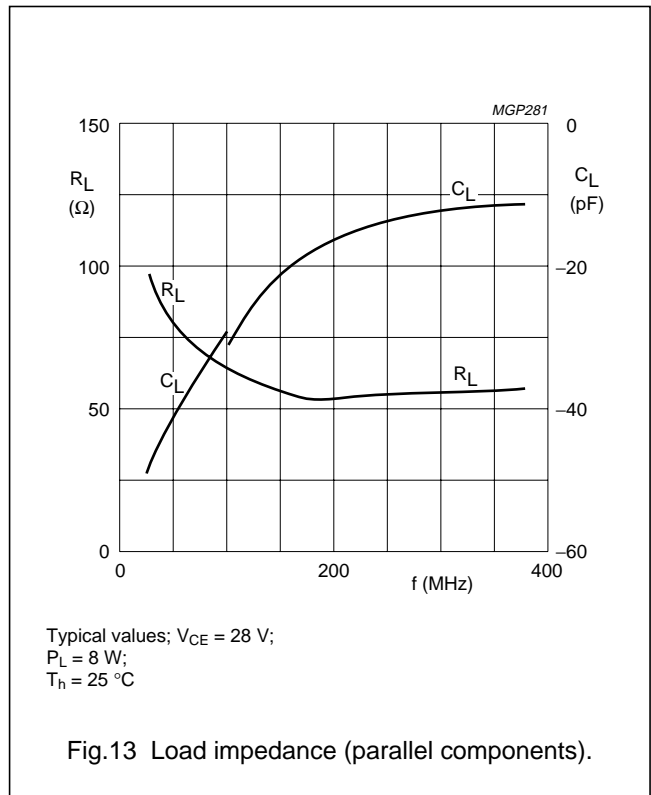
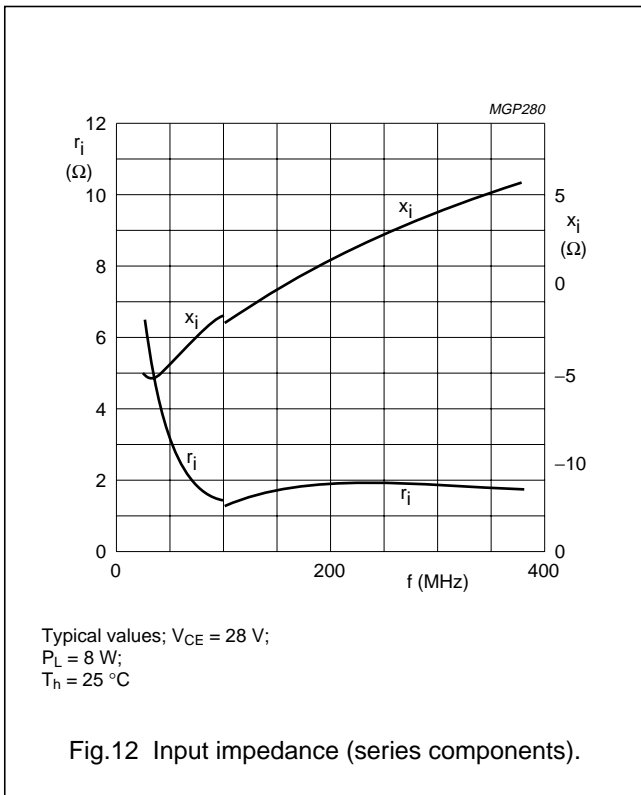

OPERATING NOTE

Below 100 MHz a base-emitter resistor of 10 Ω is recommended to avoid oscillation. This resistor must be effective for r.f. only.

VHF power transistor

BLV20

PACKAGE OUTLINE

Flanged ceramic package; 2 mounting holes; 4 leads

SOT123A

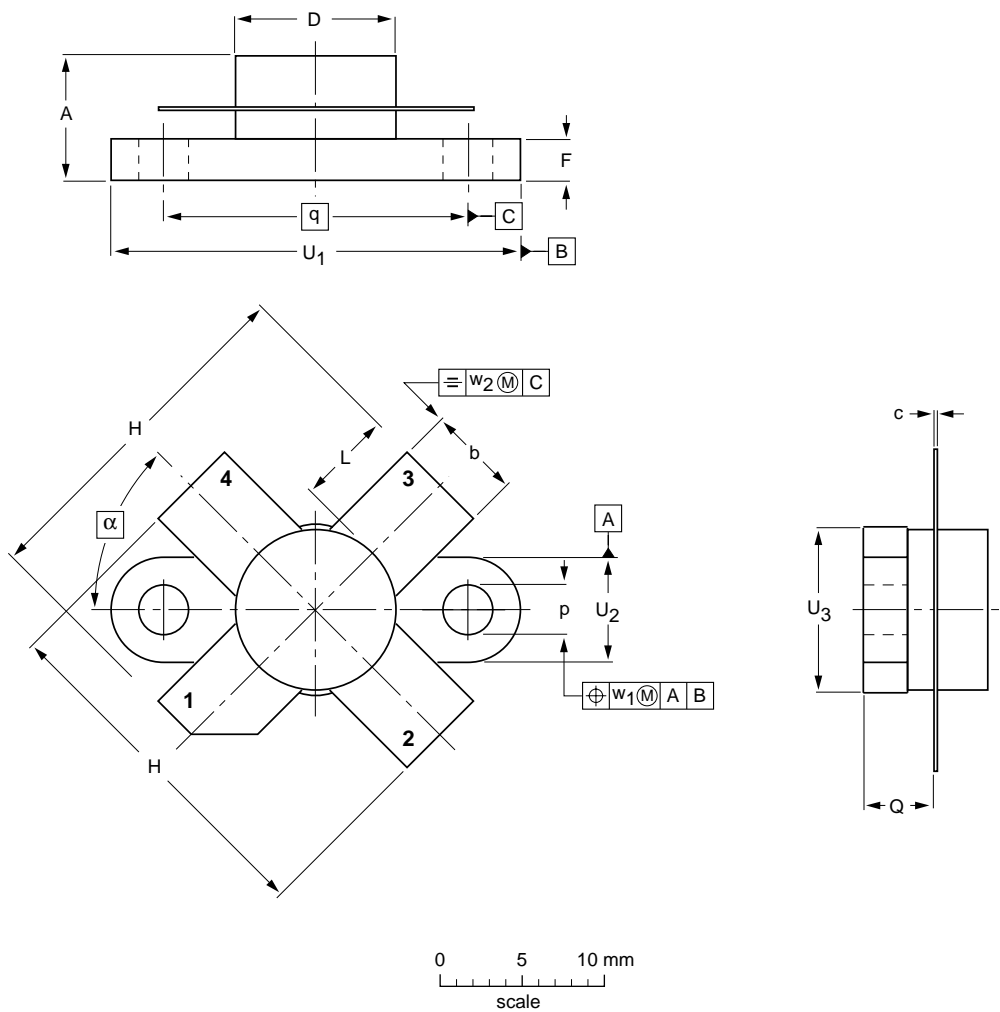

DIMENSIONS (millimetre dimensions are derived from the original inch dimensions)

| UNIT | A | b | c | D | D ₁ | F | H | L | p | Q | q | U ₁ | U ₂ | U ₃ | w ₁ | w ₂ | α |
|--------|----------------|----------------|----------------|----------------|----------------|----------------|----------------|----------------|----------------|----------------|-------|----------------|----------------|----------------|----------------|----------------|-----|
| mm | 7.47 6.37 | 5.82 5.56 | 0.18 0.10 | 9.73 9.47 | 9.63 9.42 | 2.72 2.31 | 20.71 19.93 | 5.61 5.16 | 3.33 3.04 | 4.63 4.11 | 18.42 | 25.15 24.38 | 6.61 6.09 | 9.78 9.39 | 0.51 | 1.02 | 45° |
| inches | 0.294 0.251 | 0.229 0.219 | 0.007 0.004 | 0.383 0.373 | 0.397 0.371 | 0.107 0.091 | 0.815 0.785 | 0.221 0.203 | 0.131 0.120 | 0.182 0.162 | 0.725 | 0.99 0.96 | 0.26 0.24 | 0.385 0.370 | 0.02 | 0.04 | |

| OUTLINE VERSION | REFERENCES | | | | EUROPEAN PROJECTION | ISSUE DATE |
|-----------------|------------|-------|------|--|---------------------|------------|
| | IEC | JEDEC | EIAJ | | | |
| SOT123A | | | | | | 97-06-28 |

VHF power transistor

BLV20

DEFINITIONS

| | |
|---|---|
| Data Sheet Status | |
| Objective specification | This data sheet contains target or goal specifications for product development. |
| Preliminary specification | This data sheet contains preliminary data; supplementary data may be published later. |
| Product specification | This data sheet contains final product specifications. |
| Limiting values | |
| Limiting values given are in accordance with the Absolute Maximum Rating System (IEC 134). Stress above one or more of the limiting values may cause permanent damage to the device. These are stress ratings only and operation of the device at these or at any other conditions above those given in the Characteristics sections of the specification is not implied. Exposure to limiting values for extended periods may affect device reliability. | |
| Application information | |
| Where application information is given, it is advisory and does not form part of the specification. | |

LIFE SUPPORT APPLICATIONS

These products are not designed for use in life support appliances, devices, or systems where malfunction of these products can reasonably be expected to result in personal injury. Philips customers using or selling these products for use in such applications do so at their own risk and agree to fully indemnify Philips for any damages resulting from such improper use or sale.