



DTC114E

NPN SILICON TRANSISTOR

NPN DIGITAL TRANSISTOR (BUILT-IN BIAS RESISTORS)

■ FEATURES

- * Built-in bias resistors that implies easy ON/OFF applications.
- * The bias resistors are thin-film resistors with complete isolation to allow negative input.

■ EQUIVALENT CIRCUIT

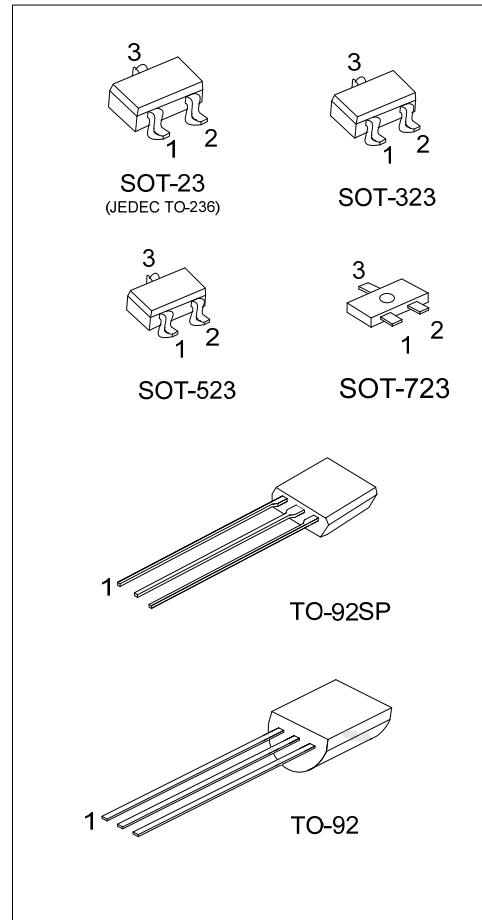
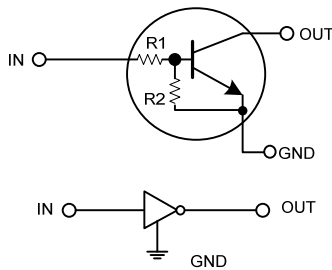

■ ORDERING INFORMATION

Ordering Number		Package	Pin Assignment			Packing
Lead Free	Halogen Free		1	2	3	
DTC114EL-AE3-R	DTC114EG-AE3-R	SOT-23	I	G	O	Tape Reel
DTC114EL-AL3-R	DTC114EG-AL3-R	SOT-323	I	G	O	Tape Reel
DTC114EL-AN3-R	DTC114EG-AN3-R	SOT-523	I	G	O	Tape Reel
DTC114EL-AQ3-R	DTC114EG-AQ3-R	SOT-723	I	G	O	Tape Reel
DTC114EL-T92-B	DTC114EG-T92-B	TO-92	G	O	I	Tape Box
DTC114EL-T92-K	DTC114EG-T92-K	TO-92	G	O	I	Bulk
DTC114EL-T9S-B	DTC114EG-T9S-B	TO-92SP	G	O	I	Tape Box
DTC114EL-T9S-K	DTC114EG-T9S-K	TO-92SP	G	O	I	Bulk

Note: Pin Assignment: I: IN G: GND O: OUT

<p>DTC114EG-AE3-R</p> <p>(1)Packing Type</p> <p>(2)Package Type</p> <p>(3)Green Package</p>	<p>(1) B: Tape Box, K: Bulk, R: Tape Reel</p> <p>(2) AE3: SOT-23, AL3: SOT-323, AN3: SOT-523 AQ3: SOT-723, T92: TO-92, T9S: TO-92SP</p> <p>(3) G: Halogen Free and Lead Free, L: Lead Free</p>
---	--

DTC114E

NPN SILICON TRANSISTOR

MARKING

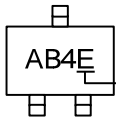
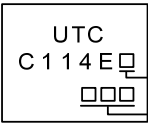
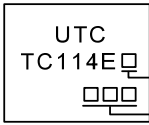
SOT-23 / SOT-323 SOT-523 / SOT-723	TO-92	TO-92SP
 <p>AB4E</p> <p>E: Lead Free E: Halogen Free</p>	 <p>UTC C 1 1 4 E</p> <p>L: Lead Free G: Halogen Free Date Code</p> <p>1</p>	 <p>UTC TC114E</p> <p>L: Lead Free G: Halogen Free Date Code</p> <p>1</p>

■ ABSOLUTE MAXIMUM RATINGS (T_A=25°C, unless others specified)

PARAMETER		SYMBOL	RATINGS	UNIT
Supply Voltage		V _{CC}	50	V
Input Voltage		V _{IN}	-10 ~ +40	V
Output Current		I _{OUT}	100	mA
Power Dissipation	SOT-23/SOT-323	P _D	200	mW
	SOT-523		150	
	SOT-723		100	
	TO-92		625	
	TO-92SP		550	
Junction Temperature		T _J	+150	°C
Storage Temperature		T _{STG}	-55 ~ +150	°C

Note: Absolute maximum ratings are those values beyond which the device could be permanently damaged. Absolute maximum ratings are stress ratings only and functional device operation is not implied.

■ ELECTRICAL CHARACTERISTICS (T_A=25°C, unless others specified)

PARAMETER	SYMBOL	TEST CONDITIONS	MIN	TYP	MAX	UNIT
Input Voltage	V _{IN(OFF)}	V _{CC} = 5V, I _{OUT} = 100μA			0.5	V
	V _{IN(ON)}	V _{OUT} = 0.3V, I _{OUT} = 10mA	3			V
Output Voltage	V _{OUT(ON)}	I _{OUT} /I _{IN} = 10mA/0.5mA		0.1	0.3	V
Input Current	I _{IN}	V _{IN} = 5V			0.88	mA
Output Current	I _{OUT(OFF)}	V _{CC} = 50V, V _{IN} = 0V			0.5	μA
DC Current Gain	h _{FE}	V _{OUT} = 5V, I _{OUT} = 5mA	30			
Input Resistance	R ₁		7	10	13	KΩ
Resistor Ratio	R ₂ /R ₁		0.8	1	1.2	
Transition Frequency	f _T	V _{CE} = 10V, I _E = -5mA, f = 100MHz (Note)		250		MHz

Note: Transition frequency of the device.

TYPICAL CHARACTERISTICS

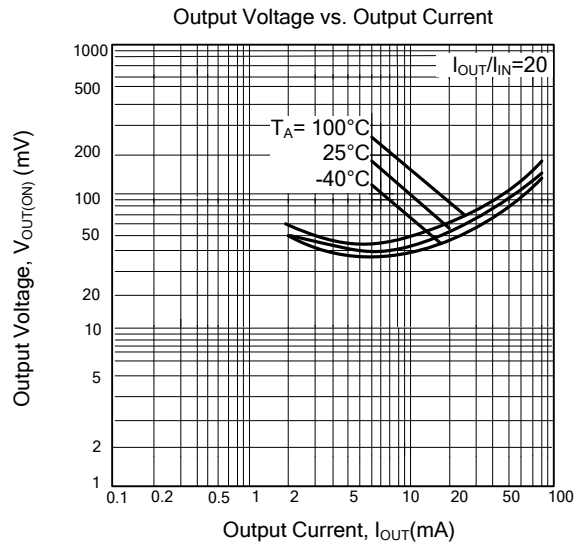
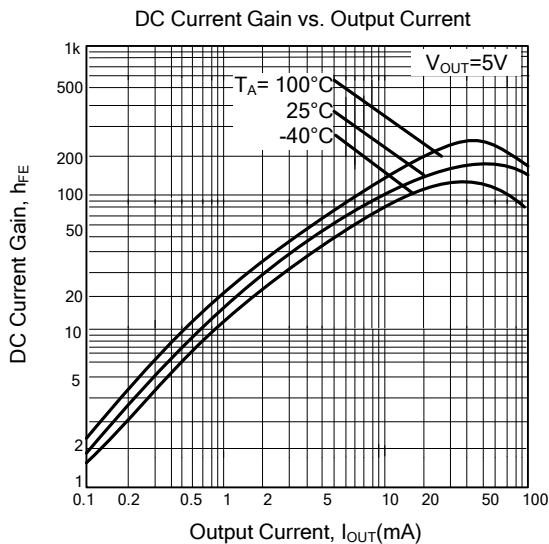
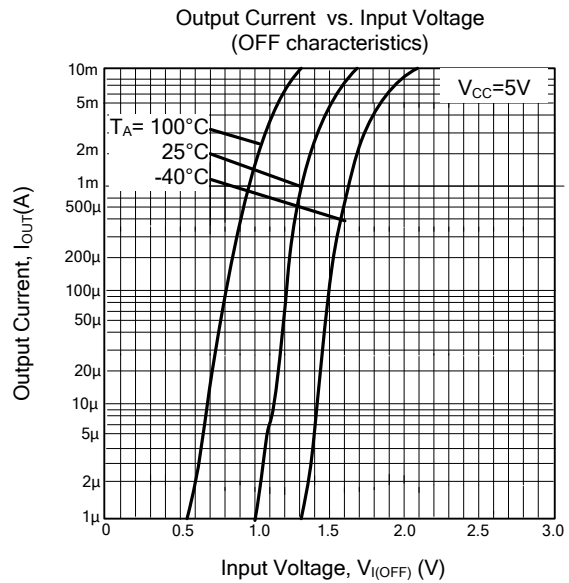
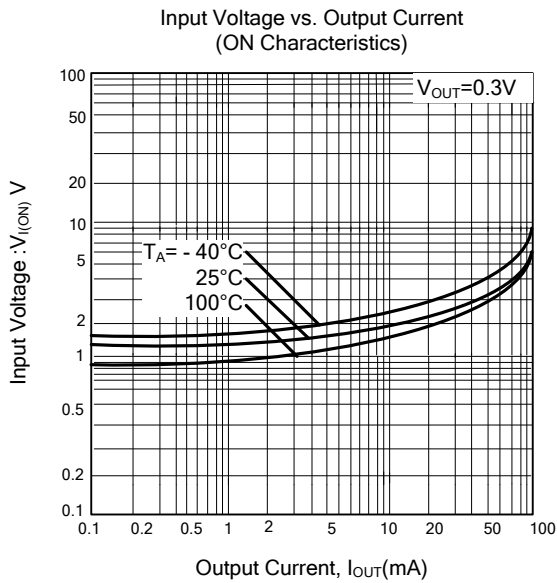

UTC assumes no responsibility for equipment failures that result from using products at values that exceed, even momentarily, rated values (such as maximum ratings, operating condition ranges, or other parameters) listed in products specifications of any and all UTC products described or contained herein. UTC products are not designed for use in life support appliances, devices or systems where malfunction of these products can be reasonably expected to result in personal injury. Reproduction in whole or in part is prohibited without the prior written consent of the copyright owner. UTC reserves the right to make changes to information published in this document, including without limitation specifications and product descriptions, at any time and without notice. This document supersedes and replaces all information supplied prior to the publication hereof.