

DATA SHEET

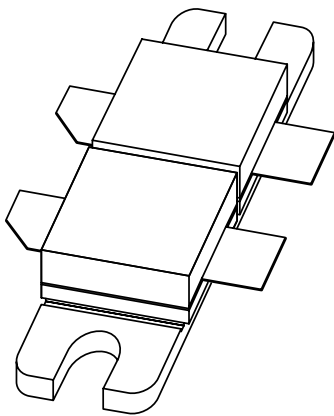

BLF368 VHF push-pull power MOS transistor

Product specification
Supersedes data of September 1992

1998 Jul 29

VHF push-pull power MOS transistor

BLF368

FEATURES

- High power gain
- Easy power control
- Good thermal stability
- Gold metallization ensures excellent reliability.

DESCRIPTION

Dual push-pull silicon N-channel enhancement mode vertical D-MOS transistor, designed for broadcast transmitter applications in the VHF frequency range.

The transistor is encapsulated in a 4-lead SOT262A1 balanced flange package, with two ceramic caps. The mounting flange provides the common source connection for the transistors.

PIN CONFIGURATION

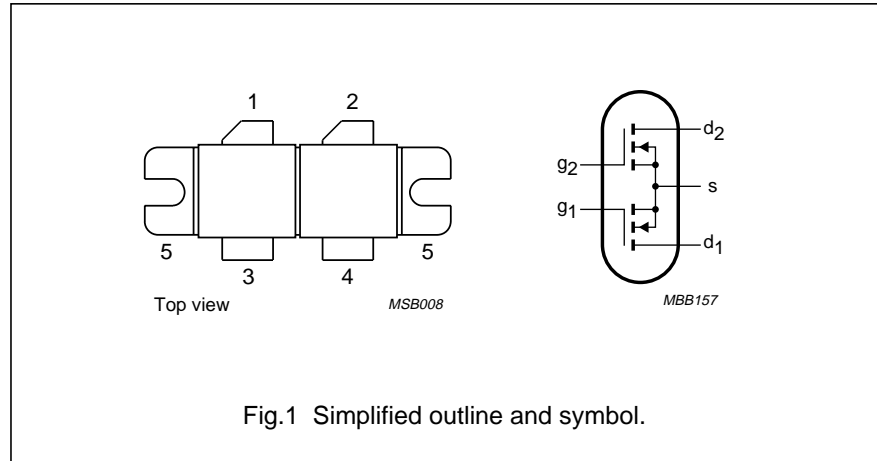

CAUTION

This product is supplied in anti-static packing to prevent damage caused by electrostatic discharge during transport and handling. For further information, refer to Philips specs.: SNW-EQ-608, SNW-FQ-302A, and SNW-FQ-302B.

PINNING - SOT262A1

PIN	DESCRIPTION
1	drain 1
2	drain 2
3	gate 1
4	gate 2
5	source

WARNING

Product and environmental safety - toxic materials

This product contains beryllium oxide. The product is entirely safe provided that the BeO discs are not damaged. All persons who handle, use or dispose of this product should be aware of its nature and of the necessary safety precautions. After use, dispose of as chemical or special waste according to the regulations applying at the location of the user. It must never be thrown out with the general or domestic waste.

QUICK REFERENCE DATA

RF performance at $T_h = 25\text{ }^\circ\text{C}$ in a push-pull common source test circuit.

MODE OF OPERATION	f (MHz)	V_{DS} (V)	P_L (W)	G_p (dB)	ΔG_p (dB) (note 1)	η_D (%)
CW, class-AB	225	32	300	>12 typ. 13.5	>1 typ. 0.4	>55 typ. 62

Note

1. Assuming a 3rd order amplitude transfer characteristic, 1 dB gain compression corresponds with 30% synchronized input/25% synchronized output compression in television service (negative modulation, CCIR system).

VHF push-pull power MOS transistor

BLF368

LIMITING VALUES

In accordance with the Absolute Maximum Rating System (IEC 134).

SYMBOL	PARAMETER	CONDITIONS	MIN.	MAX.	UNIT
Per transistor section unless otherwise specified					
V _{DSS}	drain-source voltage		–	65	V
V _{GSS}	gate-source voltage		–	±20	V
I _D	drain current (DC)		–	25	A
P _{tot}	total power dissipation	T _{mb} ≤ 25 °C total device; both sections equally loaded	–	500	W
T _{stg}	storage temperature		–65	150	°C
T _j	junction temperature		–	200	°C

THERMAL CHARACTERISTICS

SYMBOL	PARAMETER	CONDITIONS	VALUE	UNIT
R _{th j-mb}	thermal resistance from junction to mounting base	total device; both sections equally loaded	0.35	K/W
R _{th mb-h}	thermal resistance from mounting base to heatsink	total device; both sections equally loaded	0.15	K/W

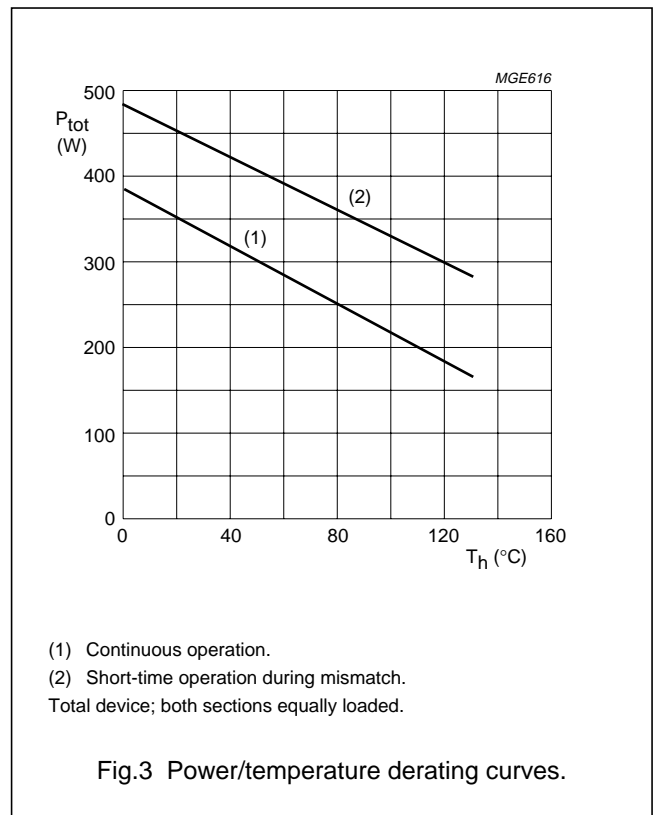
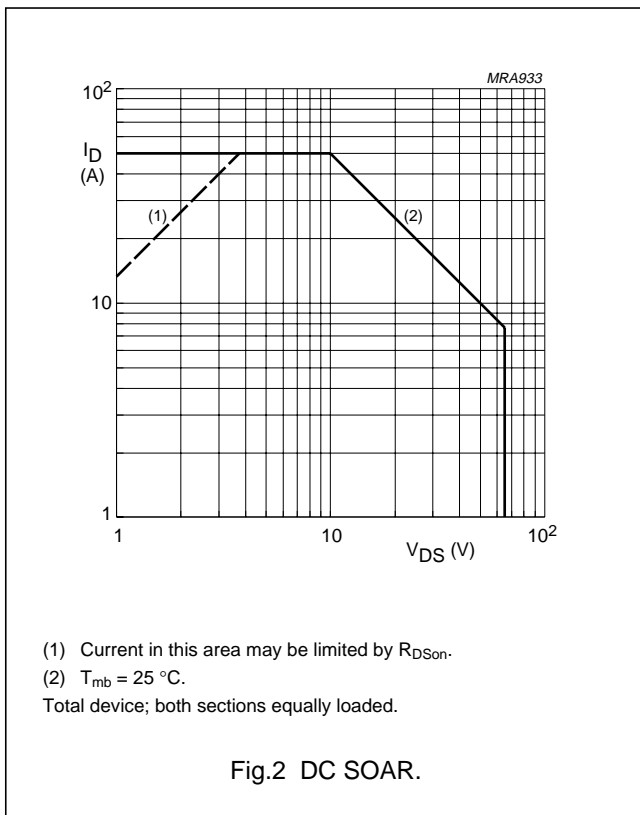

VHF push-pull power MOS transistor

BLF368

CHARACTERISTICS

$T_j = 25\text{ }^\circ\text{C}$ unless otherwise specified.

SYMBOL	PARAMETER	CONDITIONS	MIN.	TYP.	MAX.	UNIT
Per transistor section						
$V_{(BR)DSS}$	drain-source breakdown voltage	$V_{GS} = 0; I_D = 100\text{ mA}$	65	–	–	V
I_{DSS}	drain-source leakage current	$V_{GS} = 0; V_{DS} = 32\text{ V}$	–	–	5	mA
I_{GSS}	gate-source leakage current	$V_{GS} = \pm 20\text{ V}; V_{DS} = 0$	–	–	1	μA
V_{GSth}	gate-source threshold voltage	$I_D = 100\text{ mA}; V_{DS} = 10\text{ V}$	2	–	4.5	V
ΔV_{GS}	gate-source voltage difference of both transistor sections	$I_D = 100\text{ mA}; V_{DS} = 10\text{ V}$	–	–	100	mV
g_{fs}	forward transconductance	$I_D = 8\text{ A}; V_{DS} = 10\text{ V}$	5	7.5	–	S
g_{fs1}/g_{fs2}	forward transconductance ratio of both transistor sections	$I_D = 8\text{ A}; V_{DS} = 10\text{ V}$	0.9	–	1.1	
R_{DSon}	drain-source on-state resistance	$I_D = 8\text{ A}; V_{DS} = 10\text{ V}$	–	0.1	0.15	Ω
I_{DSX}	on-state drain current	$V_{GS} = 10\text{ V}; V_{DS} = 10\text{ V}$	–	37	–	A
C_{is}	input capacitance	$V_{GS} = 0; V_{DS} = 32\text{ V}; f = 1\text{ MHz}$	–	495	–	pF
C_{os}	output capacitance	$V_{GS} = 0; V_{DS} = 32\text{ V}; f = 1\text{ MHz}$	–	340	–	pF
C_{rs}	feedback capacitance	$V_{GS} = 0; V_{DS} = 32\text{ V}; f = 1\text{ MHz}$	–	40	–	pF
C_{d-f}	drain-flange capacitance		–	5.4	–	pF

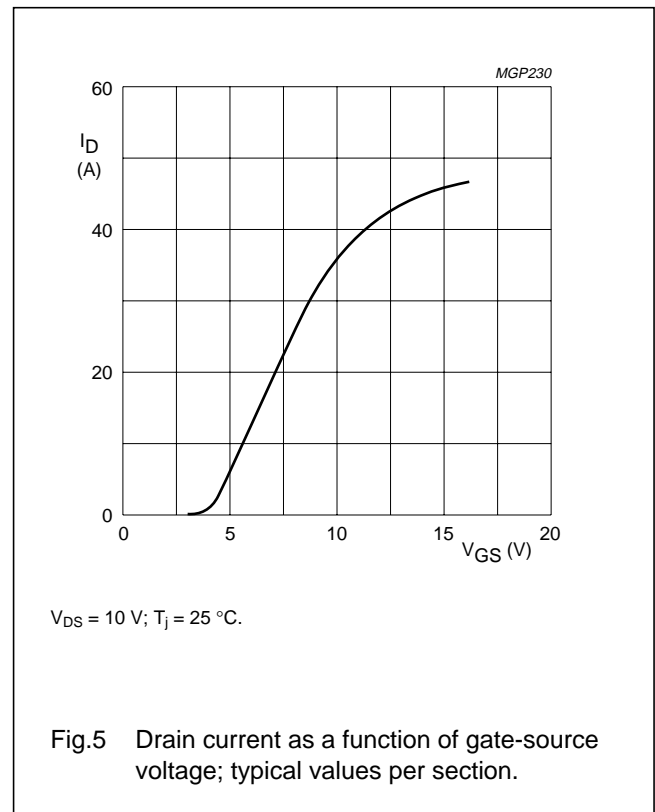
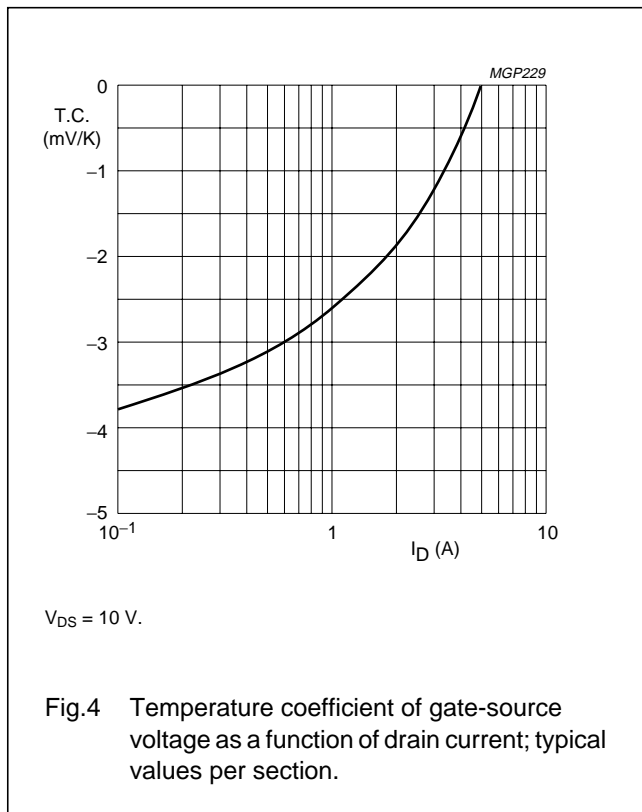

VHF push-pull power MOS transistor

BLF368

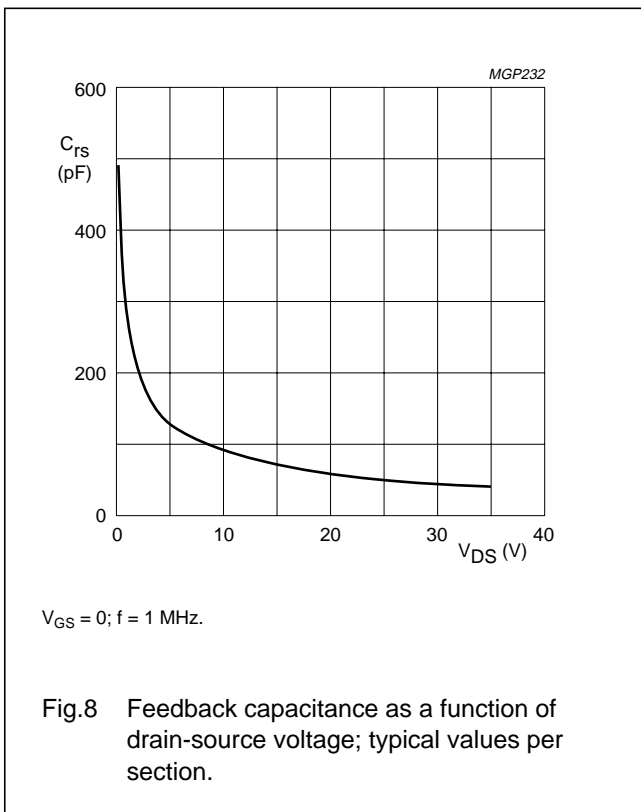
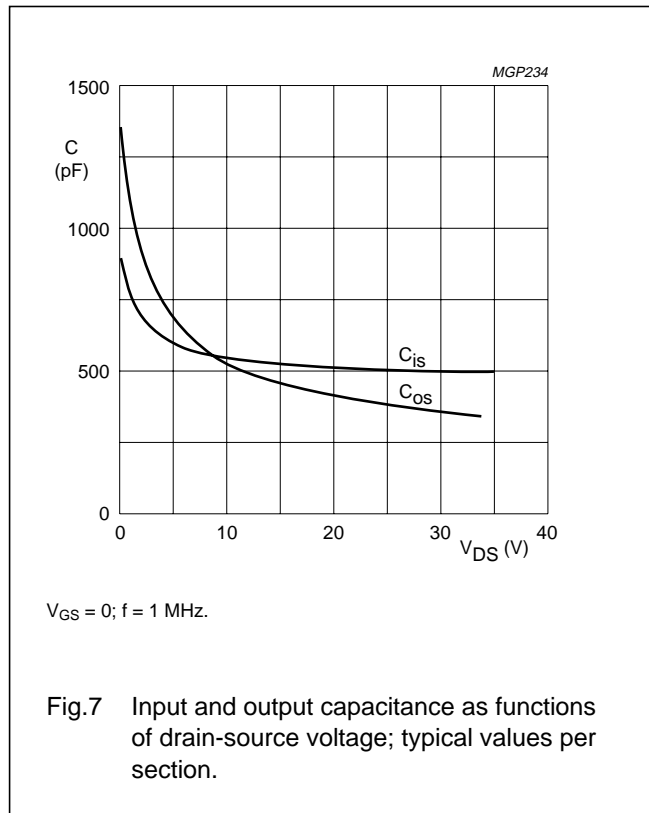
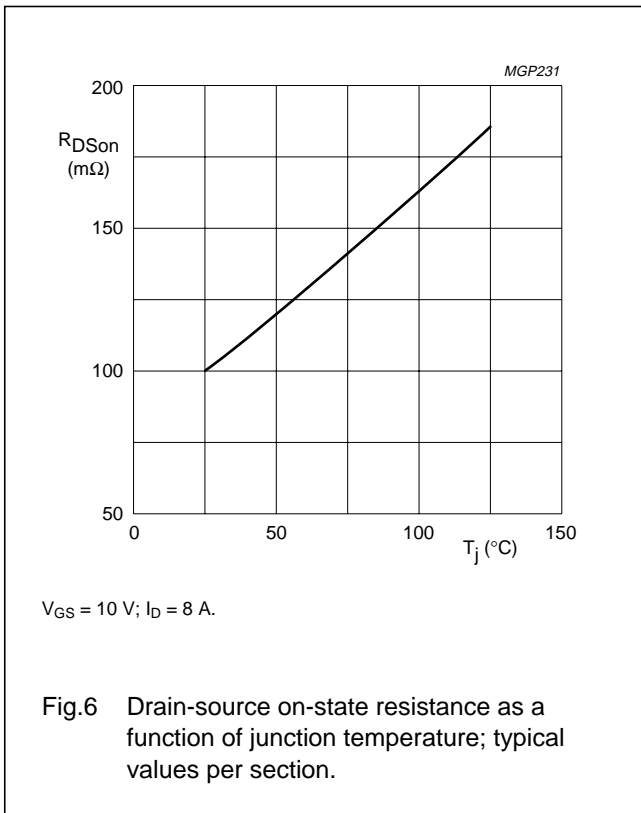

VHF push-pull power MOS transistor

BLF368

APPLICATION INFORMATION FOR CLASS-AB OPERATION

$T_h = 25\text{ }^\circ\text{C}$; $R_{th\text{ mb-h}} = 0.15\text{ K/W}$ unless otherwise specified. RF performance in CW operation in a common source class-AB circuit. $R_{GS} = 536\text{ }\Omega$ per section; optimum load impedance per section = $1.34 + j0.34\text{ }\Omega$; $V_{DS} = 32\text{ V}$.

MODE OF OPERATION	f (MHz)	V_{DS} (V)	I_{DQ} (mA)	P_L (W)	G_p (dB)	ΔG_p (dB) (note 1)	η_D (%)
CW, class-AB	225	32	2×250	300	>12 typ. 13.5	>1 typ. 0.4	>55 typ. 62
	225	28	2×250	300	typ. 13	typ. 0.7	typ. 68
	225	35	2×250	300	typ. 14	typ. 0.2	typ. 60
	175	28	2×250	300	typ. 15	typ. 0.5	typ. 70

Note

- Assuming a 3rd order amplitude transfer characteristic, 1 dB compression corresponds with 30% synchronized input/25% synchronized output compression in television service (negative modulation, CCIR system).

Ruggedness in class-AB operation

The BLF368 is capable of withstanding a load mismatch corresponding to $V_{SWR} = 10$ through all phases under the following conditions:

$V_{DS} = 32\text{ V}$; $f = 225\text{ MHz}$ at rated output power.

VHF push-pull power MOS transistor

BLF368

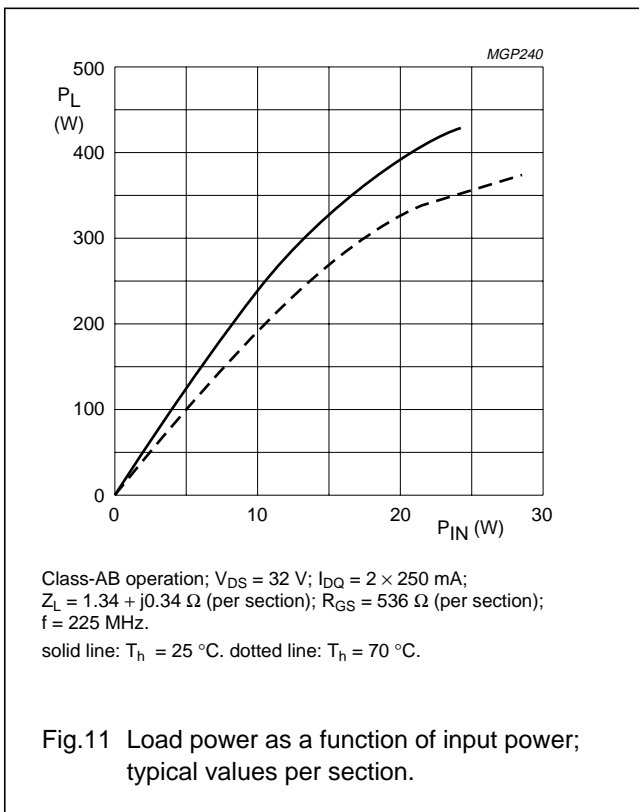
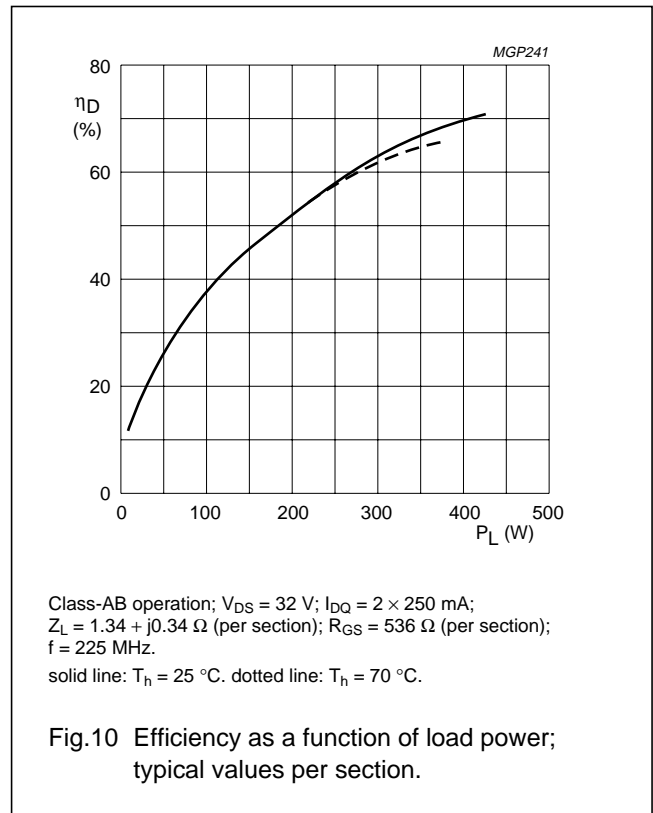
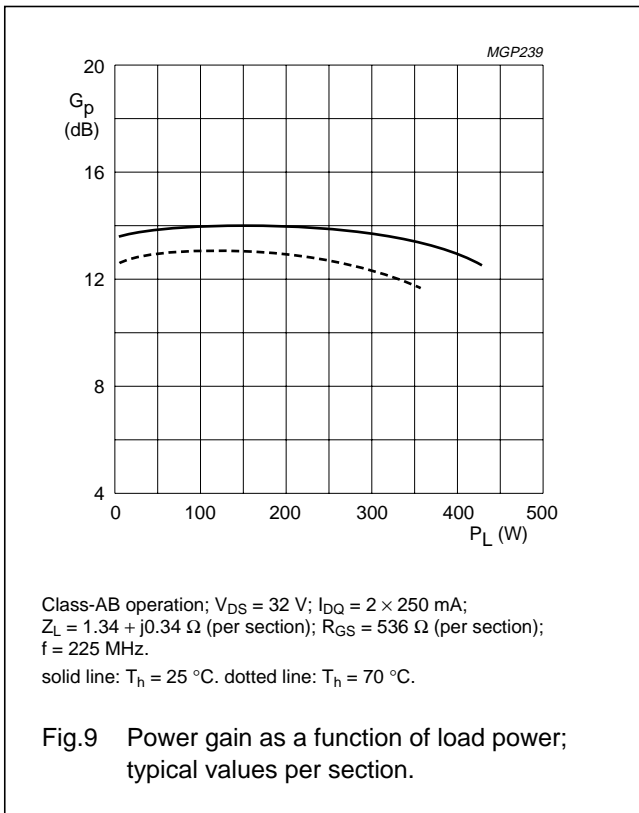

VHF push-pull power MOS transistor

BLF368

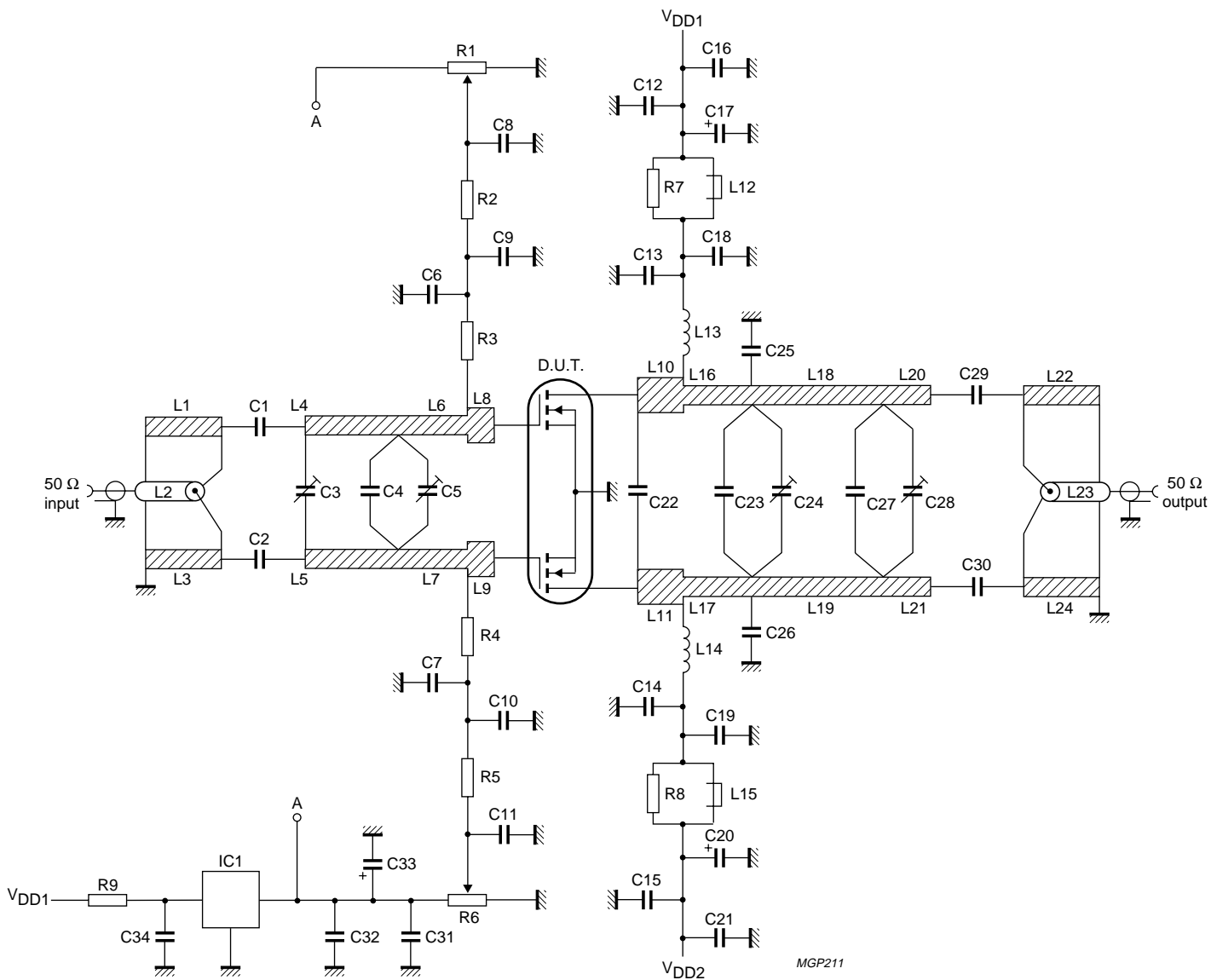

Fig.12 Test circuit for class-AB operation.

f = 225 MHz.

VHF push-pull power MOS transistor

BLF368

List of components class-AB test circuit (see Figs 12 and 13)

COMPONENT	DESCRIPTION	VALUE	DIMENSIONS	CATALOGUE No.
C1, C2	multilayer ceramic chip capacitor (note 1)	2 × 56 pF in parallel + 18 pF, 500 V		
C3	film dielectric trimmer	2 to 9 pF		2222 809 09005
C4	multilayer ceramic chip capacitor (note 1)	47 pF, 500 V		
C5	film dielectric trimmer	5 to 60 pF		2222 809 08003
C6, C7, C9, C10, C12, C15, C31, C34	multilayer ceramic chip capacitor (note 1)	1 nF, 500 V		2222 852 47104
C8, C11, C16, C21, C32	multilayer ceramic chip capacitor (note 1)	100 nF, 50 V		
C17, C20, C33	electrolytic capacitor	10 µF, 63 V		
C22	multilayer ceramic chip capacitor (note 1)	82 pF, 500 V		
C23	multilayer ceramic chip capacitor (note 1)	10 pF + 30 pF in parallel, 500 V		
C24, C28	film dielectric trimmer	2 to 18 pF		2222 809 09006
C25, C26	multilayer ceramic chip capacitor (note 1)	39 pF + 47 pF in parallel, 500 V		
C27	multilayer ceramic chip capacitor (note 1)	18 pF, 500 V		
C29, C30	multilayer ceramic chip capacitor (note 1)	3 × 100 pF in parallel, 500 V		
L1, L3, L22, L24	stripline (note 2)	50 Ω	4.8 × 80 mm	
L2, L23	semi-rigid cable (note 3)	50 Ω	ext. conductor length 80 mm ext. dia 3.6 mm	
L4, L5	stripline (note 2)	43 Ω	6 × 32.5 mm	
L6, L7	stripline (note 2)	43 Ω	6 × 10.5 mm	
L8, L9	stripline (note 2)	43 Ω	6 × 3 mm	
L10, L11	stripline (note 2)	43 Ω	6 × 10.5 mm	
L12, L15	grade 3B Ferroxcube wideband HF choke	2 in parallel		4312 020 36642
L13, L14	2 turns enamelled 1.6 mm copper wire	25 nH	space 2.5 mm int. dia. 5 mm leads 2 × 7 mm	
L16, L17	stripline (notes 2 and 4)	43 Ω	6 × 3 mm	
L18, L19	stripline (notes 2 and 4)	43 Ω	6 × 35 mm	
L20, L21	stripline (notes 2 and 4)	43 Ω	6 × 9 mm	
R1, R6	10 turns potentiometer	50 kΩ		
R2, R5	metal film resistor	0.4 W, 1 kΩ		
R3, R4	metal film resistor	0.4 W, 536 Ω		

VHF push-pull power MOS transistor

BLF368

COMPONENT	DESCRIPTION	VALUE	DIMENSIONS	CATALOGUE No.
R7, R8	metal film resistor	1 W, $\pm 5\%$, 10 Ω		
R9	metal film resistor	1 W, 3.16 k Ω		
IC1	voltage regulator 78L05			

Notes

1. American Technical Ceramics (ATC) capacitor, type 100B or other capacitor of the same quality.
2. The striplines L1, L3 - L11, L16 - L22 and L24 are on a double copper-clad printed circuit board with glass microfibre PTFE dielectric ($\epsilon_r = 2.2$); thickness $\frac{1}{16}$ inch; thickness of copper sheet $2 \times 35 \mu\text{m}$.
3. Semi-rigid cables L2 and L23 are soldered on to striplines L1 and L24.
4. A copper strap, thickness 0.8 mm, is soldered over the complete striplines L16 - L21 to avoid overheating by large RF currents.

VHF push-pull power MOS transistor

BLF368

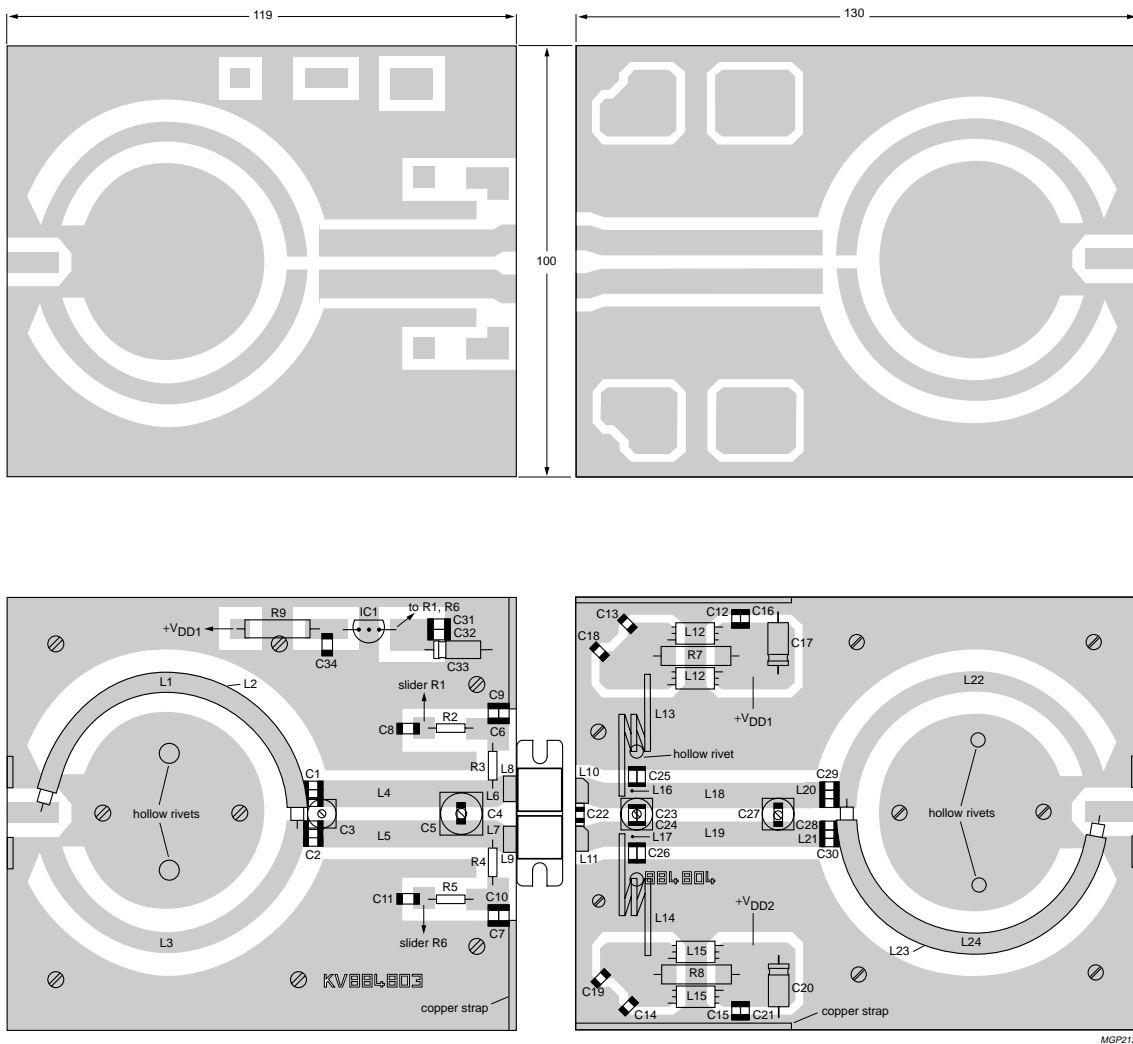

The circuit and components are situated on one side of the PTFE fibre-glass board, the other side being fully metallized, to serve as a ground plane. Earth connections are made by means of copper straps and hollow rivets for a direct contact between upper and lower sheets. Dimensions in mm.

Fig.13 Component layout for 225 MHz class-AB test circuit.

VHF push-pull power MOS transistor

BLF368

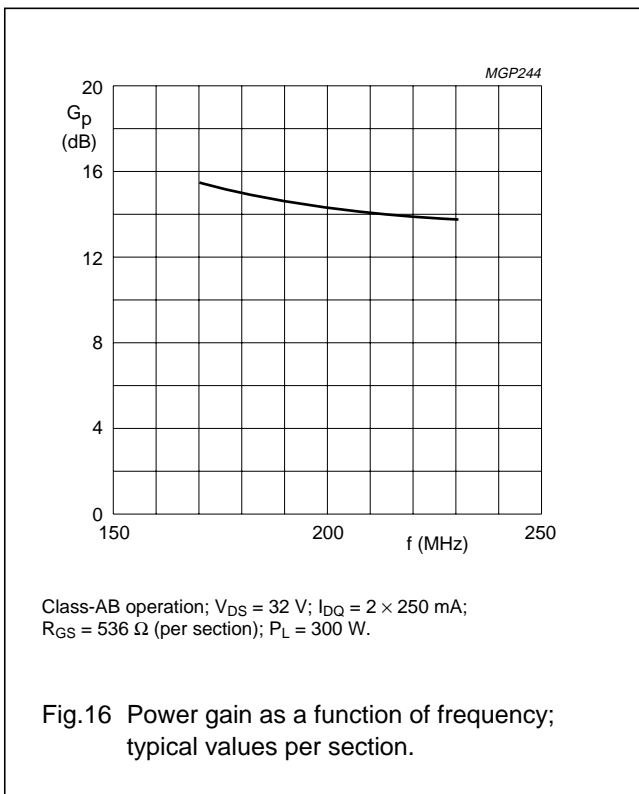
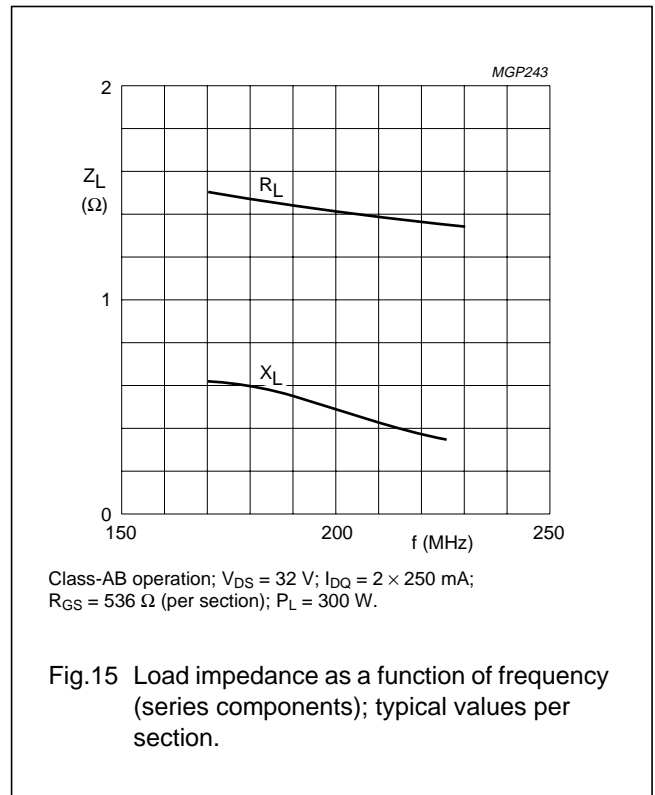
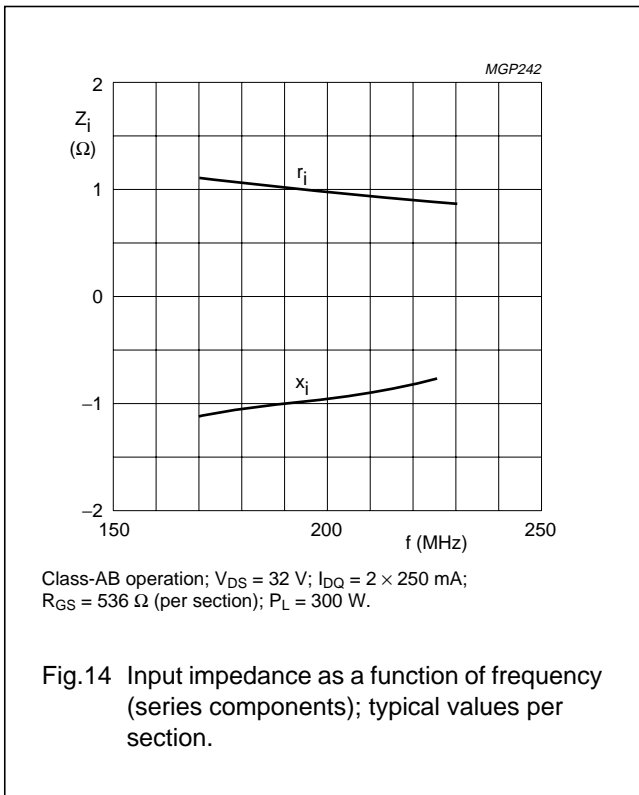

VHF push-pull power MOS transistor

BLF368

PACKAGE OUTLINE

Flanged double-ended ceramic package; 2 mounting holes; 4 leads

SOT262A1

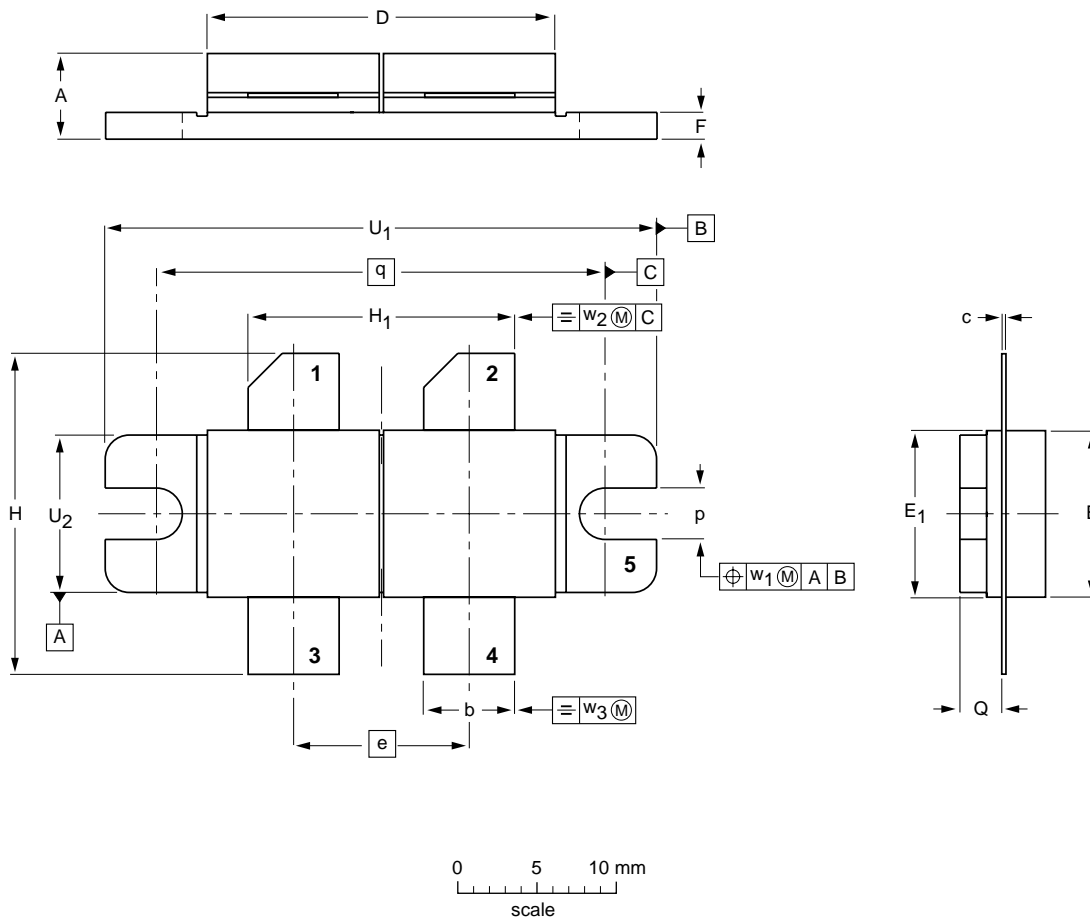

DIMENSIONS (millimetre dimensions are derived from the original inch dimensions)

UNIT	A	b	c	D	e	E	E ₁	F	H	H ₁	p	Q	q	U ₁	U ₂	w ₁	w ₂	w ₃
mm	5.77 5.00	5.85 5.58	0.16 0.10	21.98 21.71	11.05	10.27 10.05	10.29 10.03	1.78 1.52	20.58 20.06	17.02 16.51	3.28 3.02	2.85 2.59	27.94	34.17 33.90	9.91 9.65	0.51	1.02	0.25
inches	0.227 0.197	0.230 0.220	0.006 0.004	0.865 0.855	0.435	0.404 0.396	0.405 0.395	0.070 0.060	0.81 0.79	0.67 0.65	0.129 0.119	0.112 0.102	1.100	1.345 1.335	0.390 0.380	0.02	0.04	0.01

OUTLINE VERSION	REFERENCES				EUROPEAN PROJECTION	ISSUE DATE
	IEC	JEDEC	EIAJ			
SOT262A1						97-06-28

VHF push-pull power MOS transistor

BLF368

DEFINITIONS

Data Sheet Status	
Objective specification	This data sheet contains target or goal specifications for product development.
Preliminary specification	This data sheet contains preliminary data; supplementary data may be published later.
Product specification	This data sheet contains final product specifications.
Limiting values	
Limiting values given are in accordance with the Absolute Maximum Rating System (IEC 134). Stress above one or more of the limiting values may cause permanent damage to the device. These are stress ratings only and operation of the device at these or at any other conditions above those given in the Characteristics sections of the specification is not implied. Exposure to limiting values for extended periods may affect device reliability.	
Application information	
Where application information is given, it is advisory and does not form part of the specification.	

LIFE SUPPORT APPLICATIONS

These products are not designed for use in life support appliances, devices, or systems where malfunction of these products can reasonably be expected to result in personal injury. Philips customers using or selling these products for use in such applications do so at their own risk and agree to fully indemnify Philips for any damages resulting from such improper use or sale.

VHF push-pull power MOS transistor

BLF368

NOTES

Philips Semiconductors – a worldwide company

Argentina: see South America

Australia: 34 Waterloo Road, NORTH RYDE, NSW 2113, Tel. +61 2 9805 4455, Fax. +61 2 9805 4466

Austria: Computerstr. 6, A-1101 WIEN, P.O. Box 213, Tel. +43 160 1010, Fax. +43 160 101 1210

Belarus: Hotel Minsk Business Center, Bld. 3, r. 1211, Volodarski Str. 6, 220050 MINSK, Tel. +375 172 200 733, Fax. +375 172 200 773

Belgium: see The Netherlands

Brazil: see South America

Bulgaria: Philips Bulgaria Ltd., Energoproject, 15th floor, 51 James Bourchier Blvd., 1407 SOFIA, Tel. +359 2 689 211, Fax. +359 2 689 102

Canada: PHILIPS SEMICONDUCTORS/COMPONENTS, Tel. +1 800 234 7381

China/Hong Kong: 501 Hong Kong Industrial Technology Centre, 72 Tat Chee Avenue, Kowloon Tong, HONG KONG, Tel. +852 2319 7888, Fax. +852 2319 7700

Colombia: see South America

Czech Republic: see Austria

Denmark: Prags Boulevard 80, PB 1919, DK-2300 COPENHAGEN S, Tel. +45 32 88 2636, Fax. +45 31 57 0044

Finland: Sinikalliontie 3, FIN-02630 ESPOO, Tel. +358 9 615800, Fax. +358 9 61580920

France: 51 Rue Carnot, BP317, 92156 SURESNES Cedex, Tel. +33 1 40 99 6161, Fax. +33 1 40 99 6427

Germany: Hammerbrookstraße 69, D-20097 HAMBURG, Tel. +49 40 23 53 60, Fax. +49 40 23 536 300

Greece: No. 15, 25th March Street, GR 17778 TAVROS/ATHENS, Tel. +30 1 4894 339/239, Fax. +30 1 4814 240

Hungary: see Austria

India: Philips INDIA Ltd, Band Box Building, 2nd floor, 254-D, Dr. Annie Besant Road, Worli, MUMBAI 400 025, Tel. +91 22 493 8541, Fax. +91 22 493 0966

Indonesia: PT Philips Development Corporation, Semiconductors Division, Gedung Philips, Jl. Buncit Raya Kav.99-100, JAKARTA 12510, Tel. +62 21 794 0040 ext. 2501, Fax. +62 21 794 0080

Ireland: Newstead, Clonskeagh, DUBLIN 14, Tel. +353 1 7640 000, Fax. +353 1 7640 200

Israel: RAPAC Electronics, 7 Kehilat Saloniki St, PO Box 18053, TEL AVIV 61180, Tel. +972 3 645 0444, Fax. +972 3 649 1007

Italy: PHILIPS SEMICONDUCTORS, Piazza IV Novembre 3, 20124 MILANO, Tel. +39 2 6752 2531, Fax. +39 2 6752 2557

Japan: Philips Bldg 13-37, Kohnan 2-chome, Minato-ku, TOKYO 108-8507, Tel. +81 3 3740 5130, Fax. +81 3 3740 5077

Korea: Philips House, 260-199 Itaewon-dong, Yongsan-ku, SEOUL, Tel. +82 2 709 1412, Fax. +82 2 709 1415

Malaysia: No. 76 Jalan Universiti, 46200 PETALING JAYA, SELANGOR, Tel. +60 3 750 5214, Fax. +60 3 757 4880

Mexico: 5900 Gateway East, Suite 200, EL PASO, TEXAS 79905, Tel. +9-5 800 234 7381

Middle East: see Italy

Netherlands: Postbus 90050, 5600 PB EINDHOVEN, Bldg. VB, Tel. +31 40 27 82785, Fax. +31 40 27 88399

New Zealand: 2 Wagener Place, C.P.O. Box 1041, AUCKLAND, Tel. +64 9 849 4160, Fax. +64 9 849 7811

Norway: Box 1, Manglerud 0612, OSLO, Tel. +47 22 74 8000, Fax. +47 22 74 8341

Pakistan: see Singapore

Philippines: Philips Semiconductors Philippines Inc., 106 Valero St. Salcedo Village, P.O. Box 2108 MCC, MAKATI, Metro MANILA, Tel. +63 2 816 6380, Fax. +63 2 817 3474

Poland: Ul. Lukiska 10, PL 04-123 WARSZAWA, Tel. +48 22 612 2831, Fax. +48 22 612 2327

Portugal: see Spain

Romania: see Italy

Russia: Philips Russia, Ul. Usatcheva 35A, 119048 MOSCOW, Tel. +7 095 755 6918, Fax. +7 095 755 6919

Singapore: Lorong 1, Toa Payoh, SINGAPORE 319762, Tel. +65 350 2538, Fax. +65 251 6500

Slovakia: see Austria

Slovenia: see Italy

South Africa: S.A. PHILIPS Pty Ltd., 195-215 Main Road Martindale, 2092 JOHANNESBURG, P.O. Box 7430 Johannesburg 2000, Tel. +27 11 470 5911, Fax. +27 11 470 5494

South America: Al. Vicente Pinzon, 173, 6th floor, 04547-130 SÃO PAULO, SP, Brazil, Tel. +55 11 821 2333, Fax. +55 11 821 2382

Spain: Balmes 22, 08007 BARCELONA, Tel. +34 93 301 6312, Fax. +34 93 301 4107

Sweden: Kottbygatan 7, Akalla, S-16485 STOCKHOLM, Tel. +46 8 5985 2000, Fax. +46 8 5985 2745

Switzerland: Allmendstrasse 140, CH-8027 ZÜRICH, Tel. +41 1 488 2741 Fax. +41 1 488 3263

Taiwan: Philips Semiconductors, 6F, No. 96, Chien Kuo N. Rd., Sec. 1, TAIPEI, Taiwan Tel. +886 2 2134 2865, Fax. +886 2 2134 2874

Thailand: PHILIPS ELECTRONICS (THAILAND) Ltd., 209/2 Sanpavuth-Bangna Road Prakanong, BANGKOK 10260, Tel. +66 2 745 4090, Fax. +66 2 398 0793

Turkey: Talatpasa Cad. No. 5, 80640 GÜLTEPE/ISTANBUL, Tel. +90 212 279 2770, Fax. +90 212 282 6707

Ukraine: PHILIPS UKRAINE, 4 Patrice Lumumba str., Building B, Floor 7, 252042 KIEV, Tel. +380 44 264 2776, Fax. +380 44 268 0461

United Kingdom: Philips Semiconductors Ltd., 276 Bath Road, Hayes, MIDDLESEX UB3 5BX, Tel. +44 181 730 5000, Fax. +44 181 754 8421

United States: 811 East Arques Avenue, SUNNYVALE, CA 94088-3409, Tel. +1 800 234 7381

Uruguay: see South America

Vietnam: see Singapore

Yugoslavia: PHILIPS, Trg N. Pasica 5/v, 11000 BEOGRAD, Tel. +381 11 625 344, Fax. +381 11 635 777

For all other countries apply to: Philips Semiconductors, International Marketing & Sales Communications, Building BE-p, P.O. Box 218, 5600 MD EINDHOVEN, The Netherlands, Fax. +31 40 27 24825

Internet: <http://www.semiconductors.philips.com>

© Philips Electronics N.V. 1998

SCA60

All rights are reserved. Reproduction in whole or in part is prohibited without the prior written consent of the copyright owner.

The information presented in this document does not form part of any quotation or contract, is believed to be accurate and reliable and may be changed without notice. No liability will be accepted by the publisher for any consequence of its use. Publication thereof does not convey nor imply any license under patent- or other industrial or intellectual property rights.

Printed in The Netherlands

125108/00/03/pp16

Date of release: 1998 Jul 29

Document order number: 9397 750 04188

Let's make things better.

**Philips
Semiconductors**



PHILIPS