

# CAB016M12FM3, CAB016M12FM3T

1200 V, 16 mΩ, Silicon Carbide, Half-Bridge Module

$V_{DS}$	<b>1200 V</b>
$R_{DS(on)}$	<b>16 mΩ</b>

## Technical Features

- Ultra-Low Loss
- High Frequency Operation
- Zero Turn-Off Tail Current from MOSFET
- Normally-Off, Fail-Safe Device Operation
- Optional Pre-Applied Thermal Interface Material

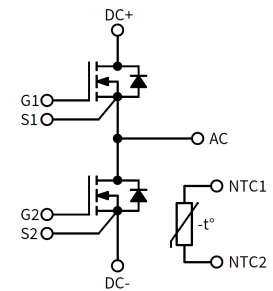

## Applications

- DC-DC Converters
- EV Chargers
- High-Efficiency Converters / Inverters
- Renewable Energy
- Smart-Grid / Grid-Tied Distributed Generation

## System Benefits

- Enables Compact, Lightweight Systems
- Increased System Efficiency, due to Low Switching & Conduction Losses of SiC
- Reduced Thermal Requirements and System Cost

## Maximum Parameters (Verified by Design)

Parameter	Symbol	Min.	Typ.	Max.	Unit	Test Conditions	Note
Drain-Source Voltage	$V_{DS}$			1200	V		
Gate-Source Voltage, Maximum Value	$V_{GS\ max}$	-8		+19		Transient, < 100 ns	Fig. 33
Gate-Source Voltage, Recommended	$V_{GS\ op}$	-4		+15		Static	
DC Continuous Drain Current ( $T_{VJ} \leq 150\ ^\circ\text{C}$ )	$I_D$		84		A	$V_{GS} = 15\ \text{V}, T_{HS} = 50\ ^\circ\text{C}, T_{VJ} \leq 150\ ^\circ\text{C}$	Fig. 20
DC Continuous Drain Current ( $T_{VJ} \leq 175\ ^\circ\text{C}$ )			89			$V_{GS} = 15\ \text{V}, T_{HS} = 50\ ^\circ\text{C}, T_{VJ} \leq 175\ ^\circ\text{C}$	
DC Source-Drain Current (Body Diode)	$I_{SD\ BD}$		55			$V_{GS} = -4\ \text{V}, T_{HS} = 50\ ^\circ\text{C}, T_{VJ} \leq 175\ ^\circ\text{C}$	
Pulsed Drain Current	$I_D\ (pulsed)$			178		$t_{pmax}$ limited by $T_{VJmax}$ $V_{GS} = 15\ \text{V}, T_{HS} = 50\ ^\circ\text{C}$	
Virtual Junction Temperature	$T_{VJ\ op}$	-40		150	$^\circ\text{C}$	Operation	
		-40		175		Intermittent with Reduced Life	



### MOSFET Characteristics (Per Position) ( $T_{VJ} = 25\text{ }^{\circ}\text{C}$ unless otherwise specified)

Parameter	Symbol	Min.	Typ.	Max.	Unit	Test Conditions	Note
Drain-Source Breakdown Voltage	$V_{(BR)DSS}$	1200				$V_{GS} = 0\text{ V}$ , $T_{VJ} = -40\text{ }^{\circ}\text{C}$	
Gate Threshold Voltage	$V_{GS(th)}$	1.8	2.5	3.6	V	$V_{DS} = V_{GS}$ , $I_D = 23\text{ mA}$	
			2.0			$V_{DS} = V_{GS}$ , $I_D = 23\text{ mA}$ , $T_{VJ} = 150\text{ }^{\circ}\text{C}$	
Zero Gate Voltage Drain Current	$I_{DSS}$		2	38	$\mu\text{A}$	$V_{GS} = 0\text{ V}$ , $V_{DS} = 1200\text{ V}$	
Gate-Source Leakage Current	$I_{GSS}$		0.02	0.5		$V_{GS} = 15\text{ V}$ , $V_{DS} = 0\text{ V}$	
Drain-Source On-State Resistance (Devices Only)	$R_{DS(on)}$		16.0	21.3	$\text{m}\Omega$	$V_{GS} = 15\text{ V}$ , $I_D = 80\text{ A}$	Fig. 2 Fig. 3
			25.6			$V_{GS} = 15\text{ V}$ , $I_D = 80\text{ A}$ , $T_{VJ} = 150\text{ }^{\circ}\text{C}$	
			28.8			$V_{GS} = 15\text{ V}$ , $I_D = 80\text{ A}$ , $T_{VJ} = 175\text{ }^{\circ}\text{C}$	
Transconductance	$g_{fs}$		52		S	$V_{DS} = 20\text{ V}$ , $I_D = 80\text{ A}$	Fig. 4
			49			$V_{DS} = 20\text{ V}$ , $I_D = 80\text{ A}$ , $T_{VJ} = 150\text{ }^{\circ}\text{C}$	
Turn-On Switching Energy, $T_{VJ} = 25\text{ }^{\circ}\text{C}$ $T_{VJ} = 125\text{ }^{\circ}\text{C}$ $T_{VJ} = 150\text{ }^{\circ}\text{C}$	$E_{On}$		1.00 1.13 1.17		mJ	$V_{DD} = 600\text{ V}$ , $I_D = 80\text{ A}$ , $V_{GS} = -4\text{ V}/15\text{ V}$ , $R_{G(OFF)} = 4.0\text{ }\Omega$ , $R_{G(ON)} = 4.0\text{ }\Omega$ , $L = 13.6\text{ }\mu\text{H}$	Fig. 11 Fig. 13
Turn-Off Switching Energy, $T_{VJ} = 25\text{ }^{\circ}\text{C}$ $T_{VJ} = 125\text{ }^{\circ}\text{C}$ $T_{VJ} = 150\text{ }^{\circ}\text{C}$	$E_{Off}$		0.54 0.54 0.52				
Internal Gate Resistance	$R_{G(int)}$		2.4		$\Omega$	$f = 100\text{ kHz}$ , $V_{AC} = 25\text{ mV}$	
Input Capacitance	$C_{iss}$		6.6		nF	$V_{GS} = 0\text{ V}$ , $V_{DS} = 800\text{ V}$ , $V_{AC} = 25\text{ mV}$ , $f = 100\text{ kHz}$	Fig. 9
Output Capacitance	$C_{oss}$		0.29				
Reverse Transfer Capacitance	$C_{rss}$		19		pF		
Gate to Source Charge	$Q_{GS}$		80		nC	$V_{DS} = 800\text{ V}$ , $V_{GS} = -4\text{ V}/15\text{ V}$ , $I_D = 80\text{ A}$ , Per IEC60747-8-4 pg 21	
Gate to Drain Charge	$Q_{GD}$		68				
Total Gate Charge	$Q_G$		236				
FET Thermal Resistance, Junction to Heatsink	$R_{th\ JHS}$		0.543		$^{\circ}\text{C}/\text{W}$	Measured with Pre-Applied TIM	Fig. 17

### Diode Characteristics (Per Position) ( $T_{VJ} = 25\text{ }^{\circ}\text{C}$ unless otherwise specified)

Parameter	Symbol	Min.	Typ.	Max.	Unit	Test Conditions	Notes
Body Diode Forward Voltage	$V_{SD}$		5.5		V	$V_{GS} = -4\text{ V}$ , $I_{SD} = 80\text{ A}$	Fig. 7
			4.9			$V_{GS} = -4\text{ V}$ , $I_{SD} = 80\text{ A}$ , $T_{VJ} = 150\text{ }^{\circ}\text{C}$	
Reverse Recovery Time	$t_{RR}$		20.0		ns	$V_{GS} = -4\text{ V}$ , $I_{SD} = 80\text{ A}$ , $V_R = 600\text{ V}$ , $di/dt = 10.4\text{ A/ns}$ , $T_{VJ} = 150\text{ }^{\circ}\text{C}$	Fig. 32
Reverse Recovery Charge	$Q_{RR}$		1.30		$\mu\text{C}$		
Peak Reverse Recovery Current	$I_{RRM}$		102		A		
Reverse Recovery Energy, $T_{VJ} = 25\text{ }^{\circ}\text{C}$ $T_{VJ} = 125\text{ }^{\circ}\text{C}$ $T_{VJ} = 150\text{ }^{\circ}\text{C}$	$E_{RR}$		0.08 0.32 0.41		mJ	$V_{DD} = 600\text{ V}$ , $I_D = 80\text{ A}$ , $V_{GS} = -4\text{ V}/15\text{ V}$ , $R_{G(ON)} = 4.0\text{ }\Omega$ , $L = 13.6\text{ }\mu\text{H}$	Fig. 14



## Module Physical Characteristics

Parameter	Symbol	Min.	Typ.	Max.	Unit	Test Conditions
Package Resistance, M1 (High-Side)	$R_{HS}$		2.23		m $\Omega$	$T_c = 125^\circ\text{C}$ , $I_D = 80\text{ A}$ , Note 1
Package Resistance, M2 (Low-Side)	$R_{LS}$		2.06			$T_c = 125^\circ\text{C}$ , $I_D = 80\text{ A}$ , Note 1
Stray Inductance	$L_{Stray}$		11.4		nH	Between DC- and DC+, $f = 10\text{ MHz}$
Case Temperature	$T_c$	-40		125	$^\circ\text{C}$	
Mounting Torque	$M_s$		2.0	2.3	N-m	M4 bolts
Weight	$W$		21		g	
Case Isolation Voltage	$V_{isol}$	3			kV	AC, 50 Hz, 1 minute
Comparative Tracking Index	CTI	200				
Clearance Distance			5.0		mm	Terminal to Terminal
			10.0			Terminal to Heatsink
Creepage Distance			6.3			Terminal to Terminal
			11.5			Terminal to Heatsink

Notes:

<sup>1</sup>Total Effective Resistance (Per Switch Position) = MOSFET  $R_{DS(on)}$  + Switch Position Package Resistance

## NTC Thermistor Characterization

Parameter	Symbol	Min.	Typ.	Max.	Unit	Test Conditions
Rated Resistance	$R_{NTC}$		5.0		k $\Omega$	$T_{NTC} = 25^\circ\text{C}$
Resistance Tolerance at 25 $^\circ\text{C}$	$\Delta R/R$	-5		5	%	
Beta Value ( $T_2 = 50^\circ\text{C}$ )	$\beta_{25/50}$		3380		K	
Beta Value ( $T_2 = 80^\circ\text{C}$ )	$\beta_{25/80}$		3468		K	
Beta Value ( $T_2 = 100^\circ\text{C}$ )	$\beta_{25/100}$		3523		K	
Power Dissipation	$P_{Max}$			10	mW	$T_{NTC} = 25^\circ\text{C}$



Typical Performance

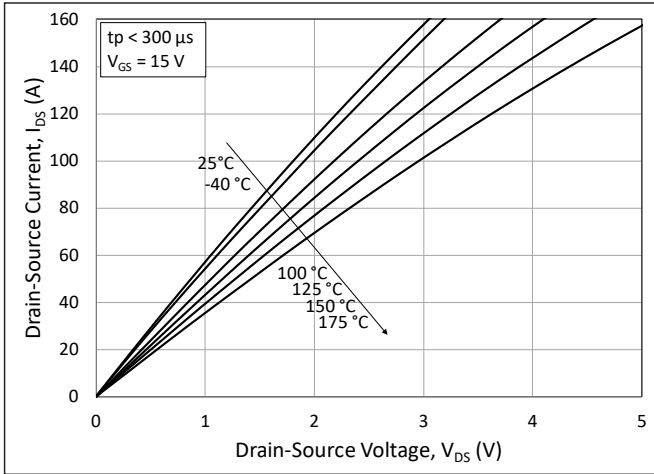

Figure 1. Output Characteristics for Various Junction Temperatures

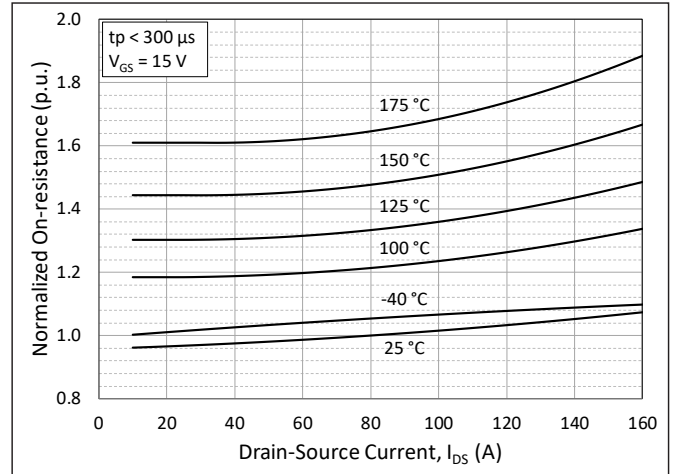

Figure 2. Normalized On-State Resistance vs. Drain Current for Various Junction Temperatures

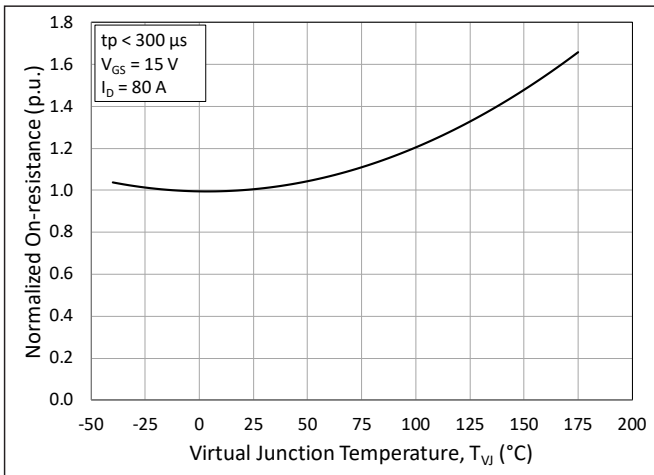

Figure 3. Normalized On-State Resistance vs. Junction Temperature

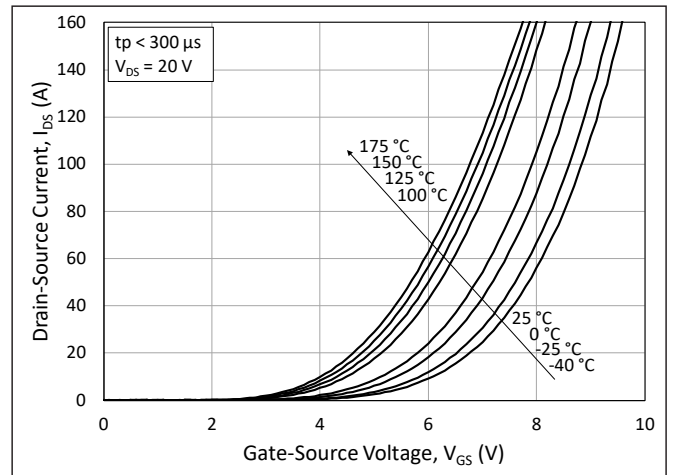

Figure 4. Transfer Characteristic for Various Junction Temperatures

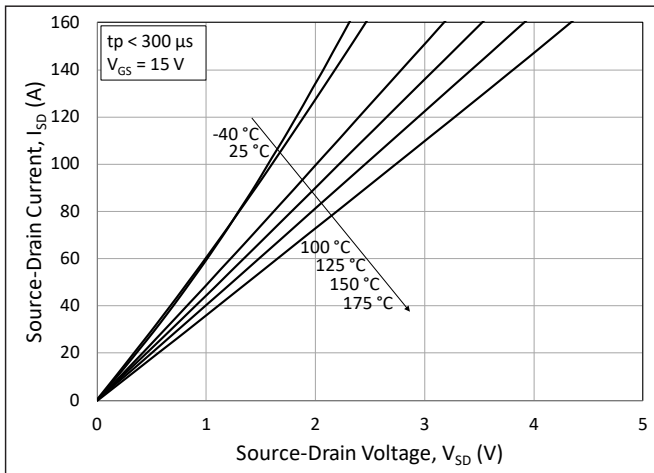

Figure 5. 3<sup>rd</sup> Quadrant Characteristic vs. Junction Temperatures at  $V_{GS} = 15\text{ V}$

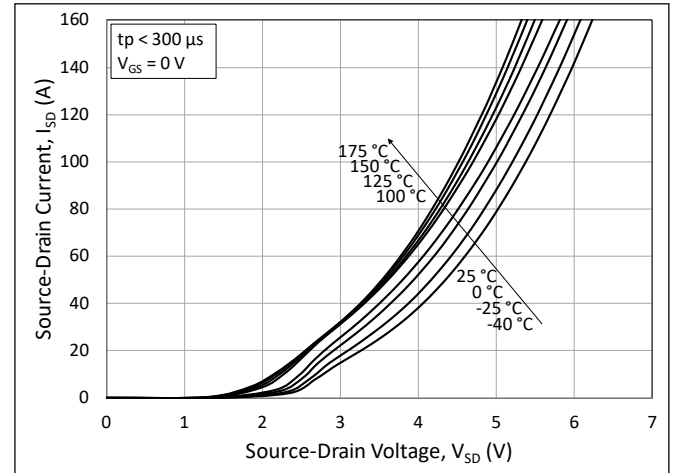

Figure 6. 3<sup>rd</sup> Quadrant Characteristic vs. Junction Temperatures at  $V_{GS} = 0\text{ V}$



Typical Performance

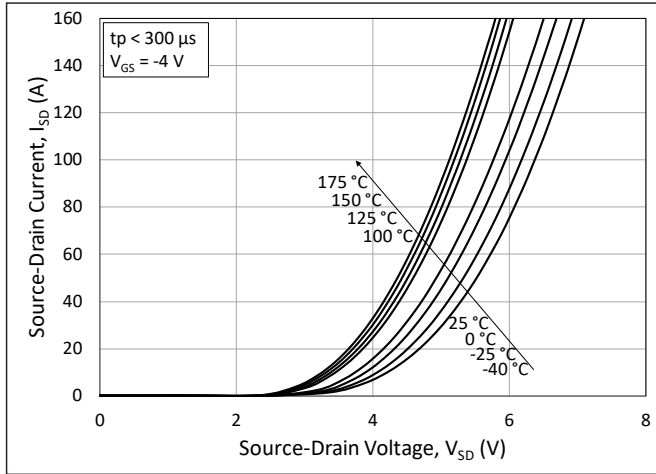

Figure 7. 3<sup>rd</sup> Quadrant Characteristic vs. Junction Temperatures at  $V_{GS} = -4$  V (Body Diode)

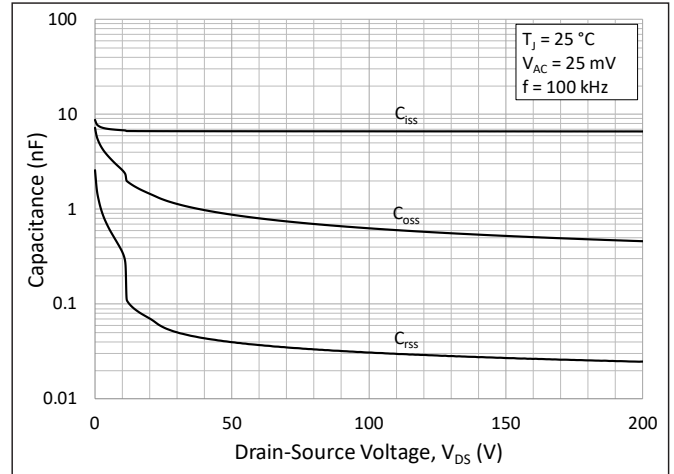

Figure 8. Typical Capacitances vs. Drain to Source Voltage (0 - 200 V)

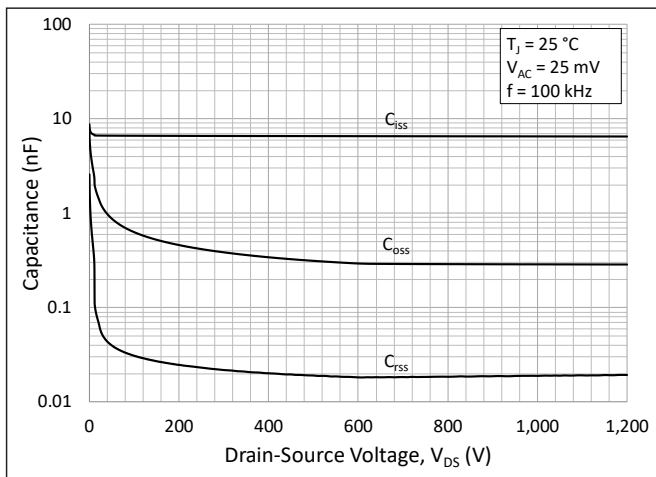

Figure 9. Typical Capacitances vs. Drain to Source Voltage (0 - 1200 V)

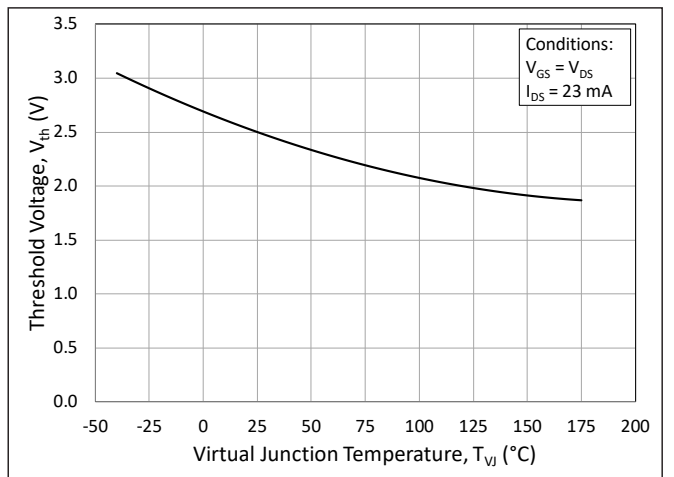

Figure 10. Threshold Voltage vs. Junction Temperature

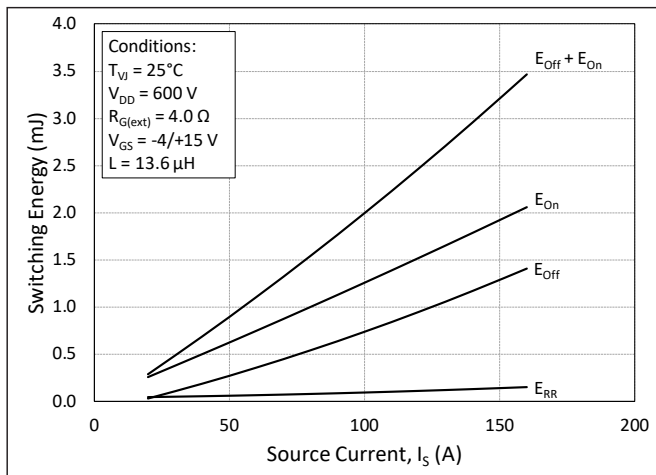

Figure 11. Switching Energy vs. Drain Current ( $V_{DD} = 600$  V)

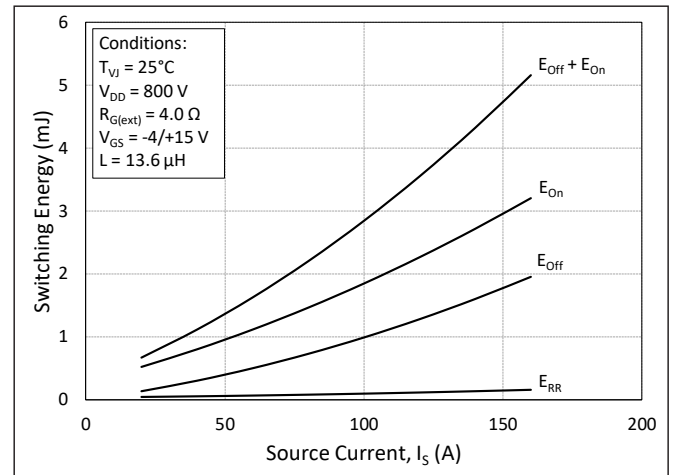

Figure 12. Switching Energy vs. Drain Current ( $V_{DD} = 800$  V)

Typical Performance

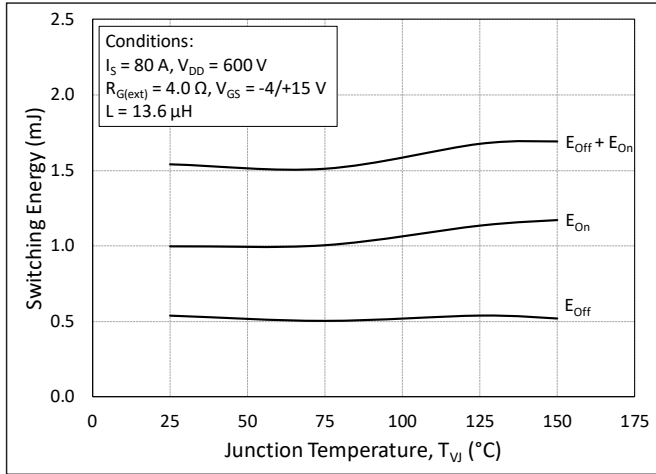

Figure 13. MOSFET Switching Energy vs. Junction Temperature

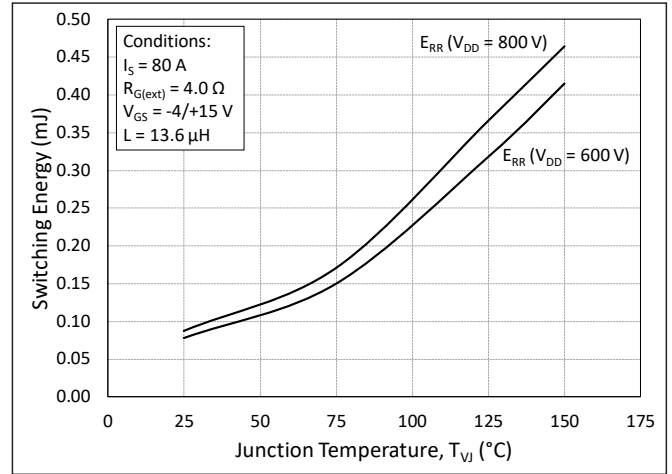

Figure 14. Reverse Recovery Energy vs. Junction Temperature

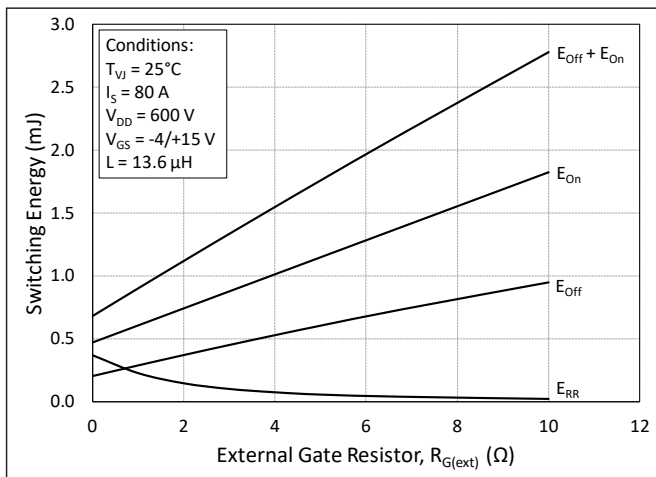

Figure 15. MOSFET Switching Energy vs. External Gate Resistance

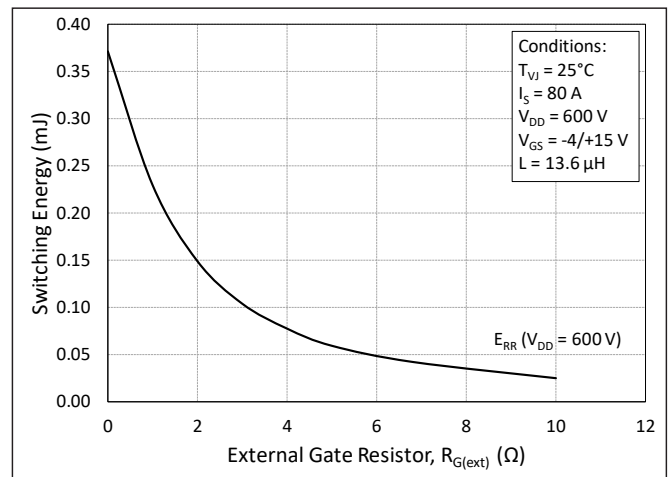

Figure 16. Reverse Recovery Energy vs. External Gate Resistance

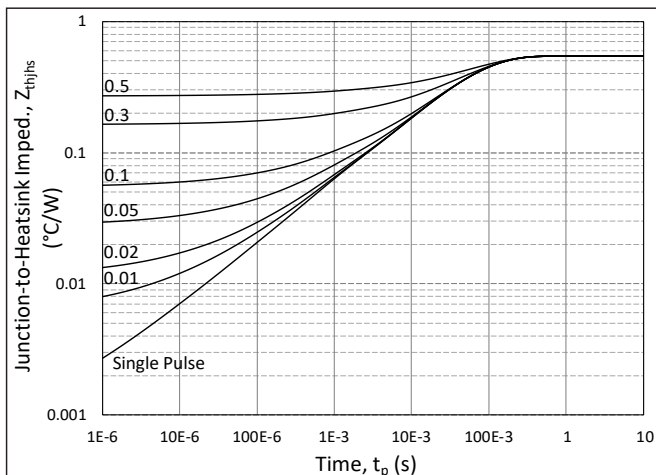

Figure 17. MOSFET Junction to Heatsink Transient Thermal Impedance,  $Z_{thjhs}$  (°C/W)

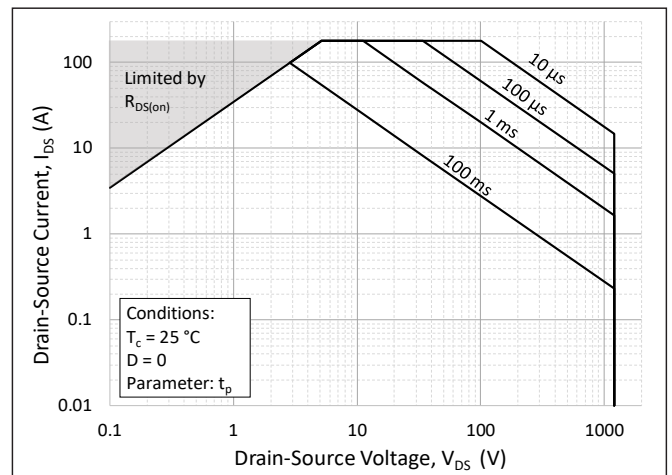

Figure 18. Forward Bias Safe Operating Area (FBSOA)

### Typical Performance

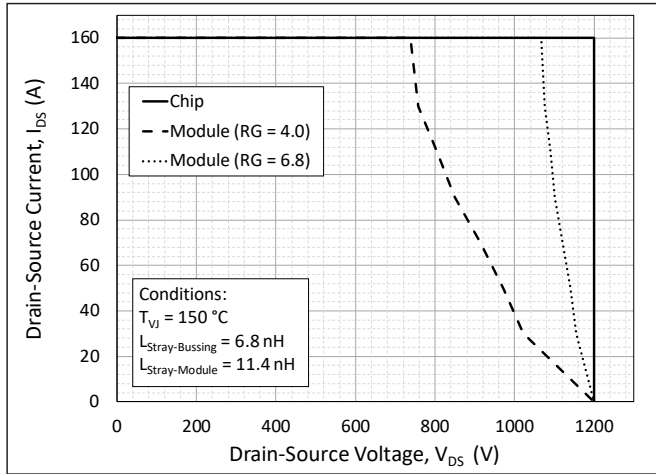

Figure 19. Switching Safe Operating Area

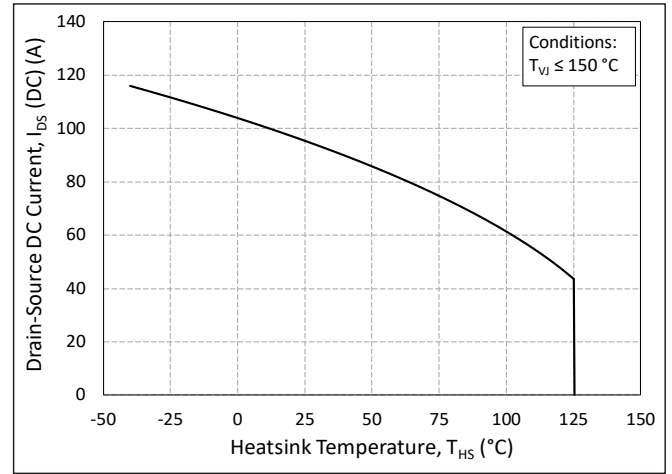

Figure 20. Continuous Drain Current Derating vs. Heatsink Temperature

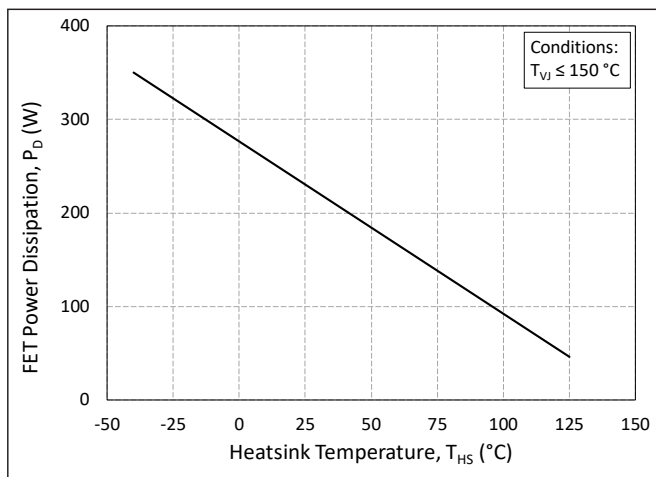

Figure 21. Maximum Power Dissipation Derating vs. Heatsink Temperature

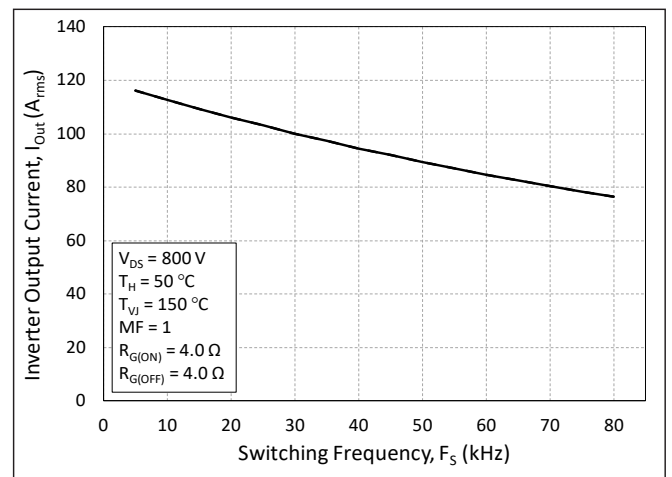

Figure 22. Typical Output Current Capability vs. Switching Frequency (Inverter Application)

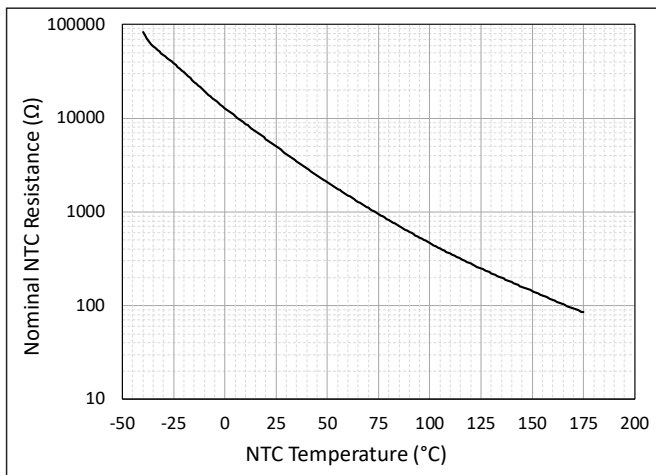

Figure 23. Nominal NTC Resistance vs. NTC Temperature



Timing Characteristics

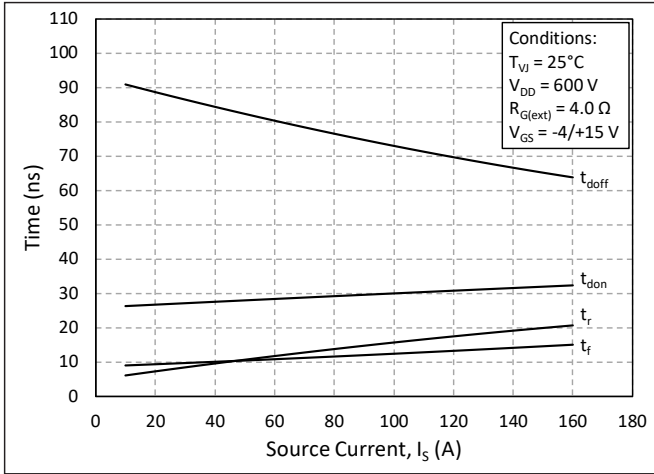

Figure 24. Timing vs. Source Current

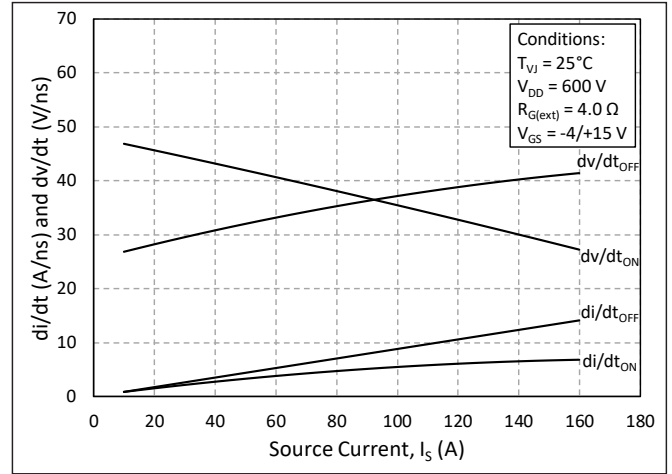

Figure 25. dv/dt and di/dt vs. Source Current

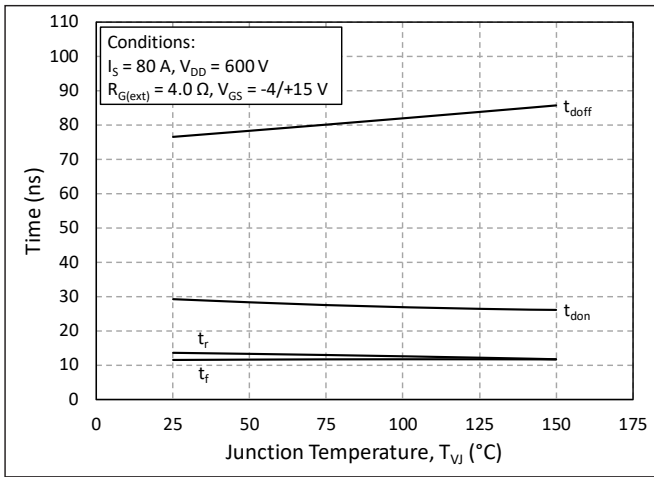

Figure 26. Timing vs. Junction Temperature

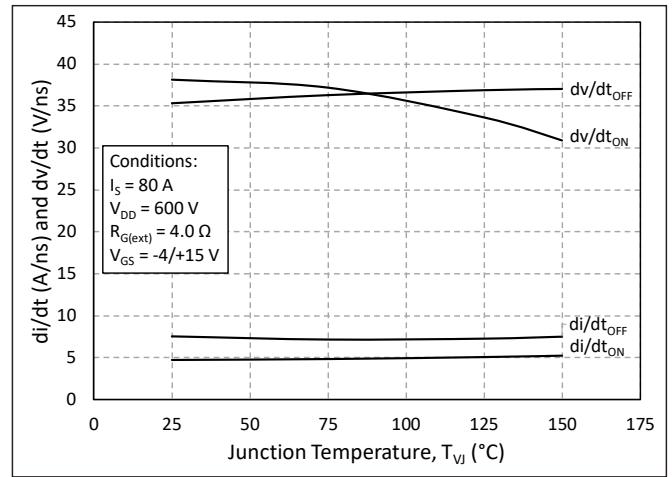

Figure 27. dv/dt and di/dt vs. Junction Temperature

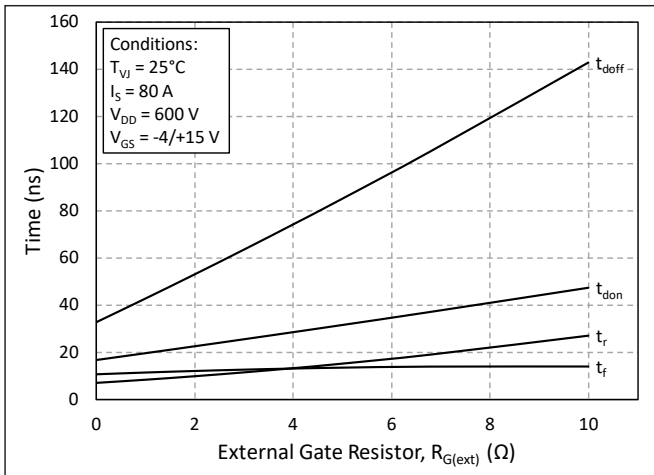

Figure 28. Timing vs. External Gate Resistance

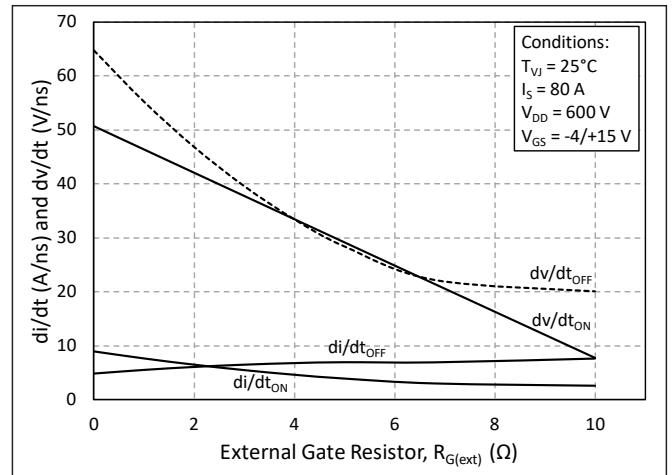
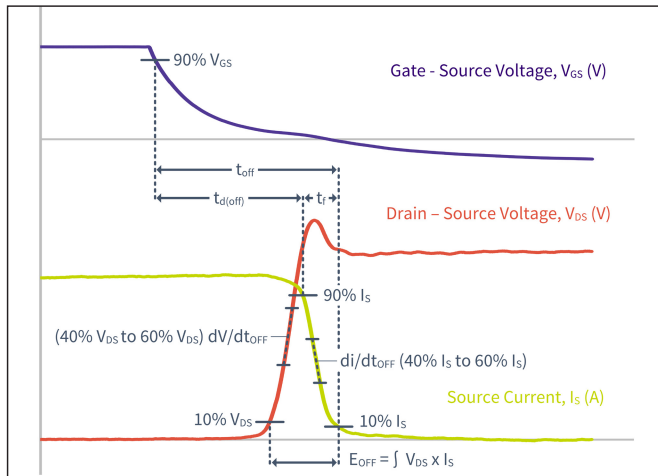

Figure 29. dv/dt and di/dt vs. External Gate Resistance





**Definitions**



**Figure 30.** Turn-off Transient Definitions

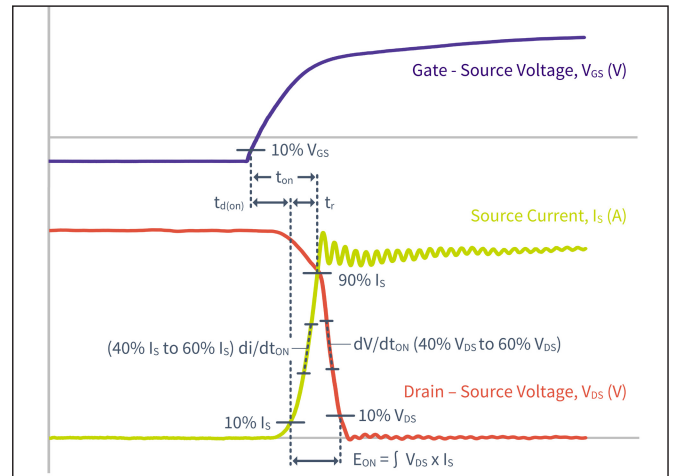

**Figure 31.** Turn-on Transient Definitions

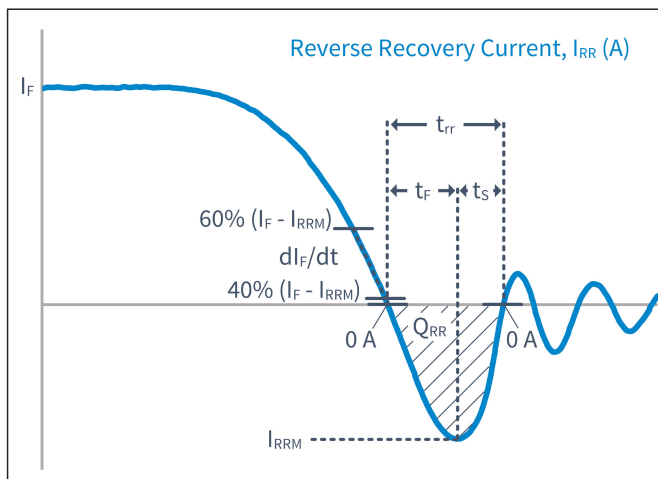

**Figure 32.** Reverse Recovery Definitions

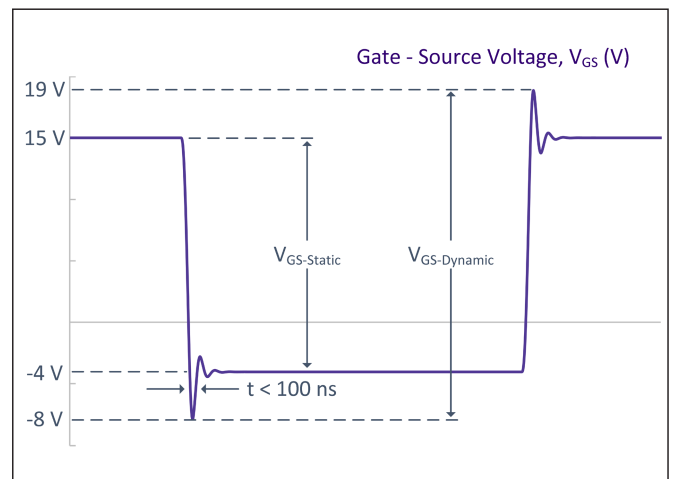

**Figure 33.**  $V_{GS}$  Transient Definitions



**Pinout**

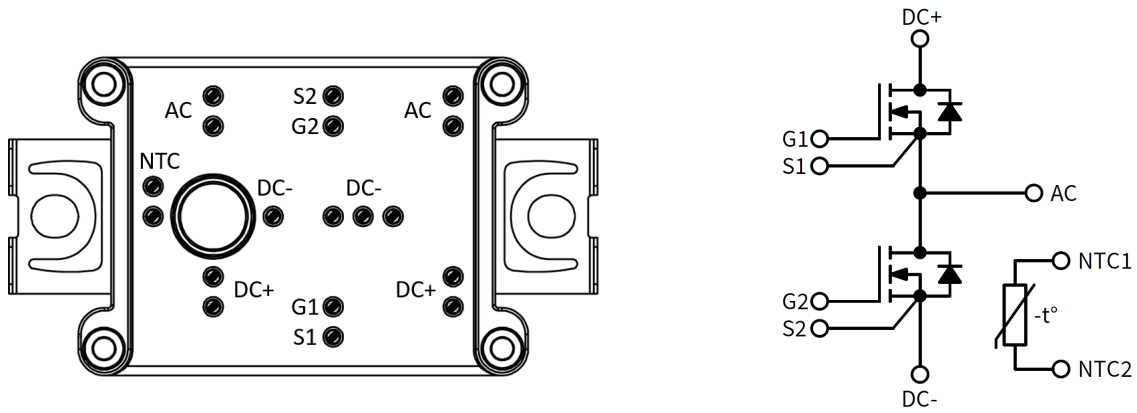

**Package Dimension (mm)**

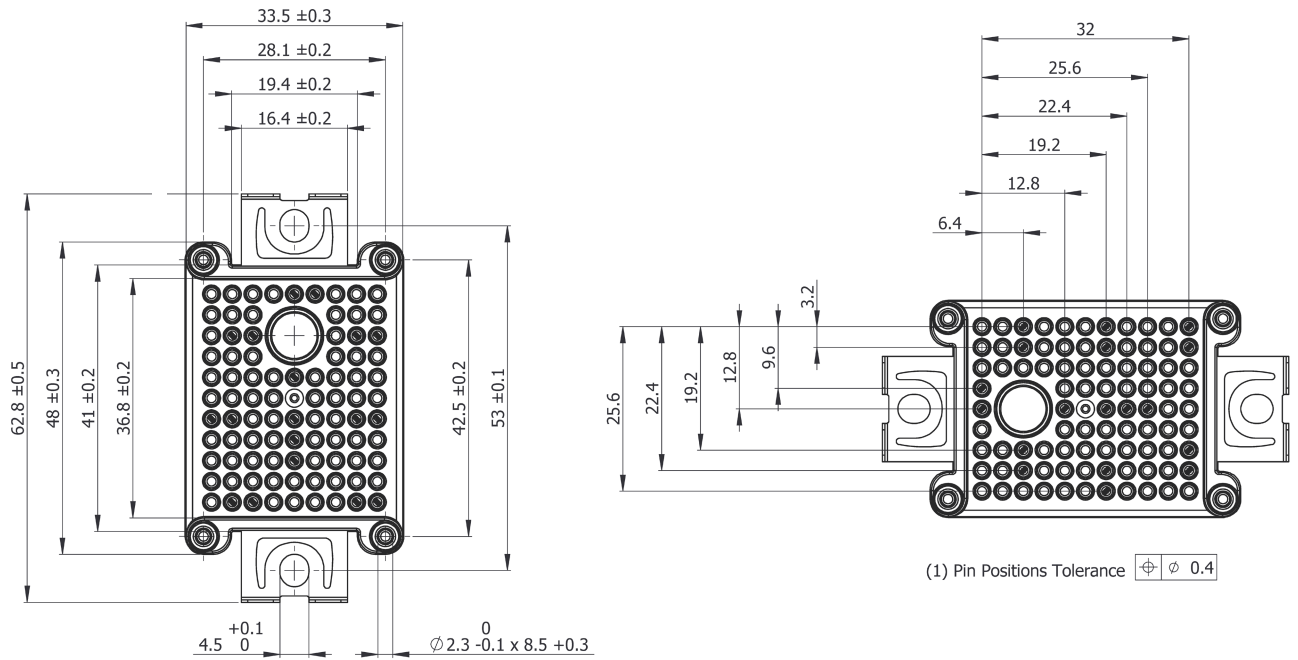



## Product Ordering Code

Part Number	Description
CAB016M12FM3	Without Pre-Applied Phase Change Thermal Interface Material
CAB016M12FM3T	With Pre-Applied Phase Change Thermal Interface Material

## Supporting Links & Tools

### Evaluation Tools & Support

- [All LTSpice Models](#)
- [All PLECS Models](#)
- [KIT-CRD-CIL12N-FMA: Dynamic Evaluation Board for Half-Bridge FM3 Modules](#)
- [SpeedFit 2.0 Design Simulator™](#)
- [Technical Support Forum](#)

### Dual-Channel Gate Driver Board

- [EVAL-ADUM4146WHB1Z: Analog Devices® Gate Driver Board](#)
- [Si823H-AxWA-KIT: Skyworks® Gate Driver Board](#)
- [ACPL-355JC: Broadcom® Gate Driver Board](#)
- [CGD1700HB2M-UNA: Wolfspeed Gate Driver Board](#)
- [CGD12HB00D: Differential Transceiver Daughter Board Companion Tool for Differential Gate Drivers](#)

### Application Notes

- [CPWR-AN41: Mounting Instructions and PCB Requirements](#)
- [CPWR-AN42: Thermal Interface Material Application Note](#)
- [CPWR-AN45: Dynamic Performance Application Note](#)



## Notes & Disclaimer

---

This document and the information contained herein are subject to change without notice. Any such change shall be evidenced by the publication of an updated version of this document by Wolfspeed. No communication from any employee or agent of Wolfspeed or any third party shall effect an amendment or modification of this document. No responsibility is assumed by Wolfspeed for any infringement of patents or other rights of third parties which may result from use of the information contained herein. No license is granted by implication or otherwise under any patent or patent rights of Wolfspeed.

Notwithstanding any application-specific information, guidance, assistance, or support that Wolfspeed may provide, the buyer of this product is solely responsible for determining the suitability of this product for the buyer's purposes, including without limitation for use in the applications identified in the next bullet point, and for the compliance of the buyers' products, including those that incorporate this product, with all applicable legal, regulatory, and safety-related requirements.

This product has not been designed or tested for use in, and is not intended for use in, applications in which failure of the product would reasonably be expected to cause death, personal injury, or property damage, including but not limited to equipment implanted into the human body, life-support machines, cardiac defibrillators, and similar emergency medical equipment, aircraft navigation, communication, and control systems, aircraft power and propulsion systems, air traffic control systems, and equipment used in the planning, construction, maintenance, or operation of nuclear facilities.

### **RoHS Compliance**

The levels of RoHS restricted materials in this product are below the maximum concentration values (also referred to as the threshold limits) permitted for such substances, or are used in an exempted application, in accordance with EU Directive 2011/65/EC (RoHS2), as implemented January 2, 2013. RoHS Declarations for this product can be obtained from your Wolfspeed representative or from the Product Documentation sections of [www.wolfspeed.com](http://www.wolfspeed.com).

### **REACH Compliance**

REACH substances of high concern (SVHCs) information is available for this product. Since the European Chemical Agency (ECHA) has published notice of their intent to frequently revise the SVHC listing for the foreseeable future, please contact your Wolfspeed representative to ensure you get the most up-to-date REACH SVHC Declaration. REACH banned substance information (REACH Article 67) is also available upon request.

### **Contact info:**

4600 Silicon Drive  
Durham, NC 27703 USA  
Tel: +1.919.313.5300  
[www.wolfspeed.com/power](http://www.wolfspeed.com/power)