

SURFACE MOUNT SCHOTTKY BARRIER RECTIFIER

VOLTAGE RANGE 20 to 60 Volts CURRENT 1.0 Ampere

FEATURES

- * Low power loss, high efficiency
- * Low leakage
- * Low forward voltage
- * High current capability
- * High speed switching
- * High surge capability
- * High reliability

MECHANICAL DATA

- * Epoxy: Device has UL flammability classification 94V-O
- * Mounting position: Any
- * Weight: 0.016 gram

MAXIMUM RATINGS AND ELECTRICAL CHARACTERISTICS

Ratings at 25 °C ambient temperature unless otherwise specified.
 Single phase, half wave, 60 Hz, resistive or inductive load.
 For capacitive load, derate current by 20%.



SOD-123FL

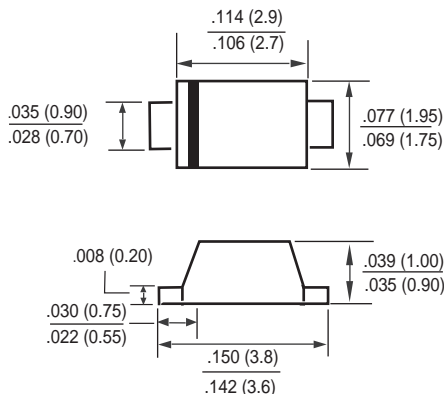

Dimensions in inches and (millimeters)

MAXIMUM RATINGS (At TA = 25°C unless otherwise noted)

RATINGS		SYMBOL	SS2L	SS3L	SS4L	SS5L	SS6L	UNITS
Maximum Recurrent Peak Reverse Voltage		VRRM	20	30	40	50	60	Volts
Maximum RMS Voltage		VRMS	14	21	28	35	42	Volts
Maximum DC Blocking Voltage		Vdc	20	30	40	50	60	Volts
Maximum Average Forward Rectified Current .375" (9.5mm) lead length at TA=55°C		IO	1.0					Amps
Peak Forward Surge Current 8.3 ms single half sine-wave superimposed on rated load (JEDEC method)		IFSM	20					Amps
Typical Junction Capacitance (Note1)		CJ	150					pF
Operating Temperature Range		TJ	-55 to + 150					°C
Storage Temperature Range		TSTG	-55 to + 150					°C

ELECTRICAL CHARACTERISTICS (At TA = 25°C unless otherwise noted)

CHARACTERISTICS		SYMBOL	SS2L	SS3L	SS4L	SS5L	SS6L	UNITS
Maximum Instantaneous Forward Voltage at 1.0A DC		VF	.55		.70			Volts
Maximum Average Reverse Current at Rated DC Blocking Voltage	@ TA = 25°C	IR	1.0					mAmps
	@ TA = 100°C		10					mAmps

NOTES : 1. Measured at 1 MHz and applied reverse voltage of 4.0 volts.
 2. "Fully ROHS compliant", "100% Sn plating (Pb-free)".

RATING AND CHARACTERISTIC CURVES (SS2L THRU SS6L)

FIG. 1 - TYPICAL FORWARD CURRENT DERATING CURVE

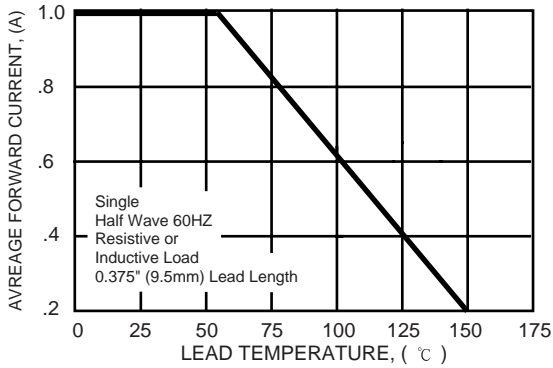

FIG. 2 - TYPICAL INSTANTANEOUS FORWARD CHARACTERISTICS

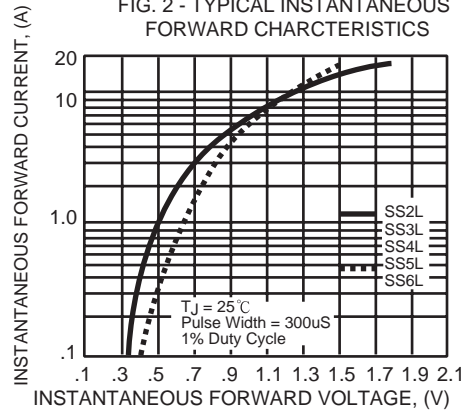

FIG. 3A - TYPICAL REVERSE CHARACTERISTICS

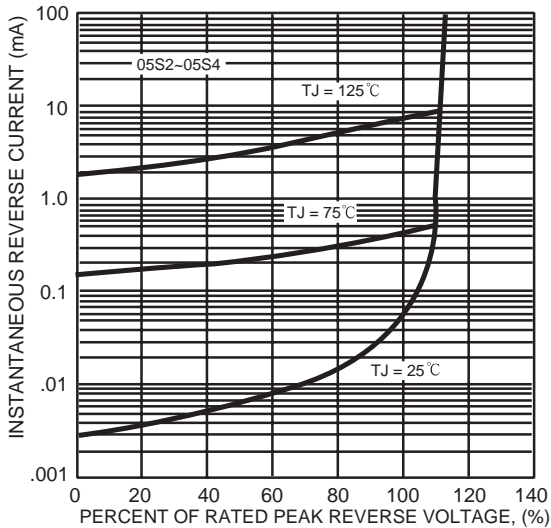

FIG. 3 - TYPICAL REVERSE CHARACTERISTICS

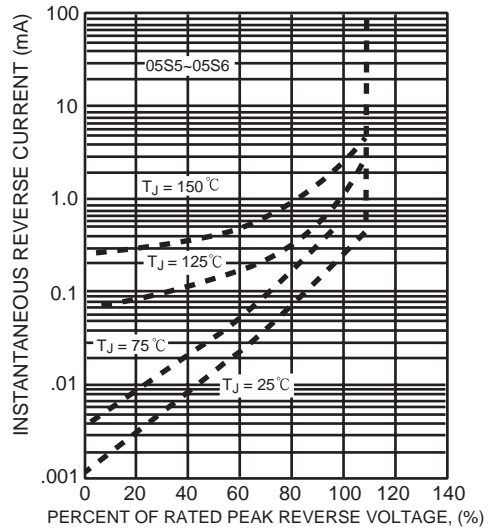

FIG. 4 - TYPICAL JUNCTION CAPACITANCE

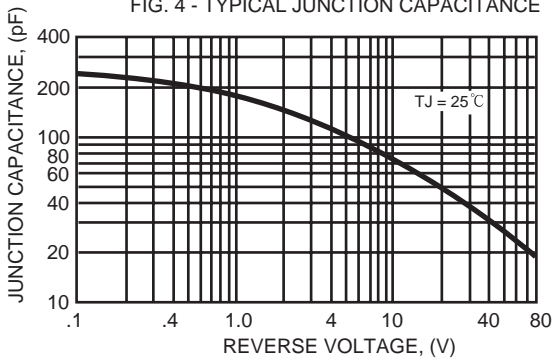
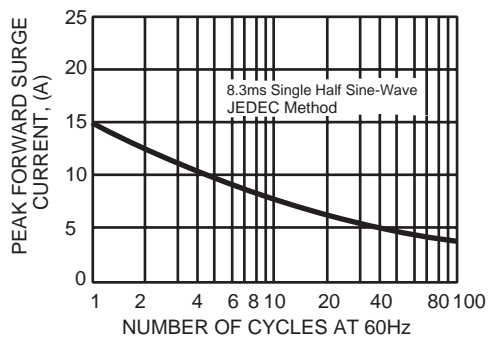
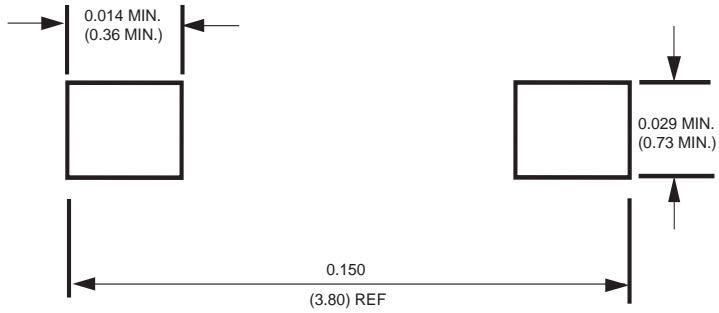

FIG. 5 - MAXIMUM NON-REPETITIVE FORWARD SURGE CURRENT



Mounting Pad Layout



Dimensions in inches and (millimeters)