

# Octal Bus Buffer

## Inverting With 5V-Tolerant Inputs

The MC74LVX240 is an advanced high speed CMOS inverting 3-state octal bus buffer and has two active low output enables. It is also designed to work with 3-state memory address drivers, etc. The inputs tolerate voltages up to 7V, allowing the interface of 5V systems to 3V systems.

- High Speed:  $t_{pD} = 4.3ns$  (Typ) at  $V_{CC} = 3.3V$
- Low Power Dissipation:  $I_{CC} = 4\mu A$  (Max) at  $T_A = 25^\circ C$
- Power Down Protection Provided on Inputs
- Balanced Propagation Delays
- Low Noise:  $V_{OLP} = 0.8V$  (Max)
- Pin and Function Compatible with Other Standard Logic Families
- Latchup Performance Exceeds 300mA
- ESD Performance: HBM > 2000V; Machine Model > 200V

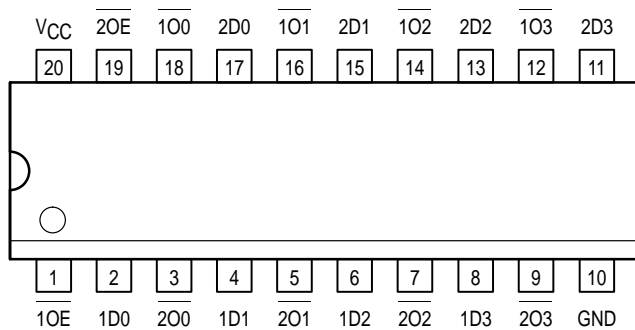


Figure 1. 20-Lead Pinout (Top View)

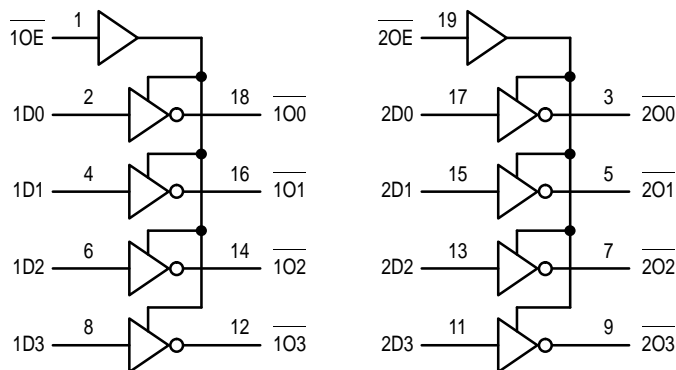
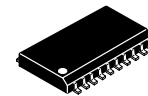


Figure 2. Logic Diagram

**MC74LVX240**

**LVX**

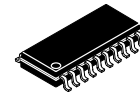
**LOW-VOLTAGE CMOS**



**DW SUFFIX**  
20-LEAD SOIC PACKAGE  
CASE 751D-04



**DT SUFFIX**  
20-LEAD TSSOP PACKAGE  
CASE 948E-02



**M SUFFIX**  
20-LEAD SOIC EIAJ PACKAGE  
CASE 967-01

**PIN NAMES**

Pins	Function
nOE	Output Enable Inputs
1Dn, 2Dn	Data Inputs
1On, 2On	3-State Outputs

**FUNCTION TABLE**

INPUTS		OUTPUTS
1OE, 2OE	1Dn, 2Dn	1On, 2On
L	L	L
L	H	H
H	X	Z



# MC74LVX240

## MAXIMUM RATINGS\*

Symbol	Parameter	Value	Unit
V <sub>CC</sub>	DC Supply Voltage	-0.5 to +7.0	V
V <sub>in</sub>	DC Input Voltage	-0.5 to +7.0	V
V <sub>out</sub>	DC Output Voltage	-0.5 to V <sub>CC</sub> +0.5	V
I <sub>IJK</sub>	Input Diode Current	-20	mA
I <sub>OK</sub>	Output Diode Current	±20	mA
I <sub>out</sub>	DC Output Current, per Pin	±25	mA
I <sub>CC</sub>	DC Supply Current, V <sub>CC</sub> and GND Pins	±75	mA
P <sub>D</sub>	Power Dissipation	180	mW
T <sub>stg</sub>	Storage Temperature	-65 to +150	°C

\* Absolute maximum continuous ratings are those values beyond which damage to the device may occur. Exposure to these conditions or conditions beyond those indicated may adversely affect device reliability. Functional operation under absolute-maximum-rated conditions is not implied.

## RECOMMENDED OPERATING CONDITIONS

Symbol	Parameter	Min	Max	Unit
V <sub>CC</sub>	DC Supply Voltage	2.0	3.6	V
V <sub>in</sub>	DC Input Voltage	0	5.5	V
V <sub>out</sub>	DC Output Voltage	0	V <sub>CC</sub>	V
T <sub>A</sub>	Operating Temperature, All Package Types	-40	+85	°C
Δt/ΔV	Input Rise and Fall Time	0	100	ns/V

## DC ELECTRICAL CHARACTERISTICS

Symbol	Parameter	Test Conditions	V <sub>CC</sub> V	T <sub>A</sub> = 25°C			T <sub>A</sub> = -40 to 85°C		Unit
				Min	Typ	Max	Min	Max	
V <sub>IH</sub>	High-Level Input Voltage		2.0	1.5			1.5		V
			3.0	2.0			2.0		
			3.6	2.4			2.4		
V <sub>IL</sub>	Low-Level Input Voltage		2.0			0.5		0.5	V
			3.0			0.8		0.8	
			3.6			0.8		0.8	
V <sub>OH</sub>	High-Level Output Voltage (V <sub>in</sub> = V <sub>IH</sub> or V <sub>IL</sub> )	I <sub>OH</sub> = -50μA I <sub>OH</sub> = -50μA I <sub>OH</sub> = -4mA	2.0	1.9	2.0		1.9		V
			3.0	2.9	3.0		2.9		
			3.0	2.58			2.48		
V <sub>OL</sub>	Low-Level Output Voltage (V <sub>in</sub> = V <sub>IH</sub> or V <sub>IL</sub> )	I <sub>OL</sub> = 50μA I <sub>OL</sub> = 50μA I <sub>OL</sub> = 4mA	2.0		0.0	0.1		0.1	V
			3.0		0.0	0.1		0.1	
			3.0			0.36		0.44	
I <sub>in</sub>	Input Leakage Current	V <sub>in</sub> = 5.5V or GND	3.6			±0.1		±1.0	μA
I <sub>oZ</sub>	Maximum Three-State Leakage Current	V <sub>in</sub> = V <sub>IL</sub> or V <sub>IH</sub> V <sub>out</sub> = V <sub>CC</sub> or GND	3.6			±0.25		±2.5	μA
I <sub>CC</sub>	Quiescent Supply Current	V <sub>in</sub> = V <sub>CC</sub> or GND	3.6			4.0		40.0	μA

**AC ELECTRICAL CHARACTERISTICS** (Input  $t_r = t_f = 3.0\text{ns}$ )

Symbol	Parameter	Test Conditions	$T_A = 25^\circ\text{C}$			$T_A = -40 \text{ to } 85^\circ\text{C}$		Unit
			Min	Typ	Max	Min	Max	
$t_{PLH}$ , $t_{PHL}$	Propagation Delay Input to Output	$V_{CC} = 2.7\text{V}$ $C_L = 15\text{pF}$		5.7	10.1	1.0	12.5	ns
		$C_L = 50\text{pF}$		8.2	13.6	1.0	16.0	
		$V_{CC} = 3.3 \pm 0.3\text{V}$ $C_L = 15\text{pF}$		4.3	6.2	1.0	7.5	
		$C_L = 50\text{pF}$		6.8	9.7	1.0	11.0	
$t_{PZL}$ , $t_{PZH}$	Output Enable Time to High and Low Level	$V_{CC} = 2.7\text{V}$ $C_L = 15\text{pF}$		7.1	13.8	1.0	16.5	ns
		$R_L = 1\text{k}\Omega$ $C_L = 50\text{pF}$		9.6	17.3	1.0	20.0	
		$V_{CC} = 3.3 \pm 0.3\text{V}$ $C_L = 15\text{pF}$		5.5	8.8	1.0	10.5	
		$R_L = 1\text{k}\Omega$ $C_L = 50\text{pF}$		8.0	12.3	1.0	14.0	
$t_{PLZ}$ , $t_{PHZ}$	Output Disable Time From High and Low Level	$V_{CC} = 2.7\text{V}$ $C_L = 50\text{pF}$		11.6	16.0	1.0	19.0	ns
		$R_L = 1\text{k}\Omega$						
$t_{OSHL}$ , $t_{OSLH}$	Output-to-Output Skew (Note 1.)	$V_{CC} = 2.7\text{V}$ $C_L = 50\text{pF}$			1.5		1.5	ns
		$V_{CC} = 3.3 \pm 0.3\text{V}$ $C_L = 50\text{pF}$			1.5		1.5	

1. Skew is defined as the absolute value of the difference between the actual propagation delay for any two separate outputs of the same device. The specification applies to any outputs switching in the same direction, either HIGH-to-LOW ( $t_{OSHL}$ ) or LOW-to-HIGH ( $t_{OSLH}$ ); parameter guaranteed by design.

**CAPACITIVE CHARACTERISTICS**

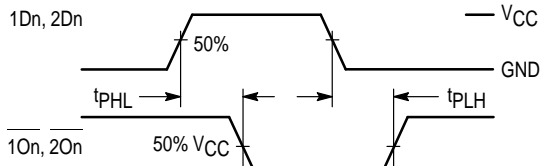
Symbol	Parameter	$T_A = 25^\circ\text{C}$			$T_A = -40 \text{ to } 85^\circ\text{C}$		Unit
		Min	Typ	Max	Min	Max	
$C_{in}$	Input Capacitance		4	10		10	pF
$C_{out}$	Maximum Three-State Output Capacitance		6				pF
$C_{PD}$	Power Dissipation Capacitance (Note 2.)		19				pF

2.  $C_{PD}$  is defined as the value of the internal equivalent capacitance which is calculated from the operating current consumption without load. Average operating current can be obtained by the equation:  $I_{CC(OPR)} = C_{PD} \cdot V_{CC} \cdot f_{in} + I_{CC}/8$  (per bit).  $C_{PD}$  is used to determine the no-load dynamic power consumption;  $P_D = C_{PD} \cdot V_{CC}^2 \cdot f_{in} + I_{CC} \cdot V_{CC}$ .

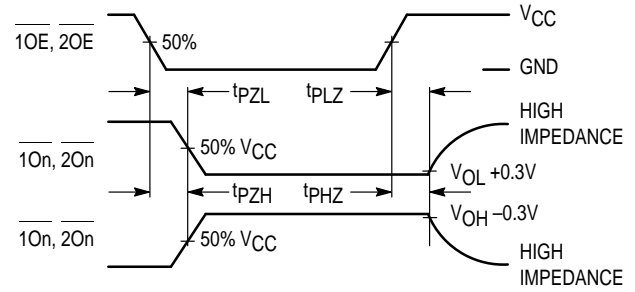
**NOISE CHARACTERISTICS** (Input  $t_r = t_f = 3.0\text{ns}$ ,  $C_L = 50\text{pF}$ ,  $V_{CC} = 3.3\text{V}$ , Measured in SOIC Package)

Symbol	Characteristic	$T_A = 25^\circ\text{C}$		Unit
		Typ	Max	
$V_{OLP}$	Quiet Output Maximum Dynamic $V_{OL}$	0.5	0.8	V
$V_{OLV}$	Quiet Output Minimum Dynamic $V_{OL}$	-0.5	-0.8	V
$V_{IHD}$	Minimum High Level Dynamic Input Voltage		2.0	V
$V_{ILD}$	Maximum Low Level Dynamic Input Voltage		0.8	V

**SWITCHING WAVEFORMS**

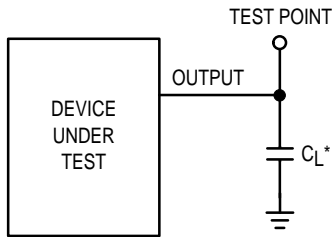


**Figure 3.**



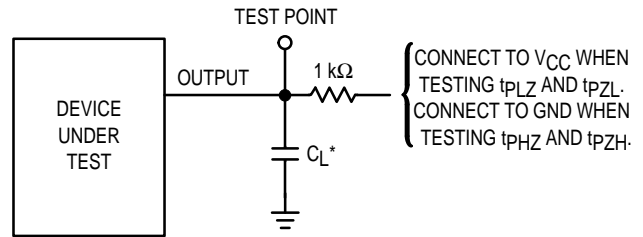
**Figure 4.**

**TEST CIRCUITS**



\* Includes all probe and jig capacitance

**Figure 5. Propagation Delay Test Circuit**

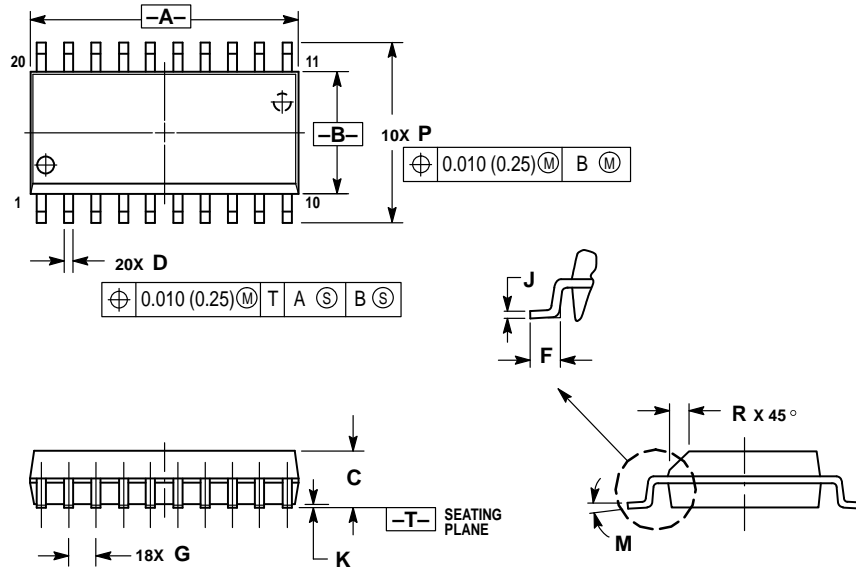


\* Includes all probe and jig capacitance

**Figure 6. Three-State Test Circuit**

OUTLINE DIMENSIONS

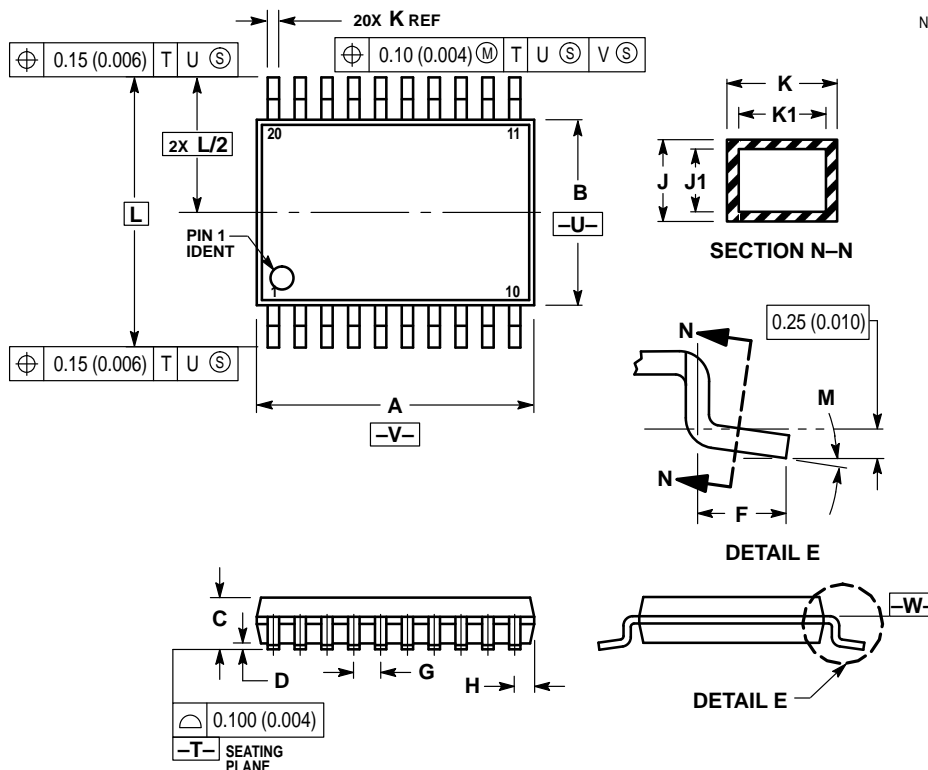
DW SUFFIX  
PLASTIC SOIC PACKAGE  
CASE 751D-04  
ISSUE E



- NOTES:
1. DIMENSIONING AND TOLERANCING PER ANSI Y14.5M, 1982.
  2. CONTROLLING DIMENSION: MILLIMETER.
  3. DIMENSIONS A AND B DO NOT INCLUDE MOLD PROTRUSION.
  4. MAXIMUM MOLD PROTRUSION 0.150 (0.006) PER SIDE.
  5. DIMENSION D DOES NOT INCLUDE DAMBAR PROTRUSION. ALLOWABLE DAMBAR PROTRUSION SHALL BE 0.13 (0.005) TOTAL IN EXCESS OF D DIMENSION AT MAXIMUM MATERIAL CONDITION.

DIM	MILLIMETERS		INCHES	
	MIN	MAX	MIN	MAX
A	12.65	12.95	0.499	0.510
B	7.40	7.60	0.292	0.299
C	2.35	2.65	0.093	0.104
D	0.35	0.49	0.014	0.019
F	0.50	0.90	0.020	0.035
G	1.27 BSC		0.050 BSC	
J	0.25	0.32	0.010	0.012
K	0.10	0.25	0.004	0.009
M	0°	7°	0°	7°
P	10.05	10.55	0.395	0.415
R	0.25	0.75	0.010	0.029

DT SUFFIX  
PLASTIC TSSOP PACKAGE  
CASE 948E-02  
ISSUE A

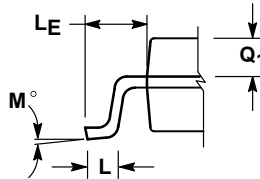
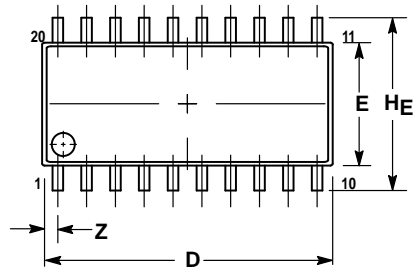


- NOTES:
1. DIMENSIONING AND TOLERANCING PER ANSI Y14.5M, 1982.
  2. CONTROLLING DIMENSION: MILLIMETER.
  3. DIMENSION A DOES NOT INCLUDE MOLD FLASH, PROTRUSIONS OR GATE BURRS. MOLD FLASH OR GATE BURRS SHALL NOT EXCEED 0.15 (0.006) PER SIDE.
  4. DIMENSION B DOES NOT INCLUDE INTERLEAD FLASH OR PROTRUSION. INTERLEAD FLASH OR PROTRUSION SHALL NOT EXCEED 0.25 (0.010) PER SIDE.
  5. DIMENSION K DOES NOT INCLUDE DAMBAR PROTRUSION. ALLOWABLE DAMBAR PROTRUSION SHALL BE 0.08 (0.003) TOTAL IN EXCESS OF THE K DIMENSION AT MAXIMUM MATERIAL CONDITION.
  6. TERMINAL NUMBERS ARE SHOWN FOR REFERENCE ONLY.
  7. DIMENSION A AND B ARE TO BE DETERMINED AT DATUM PLANE -W-.

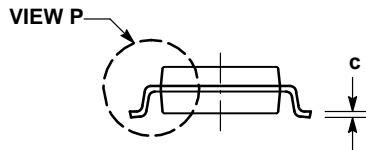
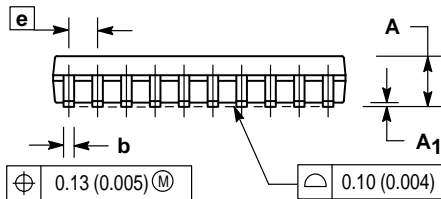
DIM	MILLIMETERS		INCHES	
	MIN	MAX	MIN	MAX
A	6.40	6.60	0.252	0.260
B	4.30	4.50	0.169	0.177
C	—	1.20	—	0.047
D	0.05	0.15	0.002	0.006
F	0.50	0.75	0.020	0.030
G	0.65 BSC		0.026 BSC	
H	0.27	0.37	0.011	0.015
J	0.09	0.20	0.004	0.008
J1	0.09	0.16	0.004	0.006
K	0.19	0.30	0.007	0.012
K1	0.19	0.25	0.007	0.010
L	6.40 BSC		0.252 BSC	
M	0°	8°	0°	8°

OUTLINE DIMENSIONS

M SUFFIX  
PLASTIC SOIC EIAJ PACKAGE  
CASE 967-01  
ISSUE O




DETAIL P



NOTES:

- 1 DIMENSIONING AND TOLERANCING PER ANSI Y14.5M, 1982.
- 2 CONTROLLING DIMENSION: MILLIMETER.
- 3 DIMENSIONS D AND E DO NOT INCLUDE MOLD FLASH OR PROTRUSIONS AND ARE MEASURED AT THE PARTING LINE. MOLD FLASH OR PROTRUSIONS SHALL NOT EXCEED 0.15 (0.006) PER SIDE.
- 4 TERMINAL NUMBERS ARE SHOWN FOR REFERENCE ONLY.
- 5 THE LEAD WIDTH DIMENSION (b) DOES NOT INCLUDE DAMBAR PROTRUSION. ALLOWABLE DAMBAR PROTRUSION SHALL BE 0.08 (0.003) TOTAL IN EXCESS OF THE LEAD WIDTH DIMENSION AT MAXIMUM MATERIAL CONDITION. DAMBAR CANNOT BE LOCATED ON THE LOWER RADIUS OR THE FOOT. MINIMUM SPACE BETWEEN PROTRUSIONS AND ADJACENT LEAD TO BE 0.46 (0.018).

DIM	MILLIMETERS		INCHES	
	MIN	MAX	MIN	MAX
A	—	2.05	—	0.081
A <sub>1</sub>	0.05	0.20	0.002	0.008
b	0.35	0.50	0.014	0.020
c	0.18	0.27	0.007	0.011
D	12.35	12.80	0.486	0.504
E	5.10	5.45	0.201	0.215
e	1.27 BSC	—	0.050 BSC	—
H <sub>E</sub>	7.40	8.20	0.291	0.323
L	0.50	0.85	0.020	0.033
L <sub>E</sub>	1.10	1.50	0.043	0.059
M	0°	10°	0°	10°
Q <sub>1</sub>	0.70	0.90	0.028	0.035
Z	—	0.81	—	0.032

Motorola reserves the right to make changes without further notice to any products herein. Motorola makes no warranty, representation or guarantee regarding the suitability of its products for any particular purpose, nor does Motorola assume any liability arising out of the application or use of any product or circuit, and specifically disclaims any and all liability, including without limitation consequential or incidental damages. "Typical" parameters which may be provided in Motorola data sheets and/or specifications can and do vary in different applications and actual performance may vary over time. All operating parameters, including "Typicals" must be validated for each customer application by customer's technical experts. Motorola does not convey any license under its patent rights nor the rights of others. Motorola products are not designed, intended, or authorized for use as components in systems intended for surgical implant into the body, or other applications intended to support or sustain life, or for any other application in which the failure of the Motorola product could create a situation where personal injury or death may occur. Should Buyer purchase or use Motorola products for any such unintended or unauthorized application, Buyer shall indemnify and hold Motorola and its officers, employees, subsidiaries, affiliates, and distributors harmless against all claims, costs, damages, and expenses, and reasonable attorney fees arising out of, directly or indirectly, any claim of personal injury or death associated with such unintended or unauthorized use, even if such claim alleges that Motorola was negligent regarding the design or manufacture of the part. Motorola and  are registered trademarks of Motorola, Inc. Motorola, Inc. is an Equal Opportunity/Affirmative Action Employer.

Mfax is a trademark of Motorola, Inc.

How to reach us:

USA/EUROPE/Locations Not Listed: Motorola Literature Distribution; P.O. Box 5405, Denver, Colorado 80217. 303-675-2140 or 1-800-441-2447

JAPAN: Nippon Motorola Ltd.: SPD, Strategic Planning Office, 4-32-1, Nishi-Gotanda, Shinagawa-ku, Tokyo 141, Japan. 81-3-5487-8488

Mfax™: RMFAX0@email.sps.mot.com — TOUCHTONE 602-244-6609  
— US & Canada ONLY 1-800-774-1848

ASIA/PACIFIC: Motorola Semiconductors H.K. Ltd.; 8B Tai Ping Industrial Park, 51 Ting Kok Road, Tai Po, N.T., Hong Kong. 852-26629298

INTERNET: <http://motorola.com/sps>

