

Silicon NPN Power Transistors

2SC1846

DESCRIPTION

- With TO-126 package
- Complement to type 2SA885
- Low collector saturation

APPLICATIONS

- For medium output power amplification

PINNING

PIN	DESCRIPTION
1	Emitter
2	Collector;connected to mounting base
3	Base

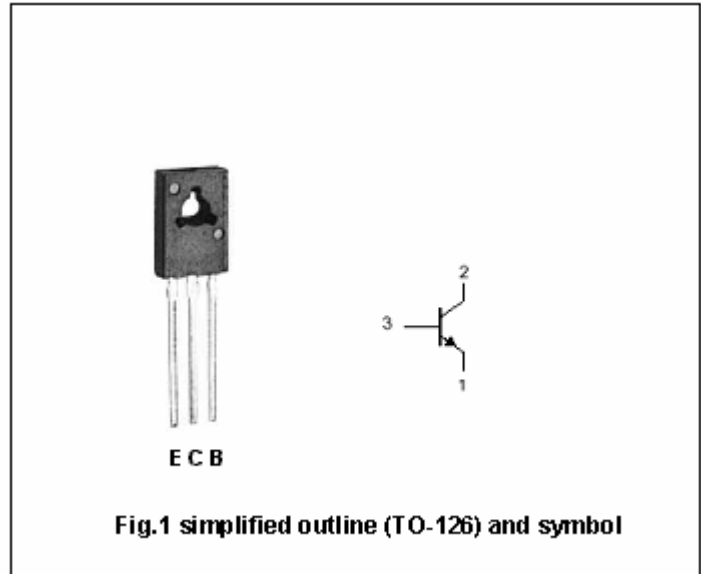

Absolute Maximum Ratings (Ta=25)

SYMBOL	PARAMETER	CONDITIONS	VALUE	UNIT
V _{CBO}	Collector-base voltage	Open emitter	45	V
V _{CEO}	Collector-emitter voltage	Open base	35	V
V _{EBO}	Emitter-base voltage	Open collector	5	V
I _C	Collector current (DC)		1	A
I _{CM}	Collector current-peak		1.5	A
P _C	Collector power dissipation	T _C =25	1.2 ^{*1}	W
			5 ^{*2}	
T _j	Junction temperature		150	
T _{stg}	Storage temperature		-55~150	

Note) *1: Without heat sink

*2: With a 100 × 100 × 2 mm A1 heat sink

Silicon NPN Power Transistors

2SC1846

CHARACTERISTICS

T_j=25 unless otherwise specified

SYMBOL	PARAMETER	CONDITIONS	MIN	TYP.	MAX	UNIT
V _{(BR)CEO}	Collector-emitter breakdown voltage	I _C =2mA; I _B =0	35			V
V _{(BR)CBO}	Collector-base breakdown voltage	I _C =1mA; I _E =0	45			V
V _{CEsat}	Collector-emitter saturation voltage	I _C =0.5A; I _B =50mA			0.5	V
I _{CBO}	Collector cut-off current	V _{CB} =20V; I _E =0			0.1	μA
I _{CEO}	Collector cut-off current	V _{CE} =20V; I _B =0			100	μA
I _{EBO}	Emitter cut-off current	V _{EB} =5V; I _C =0			10	μA
h _{FE-1}	DC current gain	I _C =0.5A; V _{CE} =10V	85		340	
h _{FE-2}	DC current gain	I _C =1A; V _{CE} =5V	50			
C _{OB}	Output capacitance	I _E =0; V _{CB} =10V; f=1MHz			20	pF
f _T	Transition frequency	I _C =50mA; V _{CB} =10V, f=200MHz		200		MHz

◆ h_{FE-1} Classifications

Q	R	S
85-170	120-240	170-340

Silicon NPN Power Transistors

2SC1846

PACKAGE OUTLINE

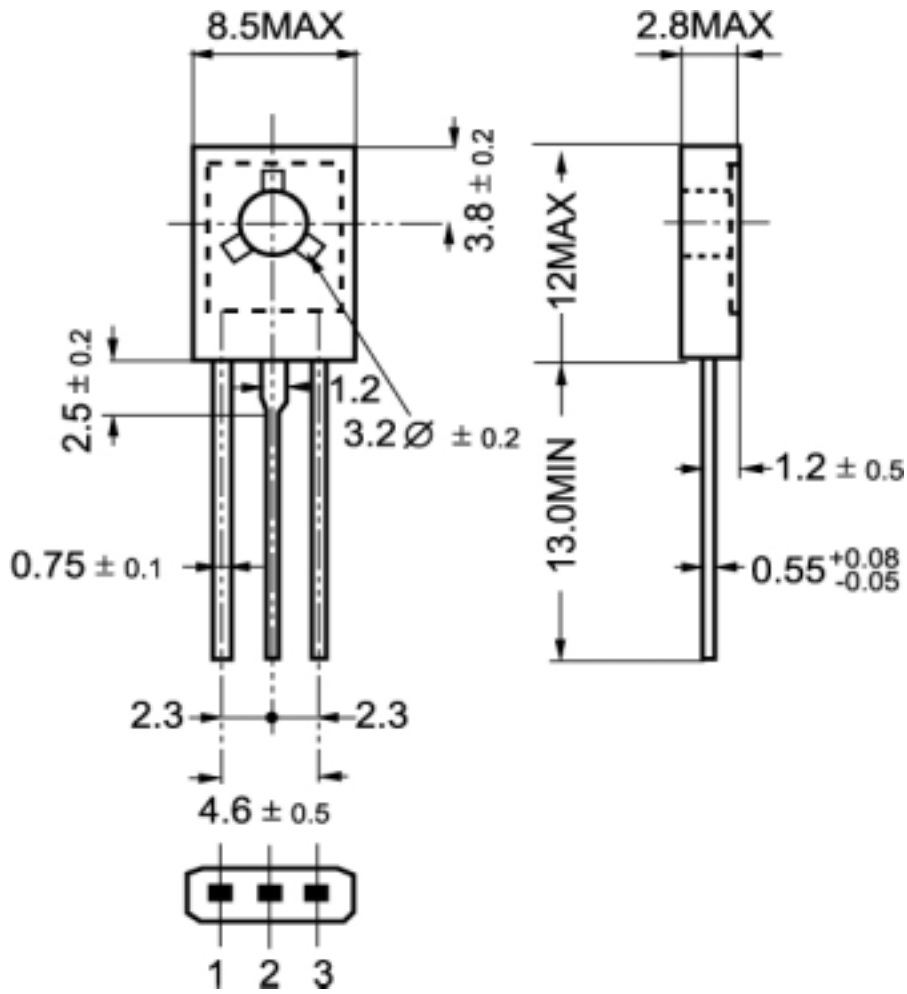

Fig.2 Outline dimensions

Silicon NPN Power Transistors

2SC1846

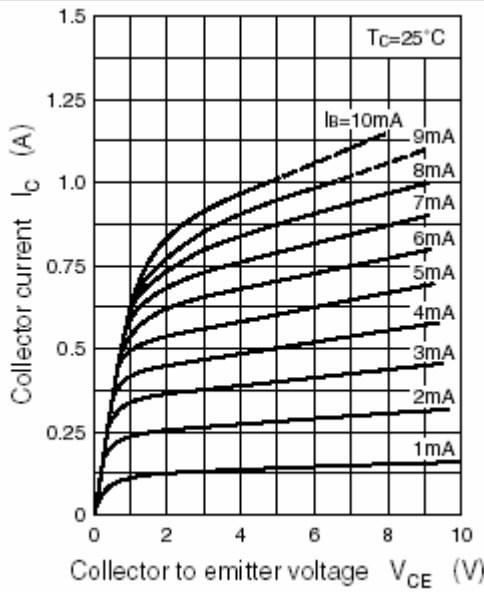

Fig.3 Static Characteristic

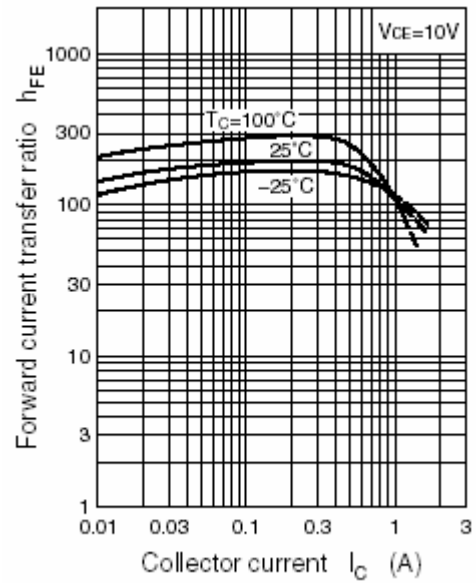

Fig.4 DC current Gain

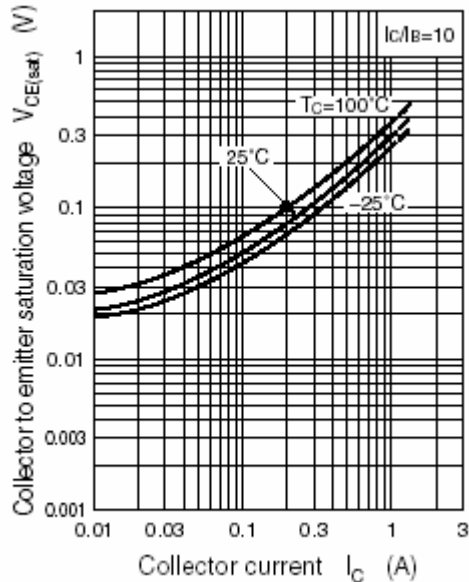

Fig.5 Collector-Emitter Saturation Voltage

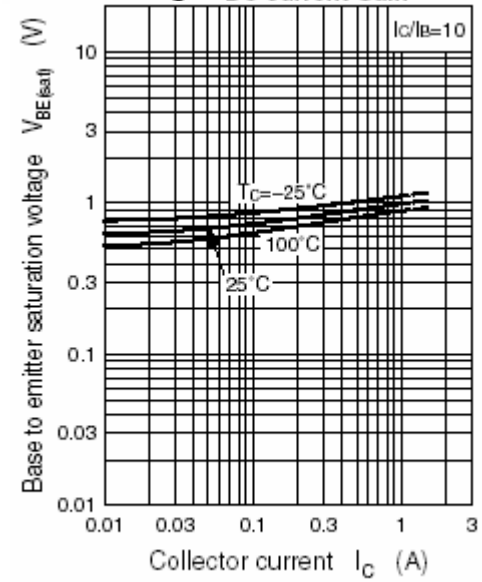

Fig.6 Base-Emitter Saturation Voltage

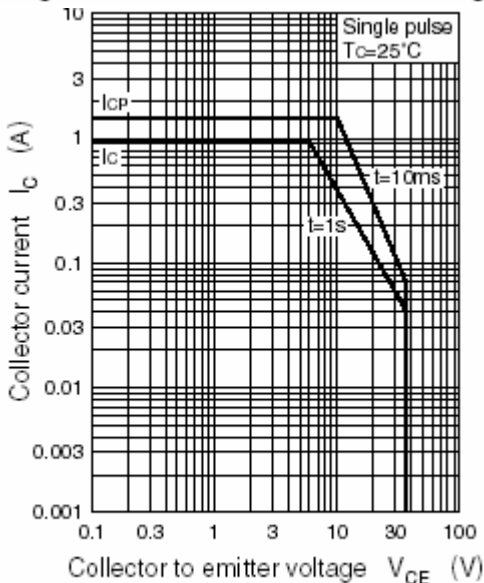

Fig.7 Safe Operating Area