

Description

PxxxxTB-MC Series SMA thyristor surge suppressors protect telecommunications equipment such as modems, line cards, fax machines, and other CPE.

The Series are used to enable equipment to meet various regulatory requirements including GR 1089, ITU K.20, K.21 and K.45, IEC 60950, UL 60950, and TIA-968 (formerly known as FCC Part 68).



SMA (DO-214AC)

Features

- Silicon technology
- Cannot be damaged by voltage
- Very Low capacitance
- Eliminate voltage overshoot
- Epoxy resin package
- Will not fatigue
- Complies with following standards:
 - GR1089
 - ITU K.20, K.21 and K.45
 - IEC 60950
 - UL 60950
 - TIA-968
- RoHS Compliant

Mechanical Characteristics

- Package: SMA (2.67×5.3×2.2mm)
- Lead Finish: Matte Tin
- Case Material: "Green" Molding Compound.
- UL Flammability Classification Rating 94V-0
- Moisture Sensitivity: Level 1 per J-STD-020

Applications

- COMMERCIAL SYSTEMS
- INDUSTRIAL & INSTRUMENTATION
- COMMUNICATIONS

Marking Information

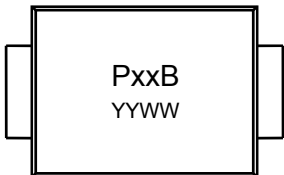

PxxB = Type Code
YYWW = Date Code

Pin Configuration

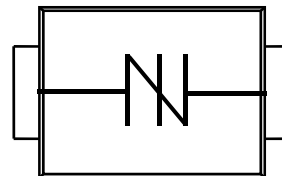

Summary of Packing Options

Package	Packing Description	Packing Quantity	Industry Standard
SMA	Tape/Reel, 11" reel	5000	EIA-481-1
	Tape/Reel, 7" reel	2000	EIA-481-1

Absolute Maximum Ratings

Parameter	Symbol	Value	Units	Remarks
Peak Pulse Voltage	V_{PP}	4000	V	10/700us
Peak Pulse Current	I_{PP}	80	A	10/1000us
Peak Pulse Current	I_{PK}	250	A	8/20us
Peak One-cycle Surge Current	I_{TSM}	25	A	60Hz
Rate of Rise of Current	di/dt	500	A/us	
Typical Thermal Resistance Junction to Lead	$R_{\theta JL}$	30	°C/W	
Typical Thermal Resistance Junction to Ambient	$R_{\theta JA}$	120	°C/W	
Operating Temperature Range	T_J	-40 to 150	°C	
Storage Temperature Range	T_{STG}	-55 to 150	°C	

Electrical Characteristics ($T_A=25^\circ\text{C}$ unless otherwise noted)

Part Number	Marking	I_H	V_S	I_{S_MAX}	V_T	I_T	I_D	V_D	C_O
		mA	V 100KV/S MAX	mA	V @ I_T MAX	A	uA @ V_D MAX	V	pF 1MHz, 2V _{DC} TYP
P0080TB-MC	P008B	40	25	500	4	2.2	5	6	29
P0220TB-MC	P02B	40	30	500	4	2.2	5	15	29
P0300TB-MC	P03B	40	40	500	4	2.2	5	25	28
P0640TB-MC	P06B	120	77	800	4	2.2	5	58	27
P0720TB-MC	P07B	120	88	800	4	2.2	5	65	27
P0900TB-MC	P09B	120	98	800	4	2.2	5	75	27
P1100TB-MC	P11B	120	130	800	4	2.2	5	90	25
P1300TB-MC	P13B	120	160	800	4	2.2	5	120	25
P1500TB-MC	P15B	120	180	800	4	2.2	5	140	24
P1800TB-MC	P18B	120	220	800	4	2.2	5	170	22
P2300TB-MC	P23B	120	260	800	4	2.2	5	190	21
P2600TB-MC	P26B	120	300	800	4	2.2	5	220	20
P3100TB-MC	P31B	120	350	800	4	2.2	5	275	18
P3500TB-MC	P35B	120	400	800	4	2.2	5	320	17
P4500TB-MC	P45B	120	530	800	4	2.2	5	400	13

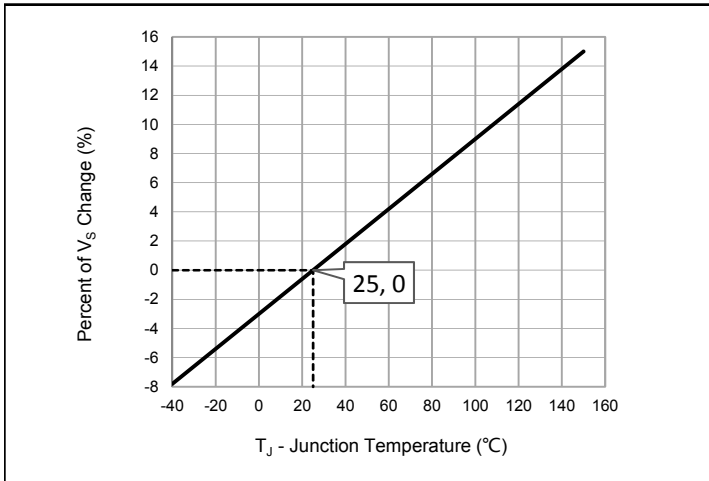
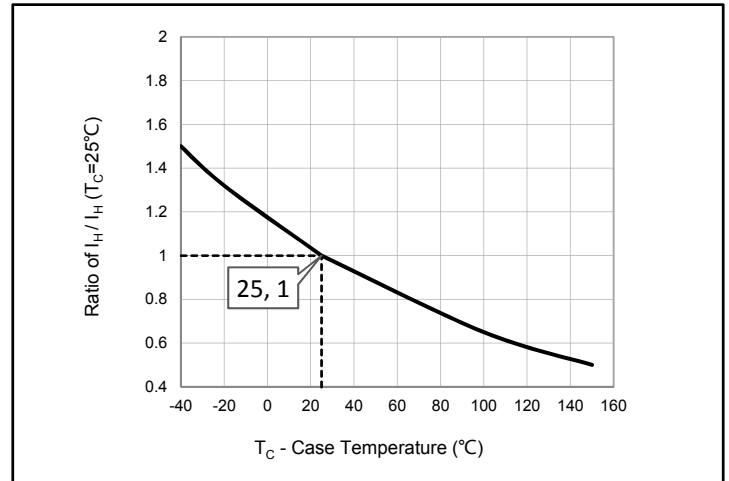
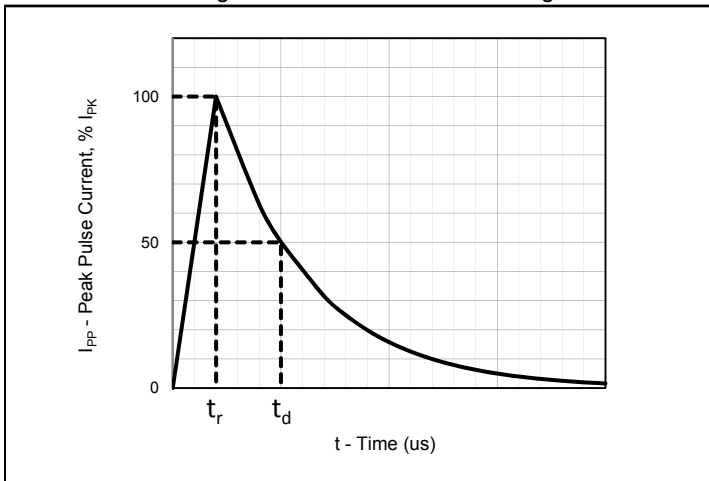
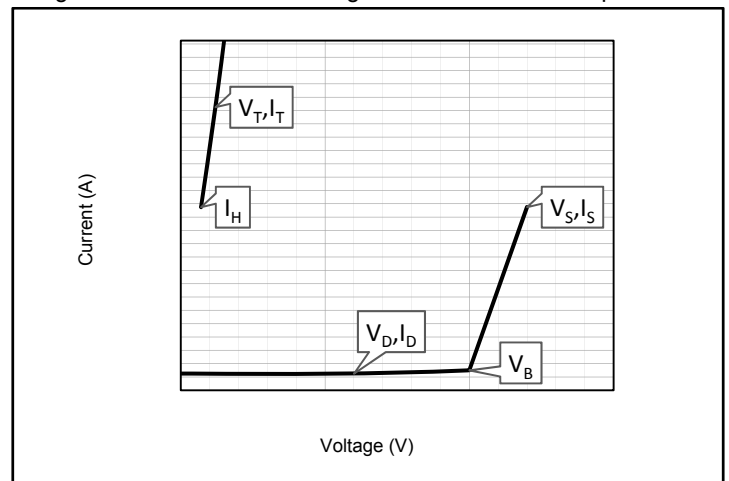
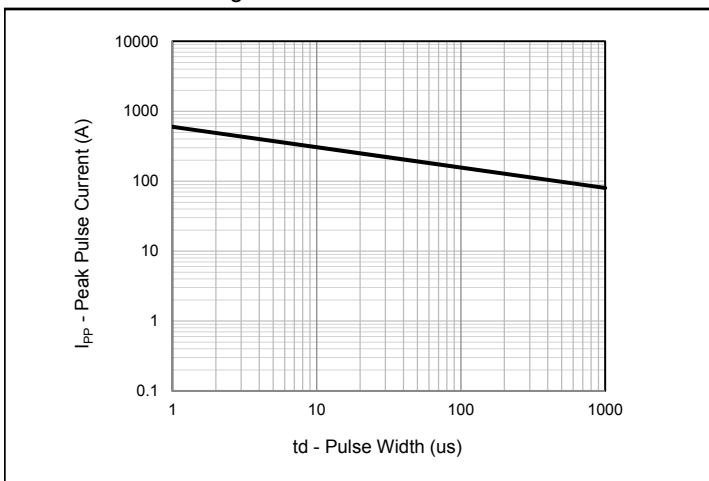
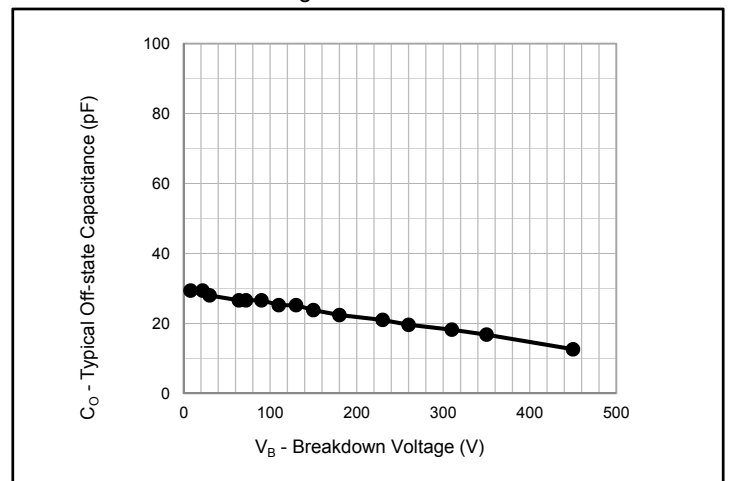
Rating And Characteristic Curves ($T_A=25^\circ\text{C}$ unless otherwise noted)

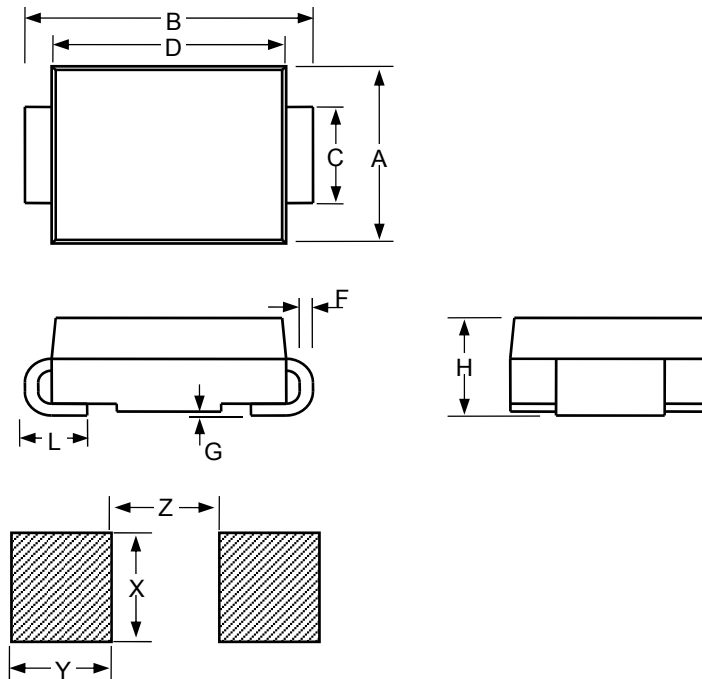
Fig.1 - Peak Pulse Current Rating

Fig.2 - Normalized DC Holding Current vs. Case Temperature

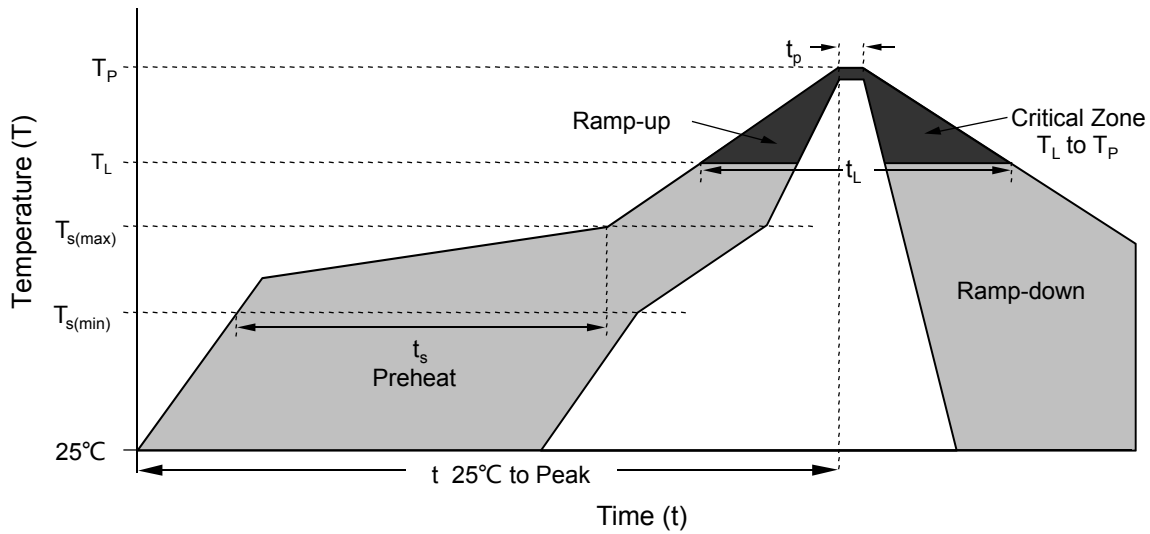
Fig.3 - t_r/t_d us Pulse Waveform

Fig.4 - VI Curve

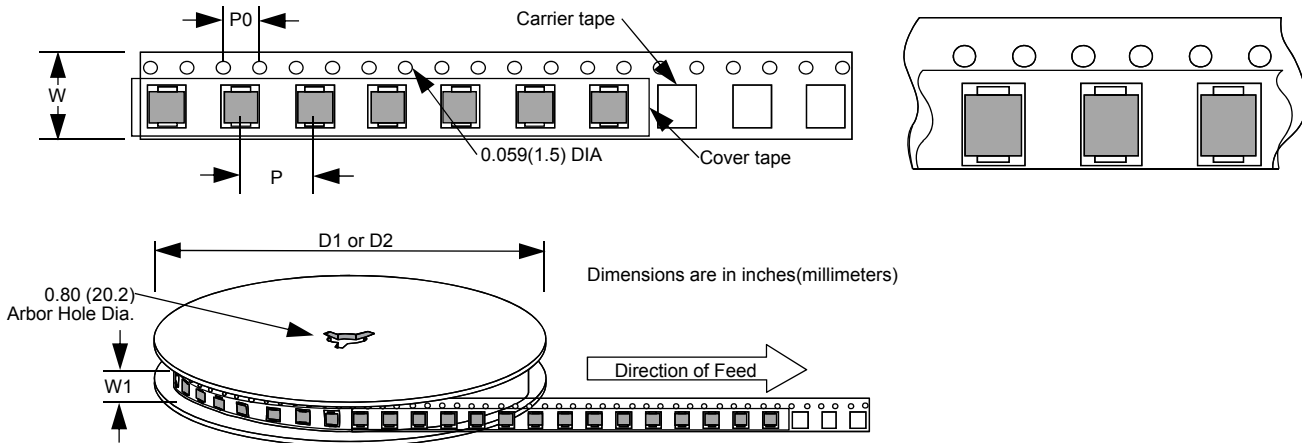
Fig.5 - Peak Pulse Current Rating

Fig.6 - Typical Off-state Capacitance



SMA						
Dimension	Inches			Millimeters		
	MIN	NOM	MAX	MIN	NOM	MAX
A	0.1	0.105	0.11	2.54	2.67	2.8
B	0.194	0.209	0.223	4.93	5.3	5.66
C	0.051		0.067	1.3		1.7
D	0.157		0.177	3.99		4.5
L	0.03		0.06	0.76		1.52
F	0.006		0.012	0.152		0.305
G	-		0.008	-		0.203
H	0.078	0.087	0.095	1.98	2.2	2.42
X		0.085			2.16	
Y		0.07			1.78	
Z		0.079			2	



Reflow Condition		Lead-free assembly
Pre Heat	- Temperature Min ($T_{s(min)}$)	150°C
	- Temperature Max ($T_{s(max)}$)	200°C
	- Time (min to max) (t_s)	60 – 180 secs
Average ramp up rate (Liquidus Temp (T_L) to peak)		$3^\circ\text{C/second max}$
$T_{s(max)}$ to T_L - Ramp-up Rate		$3^\circ\text{C/second max}$
Reflow	- Temperature (T_L) (Liquidus)	217°C
	- Time (t_L)	60 – 150 secs
Peak Temperature (T_P)		$260^{+0/-5^\circ\text{C}}$
Time within 5°C of actual peak Temperature (t_p)		20 – 40 secs
Ramp-down Rate		$6^\circ\text{C/second max}$
Time 25°C to peak Temperature (t)		8 minutes Max.
Do not exceed		260°C

Tape and Reel Specification

Dimension	Inches			Millimeters		
	MIN	NOM	MAX	MIN	NOM	MAX
P		0.157			4	
P0		0.157			4	
W		0.472			12	
W1		0.492			12.5	
D1		7			177.8	
D2		11			279.4	

Disclaimer
Disclaimer

This document is for reference only, data sheet specifications and its information contained are intended to provide a product description only. Yfsemi Microelectronics Stock Co., Ltd. reserves the right to make changes without notice for the specification of the products displayed herein to improve reliability, function or design or otherwise.

The product listed herein is designed to be used with ordinary electronic equipment or devices, and not designed to be used with equipment or devices which require high level of reliability and the malfunction of with would directly endanger human life (such as medical instruments, transportation equipment, aerospace machinery, nuclear-reactor controllers, fuel controllers and other safety devices). Customers using or selling Yfsemi components for use in such applications do so at their own risk and shall agree to fully indemnify Yfsemi and its subsidiaries harmless against all claims, damages and expenditures.

For additional information, please visit our website <http://www.yfsemi.com>