

# SF31 THRU SF38

## List

List..... 1

Package outline..... 2

Features..... 2

Mechanical data..... 2

Maximum ratings ..... 2

Rating and characteristic curves..... 3

Pinning information..... 4

Marking..... 4

Taping & bulk specifications for AXIAL devices..... 4

Suggested thermal profiles for soldering processes..... 5

High reliability test capabilities..... 6

深圳FMS Kinter 131 6803 0058

# SF31 THRU SF38

## 3.0A Axial Leaded Super Fast Rectifiers-50-600V

### Features

- Axial lead type devices for through hole design
- High current capability.
- Superfast recovery time for switching mode application,
- High surge capability.
- Silicon rubber coating chip junction.
- Lead-free parts meet RoHS requirements.
- Suffix "-H" indicates Halogen free parts, ex. SF31-H.

### Mechanical data

- Epoxy : UL94-V0 rated flame retardant
- Case : Molded plastic, DO-201AD
- Lead : Axial leads, solderable per MIL-STD-202, Method 208 guaranteed
- Polarity: Color band denotes cathode end
- Mounting Position : Any
- Weight : Approximated 1.10 gram

### Package outline

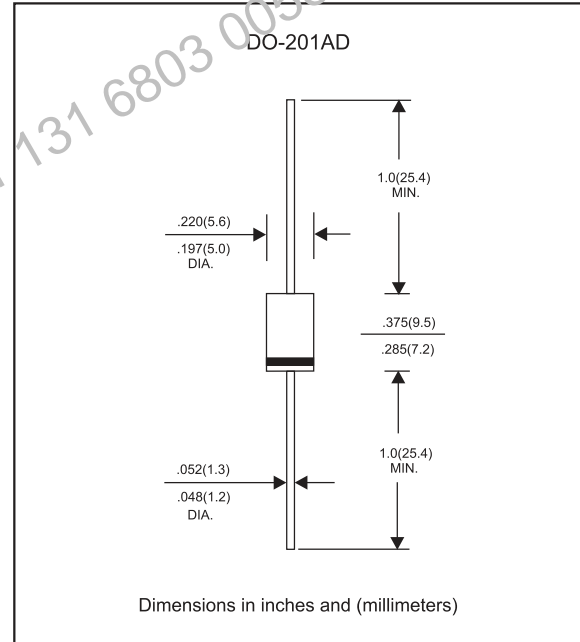

### Maximum ratings and Electrical Characteristics (AT T<sub>A</sub>=25°C unless otherwise noted)

PARAMETER	CONDITIONS	Symbol	MIN.	TYP.	MAX.	UNIT
Forward rectified current	Ambient temperature = 55°C	I <sub>O</sub>			3.0	A
Forward surge current	8.3ms single half sine-wave superimposed on rate load (JEDEC methode)	I <sub>FSM</sub>			125	A
Reverse current	V <sub>R</sub> = V <sub>RRM</sub> T <sub>J</sub> = 25°C	I <sub>R</sub>			5.0	μA
	V <sub>R</sub> = V <sub>RRM</sub> T <sub>J</sub> = 100°C				100	
Diode junction capacitance	f=1MHz and applied 4V DC reverse voltage	C <sub>J</sub>		50		pF
Storage temperature		T <sub>STG</sub>	-65		+175	°C

SYMBOLS	V <sub>RRM</sub> *1 (V)	V <sub>RMS</sub> *2 (V)	V <sub>R</sub> *3 (V)	V <sub>F</sub> *4 (V)	t <sub>rr</sub> *5 (ns)	Operating temperature T <sub>J</sub> , (°C)
SF31	50	35	50	0.95	35	-55 to +125
SF32	100	70	100			
SF33	150	105	150			
SF34	200	140	200			
SF35	300	210	300	1.25		
SF36	400	280	400	1.70		
SF37	500	350	500			
SF38	600	420	600			

- \*1 Repetitive peak reverse voltage
- \*2 RMS voltage
- \*3 Continuous reverse voltage
- \*4 Maximum forward voltage@I<sub>F</sub>=3.0A
- \*5 Maximum Reverse recovery time, note 1

Note 1. Reverse recovery time test condition, I<sub>F</sub>=0.5A, I<sub>R</sub>=1.0A, I<sub>RR</sub>=0.25A

## Rating and characteristic curves (SF31 THRU SF38)

FIG.1- TEST CIRCUIT DIAGRAM AND REVERSE RECOVERY TIME CHARACTERISTIC

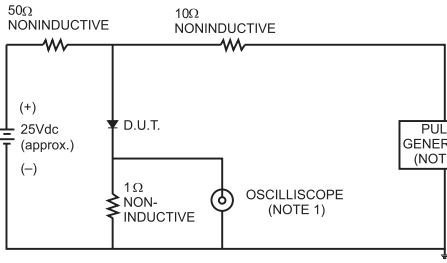

NOTES: 1. Rise Time= 7ns max., Input Impedance= 1 megohm.22pF.  
2. Rise Time= 10ns max., Source Impedance= 50 ohms.

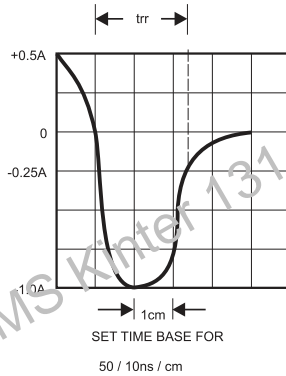

FIG.2-TYPICAL FORWARD CURRENT DERATING CURVE

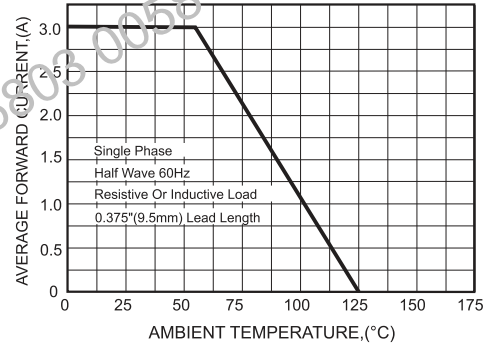

FIG.3-TYPICAL FORWARD CHARACTERISTICS

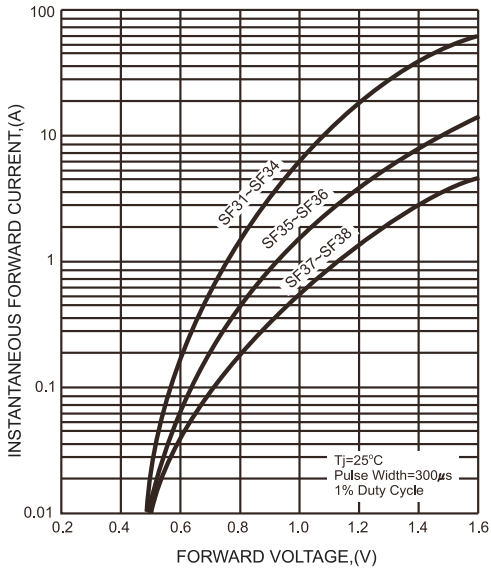

FIG.4-TYPICAL REVERSE CHARACTERISTICS

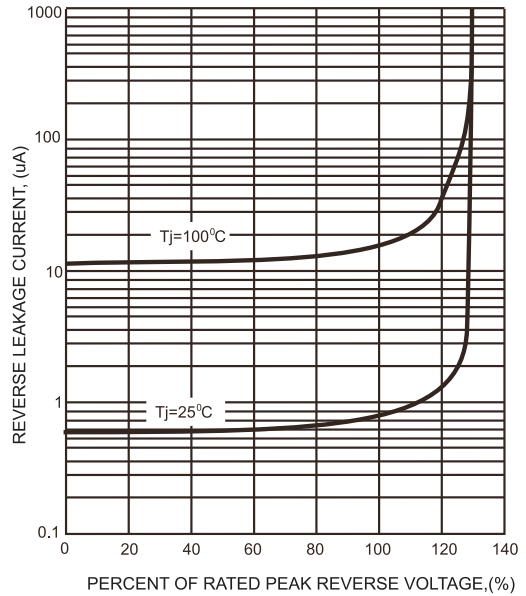

FIG.5-MAXIMUM NON-REPETITIVE FORWARD SURGE CURRENT

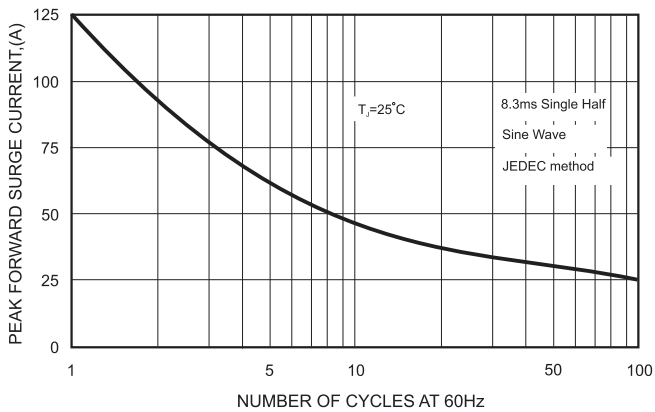
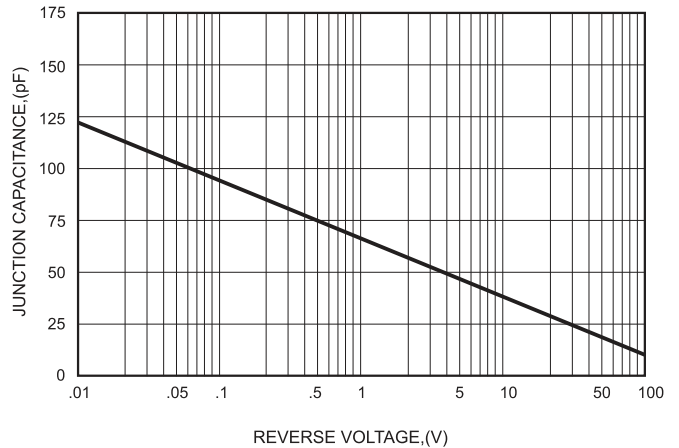



FIG.6-TYPICAL JUNCTION CAPACITANCE



# SF31 THRU SF38

## Pinning information

Pin	Simplified outline	Symbol
Pin1 cathode Pin2 anode		

## Marking

Type number	Marking code
SF31	SF31
SF32	SF32
SF33	SF33
SF34	SF34
SF35	SF35
SF36	SF36
SF37	SF37
SF38	SF38

## Taping & bulk specifications for AXIAL devices

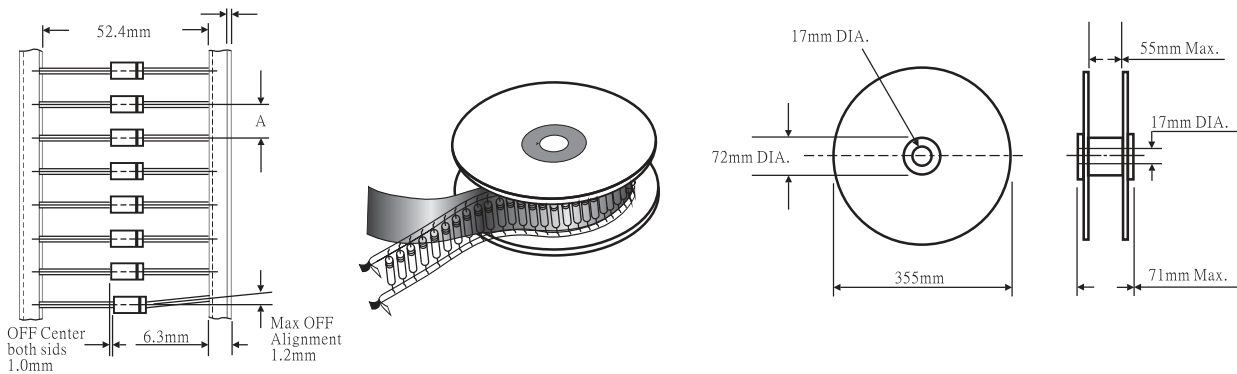

### REEL PACKING

DEVICE CASE TYPE	Q'TY 1 (PCS / REEL)	COMPONENT SPACING "A" in FIG. A	CARTON SIZE (m/m)	Q'TY 2 (PCS / CARTON)	APPROX. CROSS WEIGHT(kg)
DO-201AD	1,200	10 mm	380 * 340 * 370	4,800	9.1

### AMMO PACKING

DEVICE CASE TYPE	Q'TY 1 (PCS / BOX)	INNER BOX SIZE (m/m)	CARTON SIZE (m/m)	Q'TY 2 (PCS / CARTON)	APPROX. CROSS WEIGHT(kg)
DO-201AD	1,200	260 * 83 * 160	440 * 270 * 340	12,000	17.0

# SF31 THRU SF38

BULK PACKING

DEVICE CASE TYPE	Q'TY 1 (PCS / BOX)	INNER BOX SIZE (m/m)	CARTON SIZE (m/m)	Q'TY 2 (PCS / CARTON)	APPROX. CROSS WEIGHT(kg)
DO-201AD	500	305 * 73 * 40	347 * 320 * 271	12,000	16.4

Suggested thermal profiles for soldering processes

1. Lead free temperature profile wave-soldering

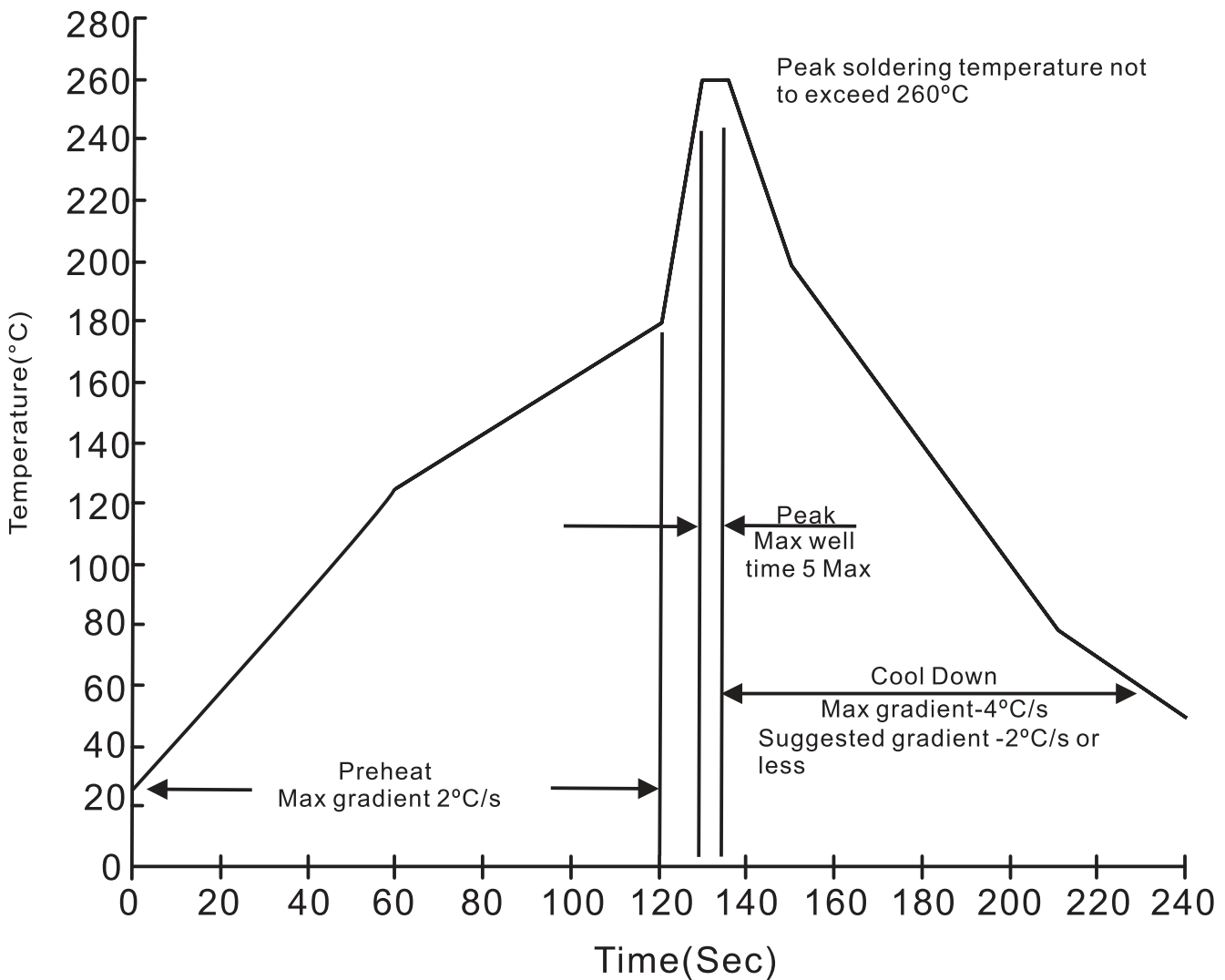

**SF31 THRU SF38****High reliability test capabilities**

Item Test	Conditions	Reference
1. Solder Resistance	at $260 \pm 5^\circ\text{C}$ for $10 \pm 2$ sec. immerse body into solder $1/16" \pm 1/32"$	MIL-STD-750D METHOD-2031
2. Solderability	at $245 \pm 5^\circ\text{C}$ for 5 sec.	MIL-STD-202F METHOD-208
3. Pull Test	2.0kg in axial lead direction for 10 sec. $I_F = I_O$	MIL-STD-202F METHOD-211A
4. Bend Lead	2.0kg weight applied to each lead bending arc $90^\circ \pm 5^\circ$ for 3 times, $I_F = I_O$	MIL-STD-202F METHOD-211A
5. High Temperature Reverse Bias	$V_R = 80\%$ rate at $T_J = 125^\circ\text{C}$ for 168 hrs.	MIL-STD-750D METHOD-1038
6. Forward Operation Life	Rated average rectifier current at $T_A = 25^\circ\text{C}$ for 500hrs.	MIL-STD-750D METHOD-1027
7. Intermittent Operation Life	$T_A = 25^\circ\text{C}$ , $I_F = I_O$ On state: power on for 5 min. off state: power off for 5 min, on and off for 500 cycles.	MIL-STD-750D METHOD-1036
8. Pressure Cooker	$15P_{SIG}$ at $T_A = 121^\circ\text{C}$ for 4 hrs.	JESD22-A102
9. Temperature Cycling	$-55^\circ\text{C}$ to $+125^\circ\text{C}$ dwelled for 30 min. and transferred for 5min. total 10 cycles.	MIL-STD-750D METHOD-1051
10. Thermal Shock	$0^\circ\text{C}$ for 5 min. rise to $100^\circ\text{C}$ for 5 min. total 10 cycles.	MIL-STD-750D METHOD-1056
11. Forward Surge	8.3ms single half sine-wave superimposed on rated load, one surge.	MIL-STD-750D METHOD-4066-2
12. Humidity	at $T_A = 85^\circ\text{C}$ , RH=85% for 1000hrs.	MIL-STD-750D METHOD-1021
13. High Temperature Storage Life	at $175^\circ\text{C}$ for 1000 hrs.	MIL-STD-750D METHOD-1031