

Applications

- Synchronous MOSFET for Notebook Processor Power
- Secondary Synchronous Rectification for Isolated DC-DC Converters
- Synchronous Fet for Non-Isolated DC-DC Converters
- Lead-Free

Benefits

- Very Low $R_{DS(on)}$ at 4.5V V_{GS}
- Low Gate Charge
- Fully Characterized Avalanche Voltage and Current

HEXFET® Power MOSFET

V_{DSS}	$R_{DS(on)}$ max	Q_g (typ.)
40V	5.0m Ω @ $V_{GS} = 10V$	33nC

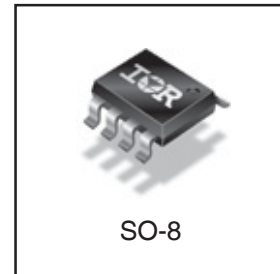
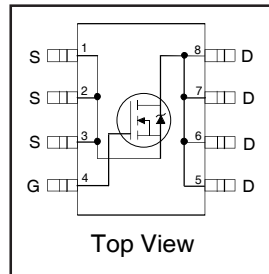

Base Part Number	Package Type	Standard Pack		Orderable Part Number
		Form	Quantity	
IRF7842PbF	SO-8	Tube/Bulk	95	IRF7842PbF
		Tape and Reel	4000	IRF7842TRPbF

Absolute Maximum Ratings

	Parameter	Max.	Units
V_{DS}	Drain-to-Source Voltage	40	V
V_{GS}	Gate-to-Source Voltage	± 20	
I_D @ $T_A = 25^\circ C$	Continuous Drain Current, V_{GS} @ 10V	18	A
I_D @ $T_A = 70^\circ C$	Continuous Drain Current, V_{GS} @ 10V	14	
I_{DM}	Pulsed Drain Current ①	140	
P_D @ $T_A = 25^\circ C$	Power Dissipation ④	2.5	W
P_D @ $T_A = 70^\circ C$	Power Dissipation ④	1.6	
	Linear Derating Factor	0.02	W/ $^\circ C$
T_J	Operating Junction and	-55 to + 150	$^\circ C$
T_{STG}	Storage Temperature Range		

Thermal Resistance

	Parameter	Typ.	Max.	Units
$R_{\theta JL}$	Junction-to-Drain Lead ⑤	—	20	$^\circ C/W$
$R_{\theta JA}$	Junction-to-Ambient ④⑤	—	50	

Notes ① through ⑤ are on page 10

Static @ T_J = 25°C (unless otherwise specified)

	Parameter	Min.	Typ.	Max.	Units	Conditions
BV _{DSS}	Drain-to-Source Breakdown Voltage	40	—	—	V	V _{GS} = 0V, I _D = 250μA
ΔBV _{DSS} /ΔT _J	Breakdown Voltage Temp. Coefficient	—	0.037	—	V/°C	Reference to 25°C, I _D = 1mA
R _{DS(on)}	Static Drain-to-Source On-Resistance	—	4.0	5.0	mΩ	V _{GS} = 10V, I _D = 17A ③
		—	4.7	5.9		V _{GS} = 4.5V, I _D = 14A ③
V _{GS(th)}	Gate Threshold Voltage	1.35	—	2.25	V	V _{DS} = V _{GS} , I _D = 250μA
ΔV _{GS(th)}	Gate Threshold Voltage Coefficient	—	- 5.6	—	mV/°C	
I _{DSS}	Drain-to-Source Leakage Current	—	—	1.0	μA	V _{DS} = 32V, V _{GS} = 0V
		—	—	150		V _{DS} = 32V, V _{GS} = 0V, T _J = 125°C
I _{GSS}	Gate-to-Source Forward Leakage	—	—	100	nA	V _{GS} = 20V
	Gate-to-Source Reverse Leakage	—	—	-100		V _{GS} = -20V
g _{fs}	Forward Transconductance	81	—	—	S	V _{DS} = 20V, I _D = 14A
Q _g	Total Gate Charge	—	33	50	nC	V _{DS} = 20V V _{GS} = 4.5V I _D = 14A
Q _{gs1}	Pre-V _{th} Gate-to-Source Charge	—	9.6	—		
Q _{gs2}	Post-V _{th} Gate-to-Source Charge	—	2.8	—		
Q _{gd}	Gate-to-Drain Charge	—	10	—		
Q _{godr}	Gate Charge Overdrive	—	10.6	—		
Q _{sw}	Switch Charge (Q _{gs2} + Q _{gd})	—	12.8	—		
Q _{oss}	Output Charge	—	18	—	nC	V _{DS} = 16V, V _{GS} = 0V
R _G	Gate Resistance	—	1.3	2.6	Ω	
t _{d(on)}	Turn-On Delay Time	—	14	—	ns	V _{DD} = 20V, V _{GS} = 4.5V ③ I _D = 14A Clamped Inductive Load
t _r	Rise Time	—	12	—		
t _{d(off)}	Turn-Off Delay Time	—	21	—		
t _f	Fall Time	—	5.0	—		
C _{iss}	Input Capacitance	—	4500	—	pF	V _{GS} = 0V V _{DS} = 20V f = 1.0MHz
C _{oss}	Output Capacitance	—	680	—		
C _{rss}	Reverse Transfer Capacitance	—	310	—		

Avalanche Characteristics

	Parameter	Typ.	Max.	Units
E _{AS}	Single Pulse Avalanche Energy ②	—	50	mJ
I _{AR}	Avalanche Current ①	—	14	A

Diode Characteristics

	Parameter	Min.	Typ.	Max.	Units	Conditions
I _S	Continuous Source Current (Body Diode)	—	—	3.1	A	MOSFET symbol showing the integral reverse p-n junction diode. 
I _{SM}	Pulsed Source Current (Body Diode) ①	—	—	140		
V _{SD}	Diode Forward Voltage	—	—	1.0	V	T _J = 25°C, I _S = 14A, V _{GS} = 0V ③
t _{rr}	Reverse Recovery Time	—	99	150	ns	T _J = 25°C, I _F = 14A, V _{DD} = 20V
Q _{rr}	Reverse Recovery Charge	—	11	17	nC	di/dt = 100A/μs ③

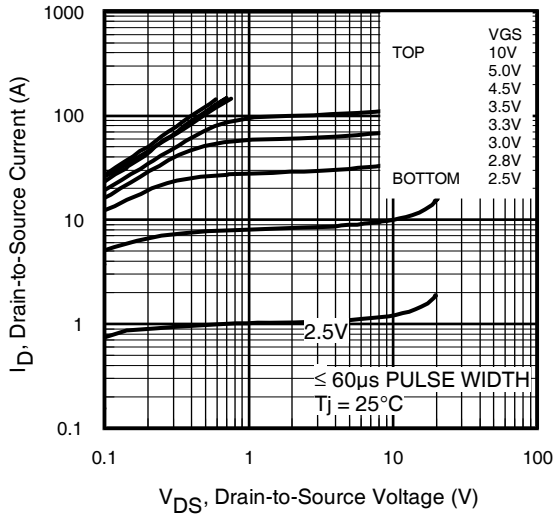
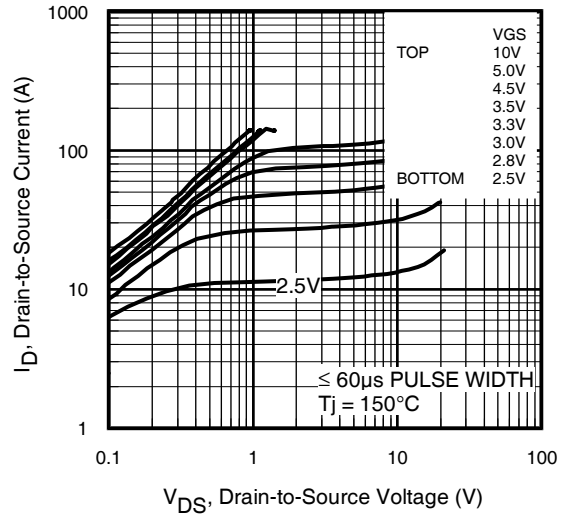
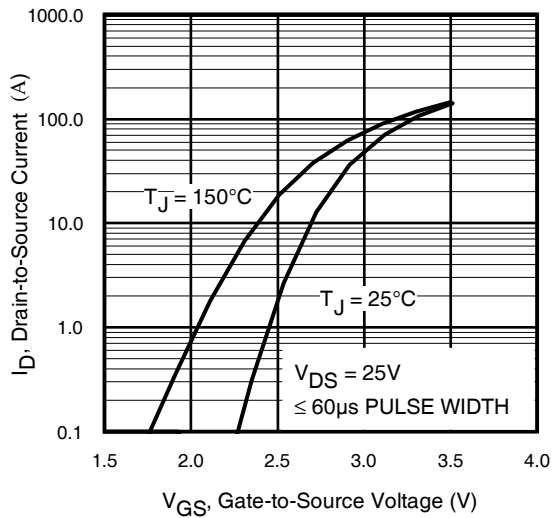
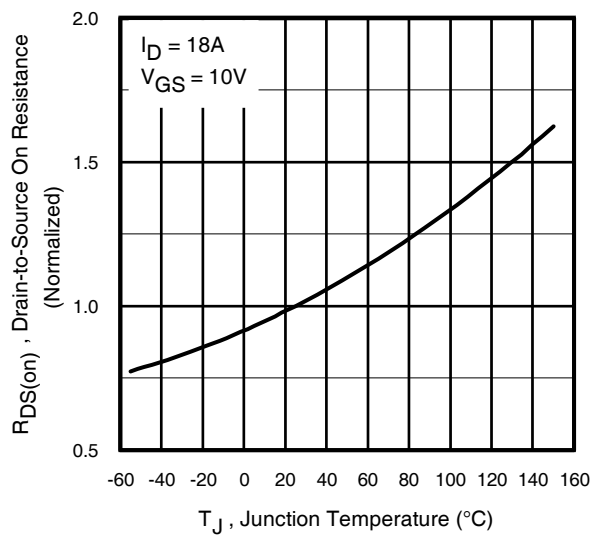
Fig 1. Typical Output Characteristics

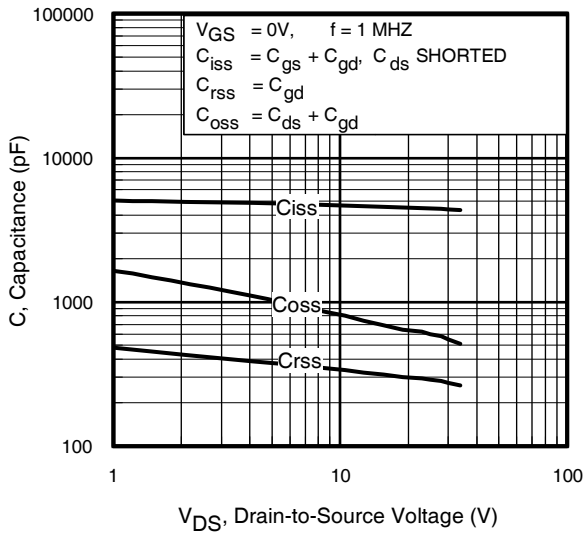
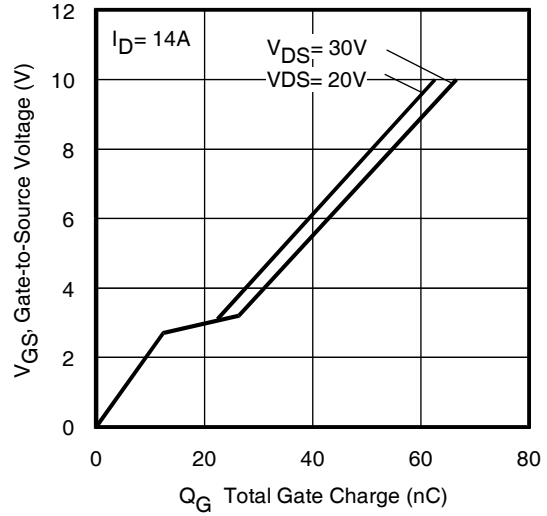
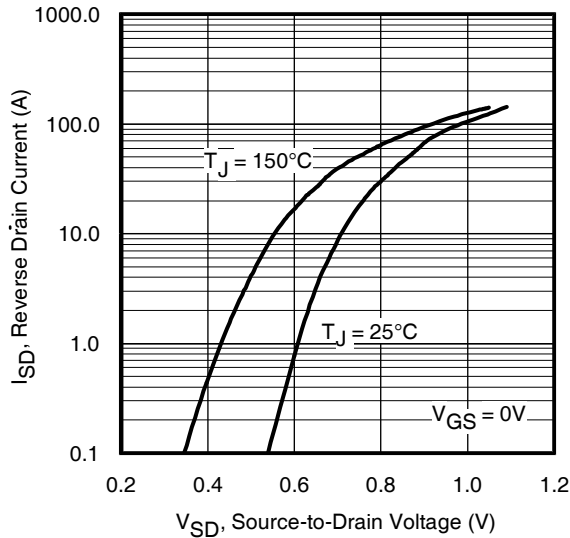
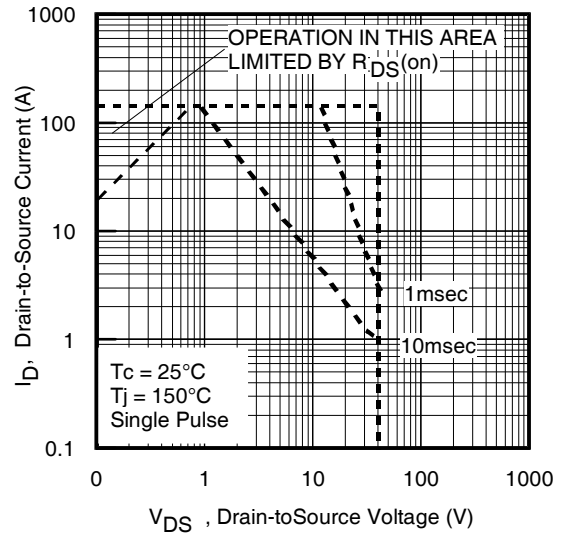
Fig 2. Typical Output Characteristics

Fig 3. Typical Transfer Characteristics

Fig 4. Normalized On-Resistance Vs. Temperature

Fig 5. Typical Capacitance Vs. Drain-to-Source Voltage

Fig 6. Typical Gate Charge Vs. Gate-to-Source Voltage

Fig 7. Typical Source-Drain Diode Forward Voltage

Fig 8. Maximum Safe Operating Area

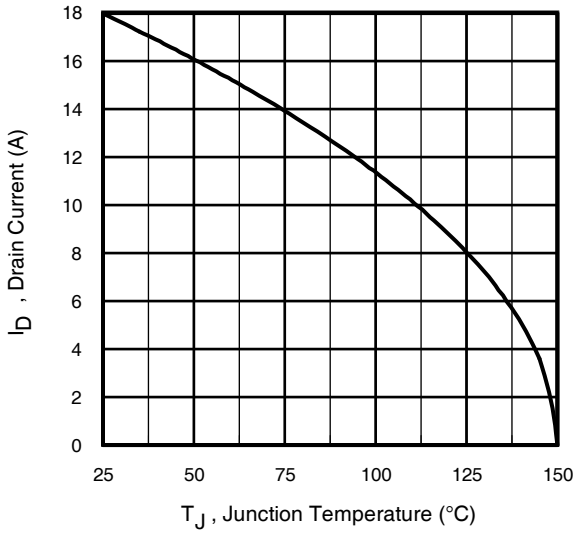

Fig 9. Maximum Drain Current Vs. Case Temperature

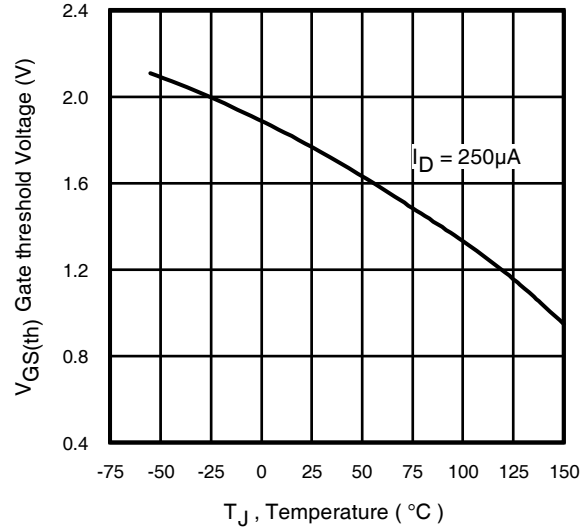

Fig 10. Threshold Voltage Vs. Temperature

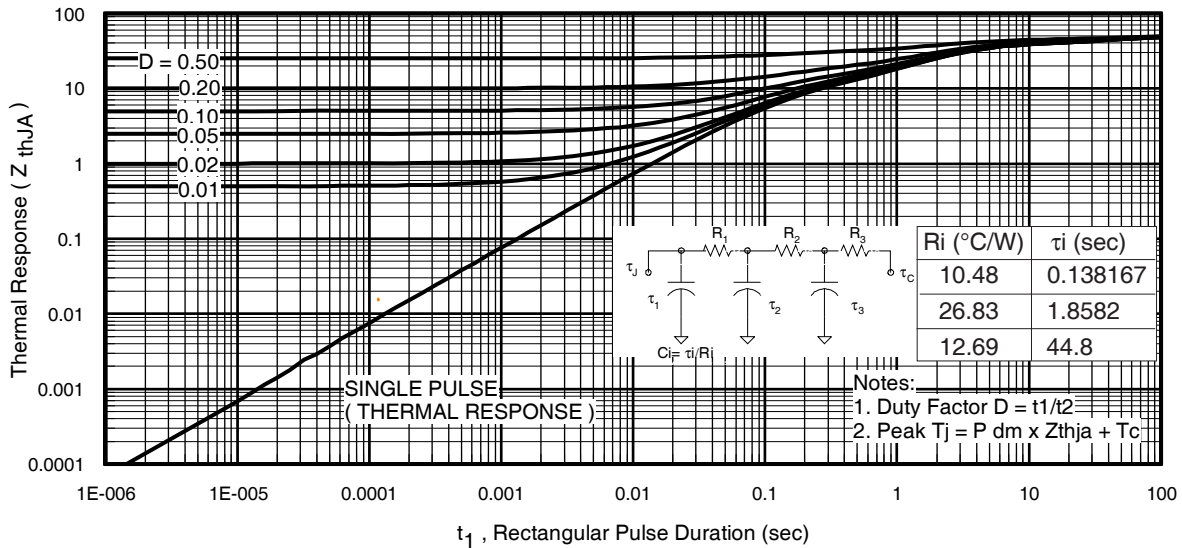
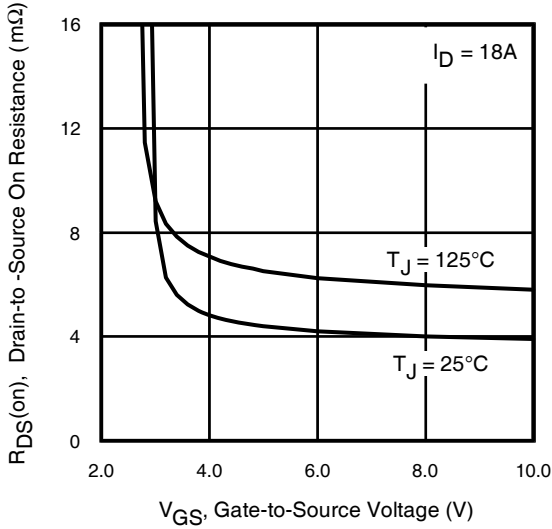
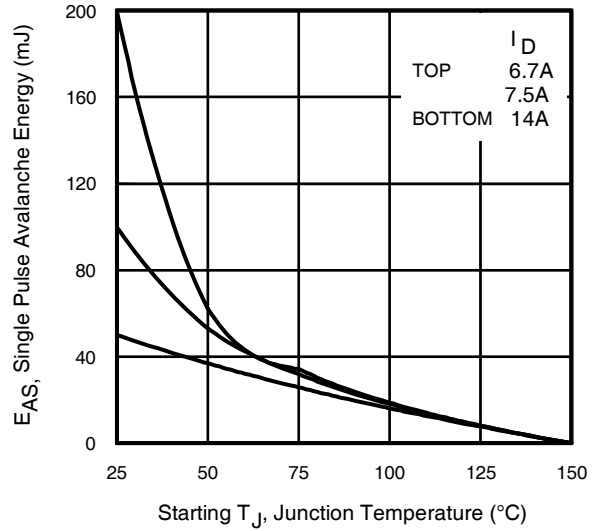
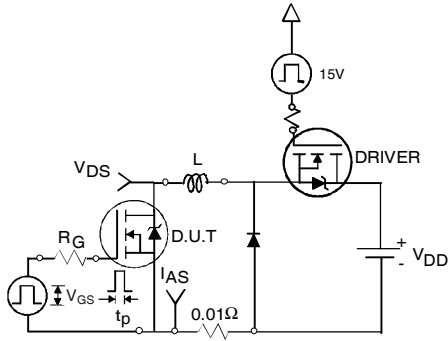
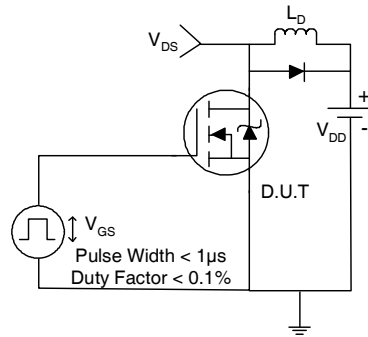
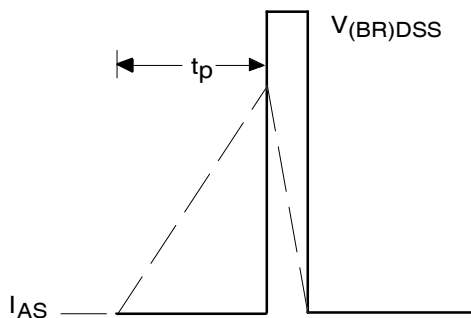
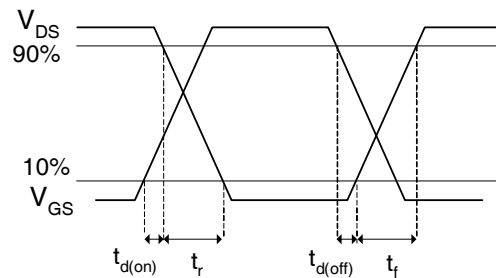

Fig 11. Maximum Effective Transient Thermal Impedance, Junction-to-Ambient

Fig 12. On-Resistance Vs. Gate Voltage

Fig 13c. Maximum Avalanche Energy Vs. Drain Current

Fig 13a. Unclamped Inductive Test Circuit

Fig 14a. Switching Time Test Circuit

Fig 13b. Unclamped Inductive Waveforms

Fig 14b. Switching Time Waveforms

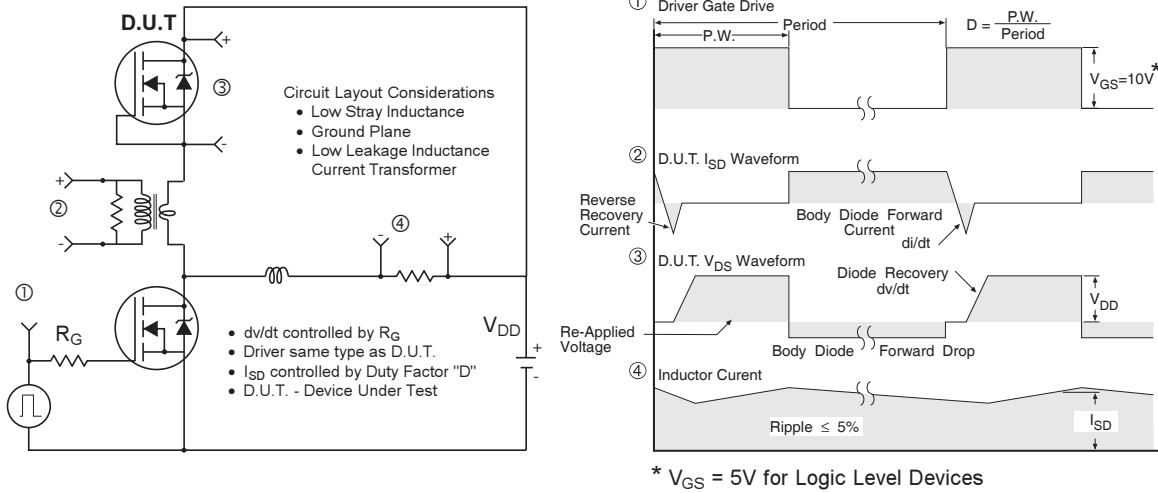

Fig 15. Peak Diode Recovery dv/dt Test Circuit for N-Channel HEXFET® Power MOSFETS

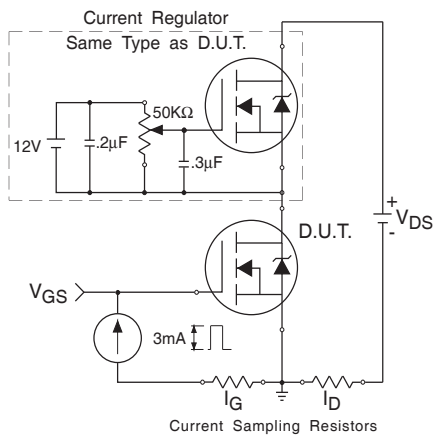

Fig 16. Gate Charge Test Circuit

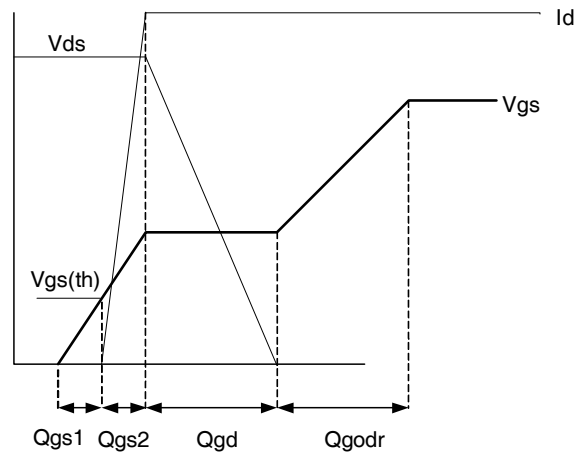
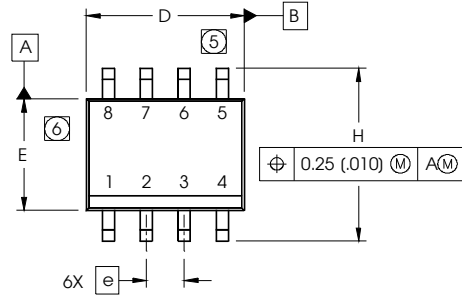

Fig 17. Gate Charge Waveform

SO-8 Package Outline

Dimensions are shown in millimeters (inches)



DIM	INCHES		MILLIMETERS	
	MIN	MAX	MIN	MAX
A	.0532	.0688	1.35	1.75
A1	.0040	.0098	0.10	0.25
b	.013	.020	0.33	0.51
c	.0075	.0098	0.19	0.25
D	.189	.1968	4.80	5.00
E	.1497	.1574	3.80	4.00
e	.050 BASIC		1.27 BASIC	
e1	.025 BASIC		0.635 BASIC	
H	.2284	.2440	5.80	6.20
K	.0099	.0196	0.25	0.50
L	.016	.050	0.40	1.27
y	0°	8°	0°	8°

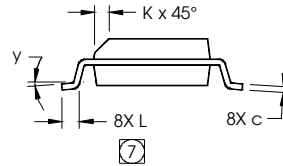
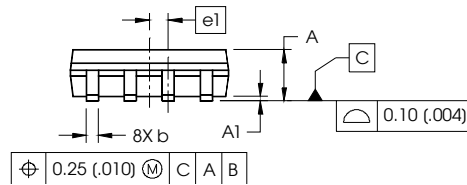

NOTES:

1. DIMENSIONING & TOLERANCING PER ASME Y14.5M-1994.
2. CONTROLLING DIMENSION: MILLIMETER
3. DIMENSIONS ARE SHOWN IN MILLIMETERS (INCHES).
4. OUTLINE CONFORMS TO JEDEC OUTLINE MS-012AA
- ⑤ DIMENSION DOES NOT INCLUDE MOLD PROTRUSIONS. MOLD PROTRUSIONS NOT TO EXCEED 0.15 (.006).
- ⑥ DIMENSION DOES NOT INCLUDE MOLD PROTRUSIONS. MOLD PROTRUSIONS NOT TO EXCEED 0.25 (.010).
- ⑦ DIMENSION IS THE LENGTH OF LEAD FOR SOLDERING TO A SUBSTRATE.

FOOTPRINT

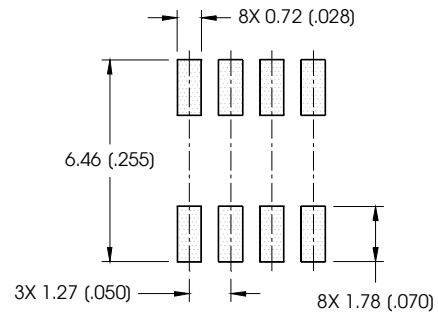

SO-8 Part Marking

EXAMPLE: THIS IS AN IRF7101 (MOSFET)

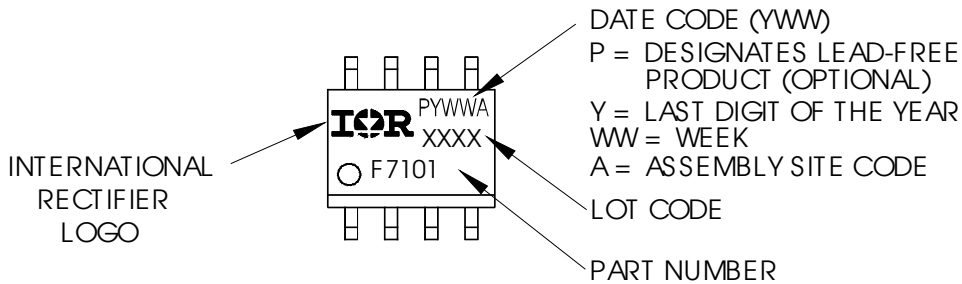

Note: For the most current drawing please refer to IR website at: <http://www.irf.com/package/>

SO-8 Tape and Reel

Dimensions are shown in millimeters (inches)

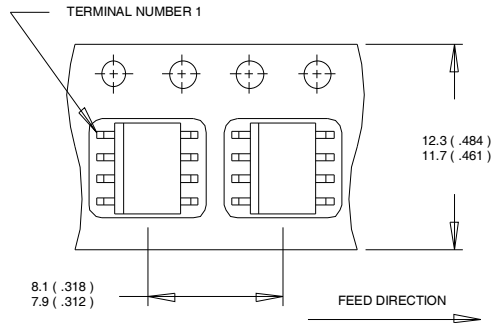

- NOTES:
1. CONTROLLING DIMENSION : MILLIMETER.
 2. ALL DIMENSIONS ARE SHOWN IN MILLIMETERS(INCHES).
 3. OUTLINE CONFORMS TO EIA-481 & EIA-541.

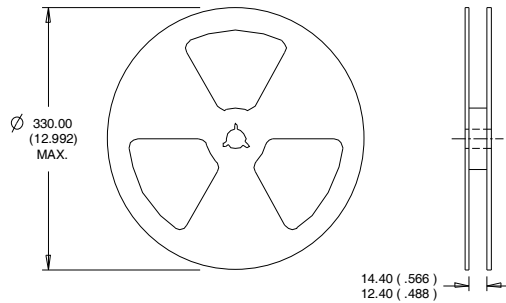

- NOTES:
1. CONTROLLING DIMENSION : MILLIMETER.
 2. OUTLINE CONFORMS TO EIA-481 & EIA-541.

Note: For the most current drawing please refer to IR website at: <http://www.irf.com/package/>

Qualification information[†]

Qualification level	Consumer (per JEDEC JESD47F ^{††} guidelines)	
Moisture Sensitivity Level	SO-8	MSL1 (per JEDEC J-STD-020D ^{††})
RoHS compliant	Yes	

[†] Qualification standards can be found at International Rectifier's web site: <http://www.irf.com/product-info/reliability>

^{††} Applicable version of JEDEC standard at the time of product release

Notes:

- ① Repetitive rating; pulse width limited by max. junction temperature.
- ② Starting $T_J = 25^\circ\text{C}$, $L = 0.5\text{mH}$
 $R_G = 25\Omega$, $I_{AS} = 14\text{A}$.
- ③ Pulse width $\leq 400\mu\text{s}$; duty cycle $\leq 2\%$.
- ④ When mounted on 1 inch square copper board
- ⑤ R_θ is measured at T_J approximately 90°C

Revision History

Date	Comment
7/8/2014	<ul style="list-style-type: none"> • Updated data sheet based on corporate template. • Added Qual level on page10. • Added ordering information on page1 • Updated Max RG from "TBD" to "2.6Ohm" on page2.