

**Features**

- Output Current of 1.5A
- Thermal Overload Protection
- Short Circuit Protection
- Output transistor safe area protection
- No external components
- Package: TO220
- Output voltage accuracy: tolerance  $\pm 2\%$

**General Description**

HE78XX is three-terminal positive regulators. One of these regulators can deliver up to 1.5A of output current. The internal limiting and thermal-shutdown features of the regulator make them essentially immune to overload. When used as a

replacement for a zener diode-resistor Combination, an effective improvement in output impedance can be obtained, together with lower quiescent current.

**Pin Configuration**

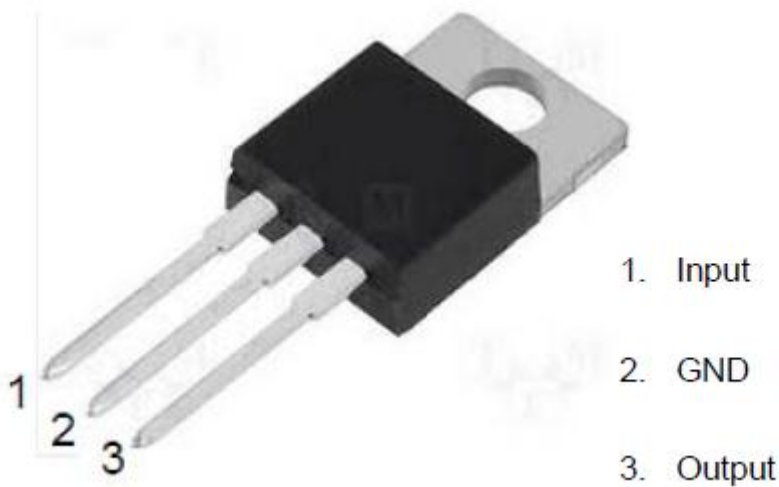

### Selection Table

Part No.	Output Voltage	Package	Marking
HE7805	5.0V	TO220	
HE7806	6.0V		
HE7808	8.0V		
HE7809	9.0V		
HE7812	12V		

### Block Diagram

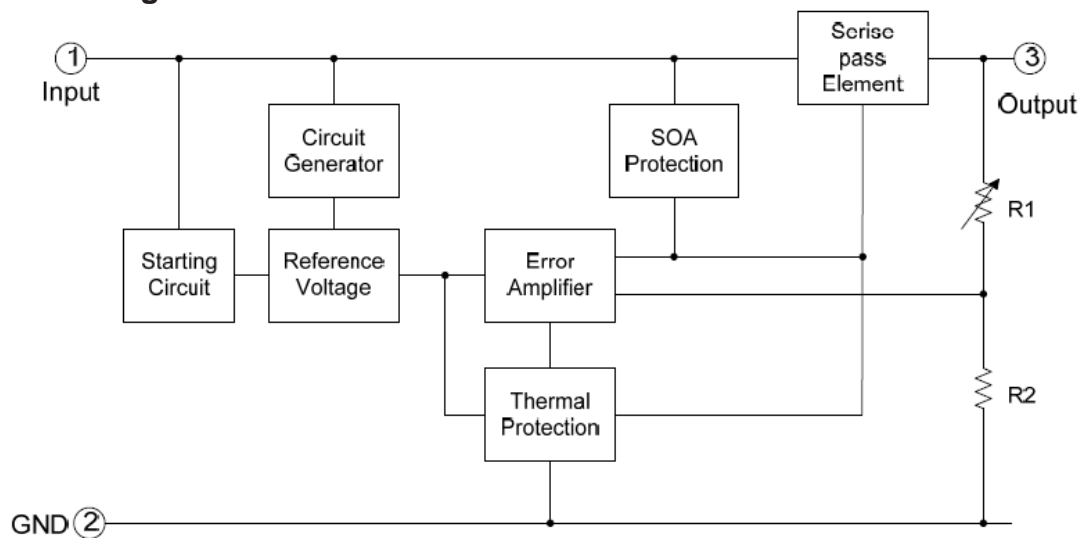

### Absolute Maximum Ratings (Ta=25°C)

Parameter	Rating	Unit
Input supply voltage: VIN	35	V
MAX. Output current: Iout	1500	mA
Maximum junction temperature: Tj	-25~125	°C
Storage temperature: Tstr	-65~125	°C
Soldering temperature and time	+260(Recommended 10S)	°C

Note: The absolute maximum ratings are rated values exceeding which the product could suffer physical damage. These values must therefore not be exceeded under any conditions.

**Electrical Characteristics**

1、HE7805 (refer to the test circuits,  $T_J = -55$  to  $150^\circ\text{C}$   $V_I = 10\text{V}$   $I_O = 500\text{mA}$ ,  $C_I = 0.33\ \mu\text{F}$ ,  $C_O = 0.1\ \mu\text{F}$  unless otherwise specified)。

Parameter	Symbol	Test Condition	MIN	TYP	MAX	UNIT
Output Voltage	VO	$T_J = +25^\circ\text{C}$	4.9	5	5.1	V
		$I_O = 5\text{mA}$ to $1\text{A}$ , $P_O \leq 15\text{W}$ $V_I = 8\text{V}$ to $20\text{V}$	4.9	5	5.1	
Line Regulation (Note1)	$\Delta V_O$	$T_J = +25^\circ\text{C}$	$V_I = 7\text{V}$ to $25\text{V}$		100	mV
			$V_I = 8\text{V}$ to $12\text{V}$		50	
Load Regulation (Note1)	$\Delta V_O$	$T_J = +25^\circ\text{C}$ , $I_O = 5\text{mA}$ to $1.5\text{A}$			100	mV
		$T_J = +25^\circ\text{C}$ , $I_O = 250\text{mA}$ to $750\text{mA}$			50	
Quiescent Current	IQ	$T_J = +25^\circ\text{C}$			6	mA
Quiescent Current Change	$\Delta I_Q$	$I_O = 5\text{mA}$ to $1\text{A}$			0.5	mA
		$V_I = 8\text{V}$ to $25\text{V}$			0.8	
Quiescent Current Change	$\Delta V_O / \Delta T$	$I_O = 5\text{mA}$		0.6		mV/ $^\circ\text{C}$
Short Circuit Current	ISC	$T_J = +25^\circ\text{C}$ , $V_I = 35\text{V}$		0.75	1.2	A

2、HE7806 (refer to the test circuits,  $T_J = -55$  to  $150^\circ\text{C}$   $V_I = 11\text{V}$   $I_O = 500\text{mA}$ ,  $C_I = 0.33\ \mu\text{F}$ ,  $C_O = 0.1\ \mu\text{F}$  unless otherwise specified)。

Parameter	Symbol	Test Condition	MIN	TYP	MAX	UNIT
Output Voltage	VO	$T_J = +25^\circ\text{C}$	5.88	6	6.12	V
		$I_O = 5\text{mA}$ to $1\text{A}$ , $P_O \leq 15\text{W}$ $V_I = 9\text{V}$ to $21\text{V}$	5.88	6	6.12	
Line Regulation (Note1)	$\Delta V_O$	$T_J = +25^\circ\text{C}$	$V_I = 8\text{V}$ to $25\text{V}$		100	mV
			$V_I = 9\text{V}$ to $13\text{V}$		50	
Load Regulation (Note1)	$\Delta V_O$	$T_J = +25^\circ\text{C}$ , $I_O = 5\text{mA}$ to $1.5\text{A}$			100	mV
		$T_J = +25^\circ\text{C}$ , $I_O = 250\text{mA}$ to $750\text{mA}$			50	
Quiescent Current	IQ	$T_J = +25^\circ\text{C}$			6	mA
Quiescent Current Change	$\Delta I_Q$	$I_O = 5\text{mA}$ to $1\text{A}$			0.5	mA
		$V_I = 9\text{V}$ to $25\text{V}$			0.8	
Quiescent Current Change	$\Delta V_O / \Delta T$	$I_O = 5\text{mA}$		0.7		mV/ $^\circ\text{C}$
Short Circuit Current	ISC	$T_J = +25^\circ\text{C}$ , $V_I = 35\text{V}$		0.75	1.2	A

3、HE7808 (refer to the test circuits,  $T_J = -55$  to  $150^{\circ}\text{C}$   $V_I = 14\text{V}$   $I_O = 500\text{ mA}$ ,  $C_I = 0.33\ \mu\text{F}$ ,  $C_O = 0.1\ \mu\text{F}$  unless otherwise specified)。

Parameter	Symbol	Test Condition	MIN	TYP	MAX	UNIT
Output Voltage	VO	$T_J = +25^{\circ}\text{C}$	7.84	8	8.16	V
		$I_O = 5\text{mA to } 1\text{A}$ , $P_O \leq 15\text{W}$ $V_I = 11.5\text{V to } 23\text{V}$	7.84	8	8.16	
Line Regulation (Note1)	$\Delta V_O$	$T_J = +25^{\circ}\text{C}$	$V_I = 10.5\text{V to } 25\text{V}$		100	mV
			$V_I = 11\text{V to } 17\text{V}$		50	
Load Regulation (Note1)	$\Delta V_O$	$T_J = +25^{\circ}\text{C}$ , $I_O = 5\text{mA to } 1.5\text{A}$			100	mV
		$T_J = +25^{\circ}\text{C}$ , $I_O = 250\text{mA to } 750\text{mA}$			50	
Quiescent Current	IQ	$T_J = +25^{\circ}\text{C}$			6	mA
Quiescent Current Change	$\Delta I_Q$	$I_O = 5\text{mA to } 1\text{A}$			0.5	mA
		$V_I = 11.5\text{V to } 25\text{V}$			1	
Quiescent Current Change	$\Delta V_O / \Delta T$	$I_O = 5\text{mA}$		1		mV/ $^{\circ}\text{C}$
Short Circuit Current	ISC	$T_J = +25^{\circ}\text{C}$ , $V_I = 35\text{V}$		0.75	1.2	A

4、HE7809 (refer to the test circuits,  $T_J = -55$  to  $150^{\circ}\text{C}$   $V_I = 15\text{V}$   $I_O = 500\text{ mA}$ ,  $C_I = 0.33\ \mu\text{F}$ ,  $C_O = 0.1\ \mu\text{F}$  unless otherwise specified)。

Parameter	Symbol	Test Condition	MIN	TYP	MAX	UNIT
Output Voltage	VO	$T_J = +25^{\circ}\text{C}$	8.82	9	9.18	V
		$I_O = 5\text{mA to } 1\text{A}$ , $P_O \leq 15\text{W}$ $V_I = 11.5\text{V to } 26\text{V}$	8.82	9	9.18	
Line Regulation (Note1)	$\Delta V_O$	$T_J = +25^{\circ}\text{C}$	$V_I = 11.5\text{V to } 26\text{V}$		100	mV
			$V_I = 12\text{V to } 18\text{V}$		50	
Load Regulation (Note1)	$\Delta V_O$	$T_J = +25^{\circ}\text{C}$ , $I_O = 5\text{mA to } 1.5\text{A}$			100	mV
		$T_J = +25^{\circ}\text{C}$ , $I_O = 250\text{mA to } 750\text{mA}$			50	
Quiescent Current	IQ	$T_J = +25^{\circ}\text{C}$			6	mA
Quiescent Current Change	$\Delta I_Q$	$I_O = 5\text{mA to } 1\text{A}$			0.5	mA
		$V_I = 11.5\text{V to } 26\text{V}$			1	
Quiescent Current Change	$\Delta V_O / \Delta T$	$I_O = 5\text{mA}$		1		mV/ $^{\circ}\text{C}$
Short Circuit Current	ISC	$T_J = +25^{\circ}\text{C}$ , $V_I = 35\text{V}$		0.75	1.2	A

5、HE7812 (refer to the test circuits ,  $T_J = -55$  to  $150^{\circ}\text{C}$   $V_I = 19\text{V}$   $I_O = 500\text{ mA}$  ,  $C_I = 0.33\ \mu\text{F}$  ,  $C_O = 0.1\ \mu\text{F}$  unless otherwise specified)。

Parameter	Symbol	Test Condition	MIN	TYP	MAX	UNIT	
Output Voltage	VO	$T_J = +25^{\circ}\text{C}$	11.76	12	12.24	V	
		$I_O = 5\text{mA to } 1\text{A}$ , $P_O \leq 15\text{W}$ $V_I = 15.5\text{V to } 27\text{V}$	11.76	12	12.24		
Line Regulation (Note1)	$\Delta V_O$	$T_J = +25^{\circ}\text{C}$	$V_I = 14.5\text{V to } 30\text{V}$			100	mV
			$V_I = 16\text{V to } 22\text{V}$			50	
Load Regulation (Note1)	$\Delta V_O$	$T_J = +25^{\circ}\text{C}$ , $I_O = 5\text{mA to } 1.5\text{A}$			100	mV	
		$T_J = +25^{\circ}\text{C}$ , $I_O = 250\text{mA to } 750\text{mA}$			50		
Quiescent Current	IQ	$T_J = +25^{\circ}\text{C}$			6	mA	
Quiescent Current Change	$\Delta I_Q$	$I_O = 5\text{mA to } 1\text{A}$			0.5	mA	
		$V_I = 15\text{V to } 30\text{V}$			1		
Quiescent Current Change	$\Delta V_O / \Delta T$	$I_O = 5\text{mA}$		1.5		mV/ $^{\circ}\text{C}$	
Short Circuit Current	ISC	$T_J = +25^{\circ}\text{C}$ , $V_I = 35\text{V}$		0.75	1.2	A	

LNR: Line Regulation. The change in output voltage for a change in the input voltage. The measurement is made under conditions of low dissipation or by using pulse techniques such that the average chip temperature is not significantly affected.

LDR: Load Regulation. The change in output voltage for a change in load current at constant chip temperature.

**Typical Characteristics**

Figure 1: Dropout Voltage vs Junction Temperature

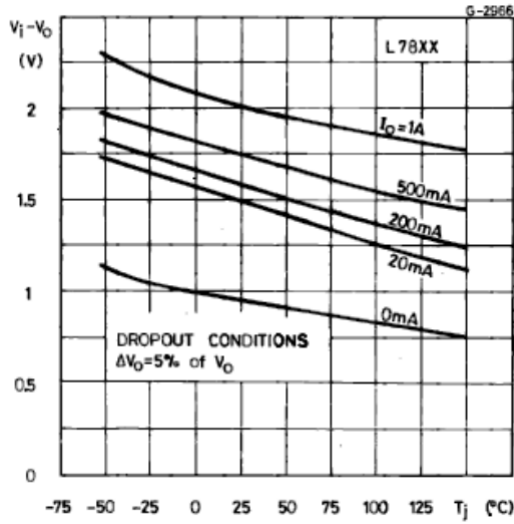

Figure 2: Peak Output Current vs Input/output Differential Voltage

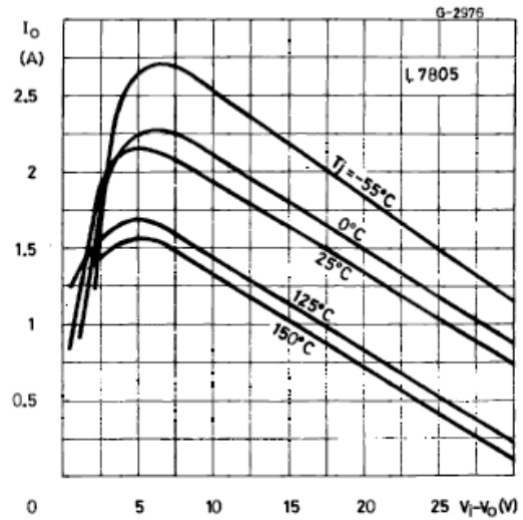

Figure 3: Supply Voltage Rejection vs Frequency Temperature

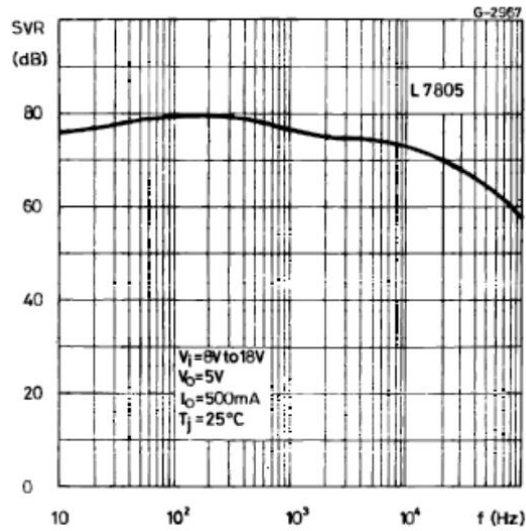

Figure 4: Quiescent Current vs Junction

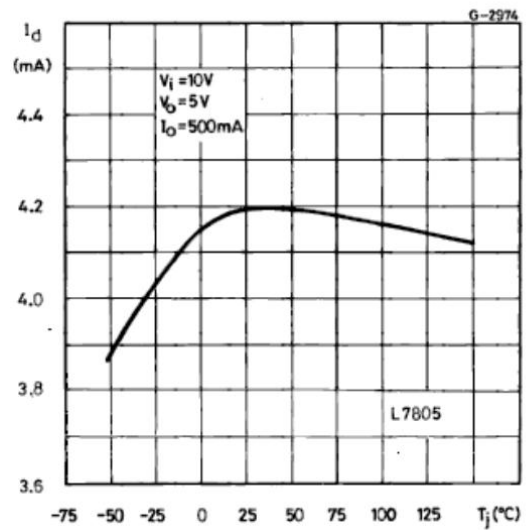

Figure 5: Output Voltage vs Junction Temperature

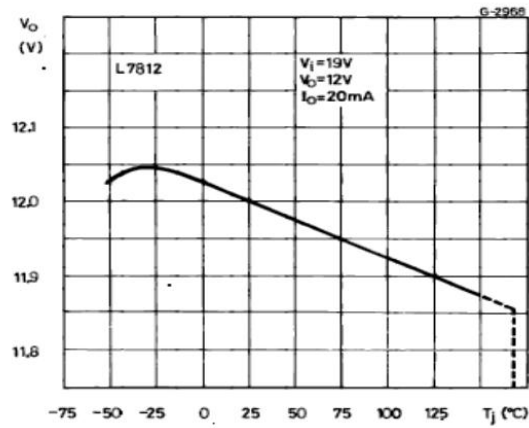

Figure 6: Load Transient Response

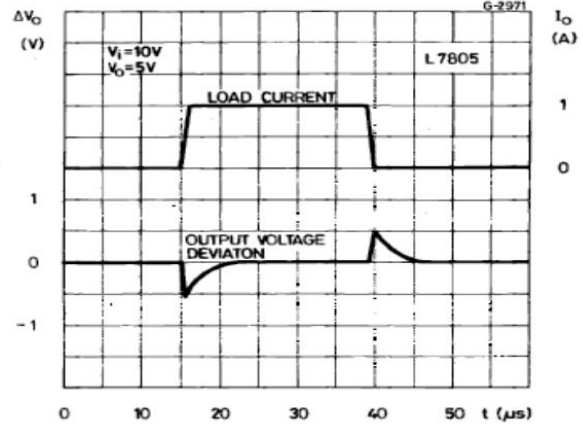

Figure 7: Output Impedance vs Frequency

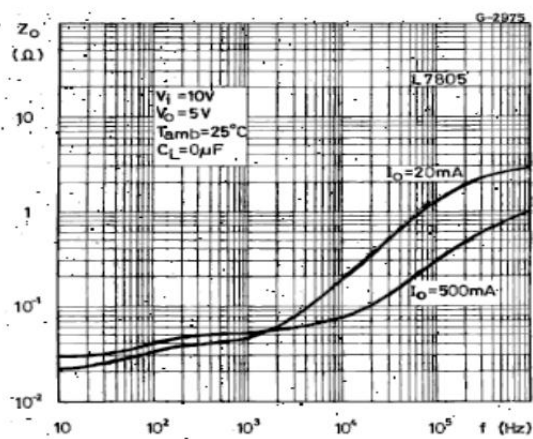

Figure 8: Line Transient Response

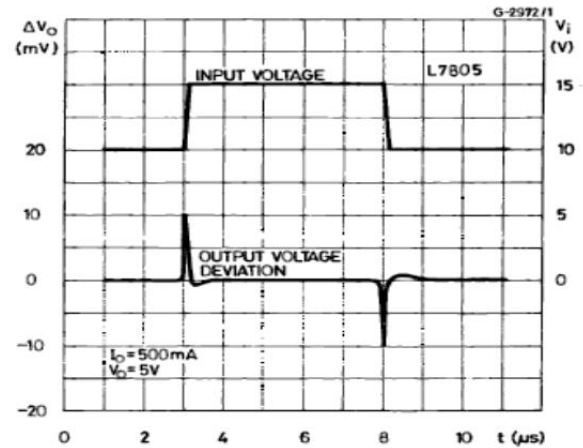
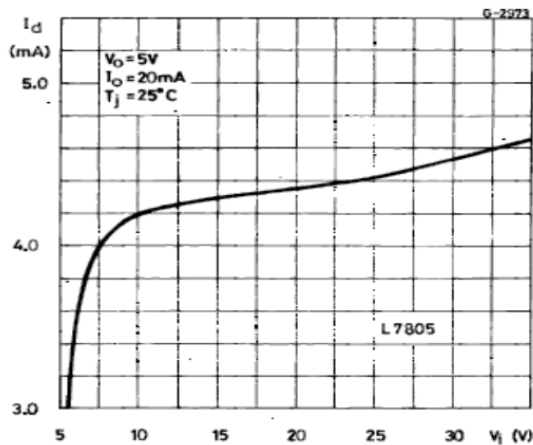

Figure 9: Quiescent Current vs Input Voltage



**Operation Description**

HE78XX is designed with Thermal Overload Protection that shuts down the circuit when subjected to an excessive power overload condition, Internal Short Circuit Protection that limits the maximum current the circuit will pass, and Output Transistor Safe-Area Compensation that reduces the output short circuit current as the voltage across the pass transistor is increased.

In many low current applications, compensation capacitors are not required. However, it is recommended that the regulator input be bypassed with a capacitor if the regulator is connected to the power supply filter with long wire lengths, or if the output load capacitance is large. An input bypass capacitor should be selected to provide good high frequency characteristics to insure stable operation under all load conditions. A 0.33µF or larger tantalum, mylar, or other capacitor having low internal impedance at high frequencies should be chosen. The bypass capacitor should be mounted with the shortest possible leads directly across the regulator's input terminals. Normally good construction techniques should be used to minimize ground loops and lead resistance drops since the regulator has no external sense lead.

**Typical Application**

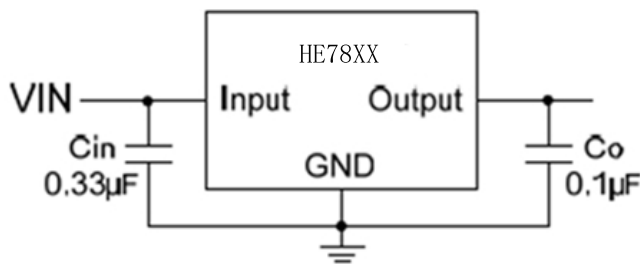

**Fig.1 Fixed Output Regulator**

A common ground is required between the input and the output voltages. The input voltage must remain typically 2.0 V above the output voltage even during the low point on the input ripple voltage.

- Cin is required if regulator is located an appreciable distance from power supply filter.
- Co is not needed for stability; however, it does improve transient response.

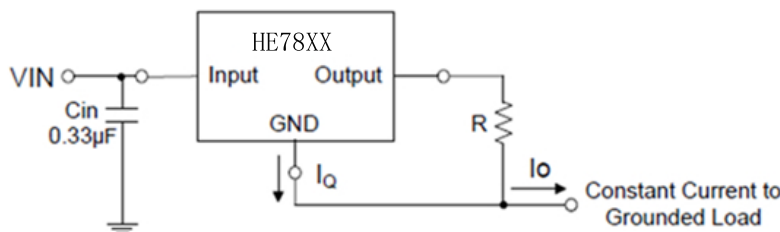

**Fig.2 Constant Current Regulator**

The HE78XX regulator can also be used as a current source when connected as Fig.2. In order to minimize dissipation the HE78XX is chosen in this application. Resistor R determines the current as

$$I_o = \frac{5V}{R} + I_q$$

follows:



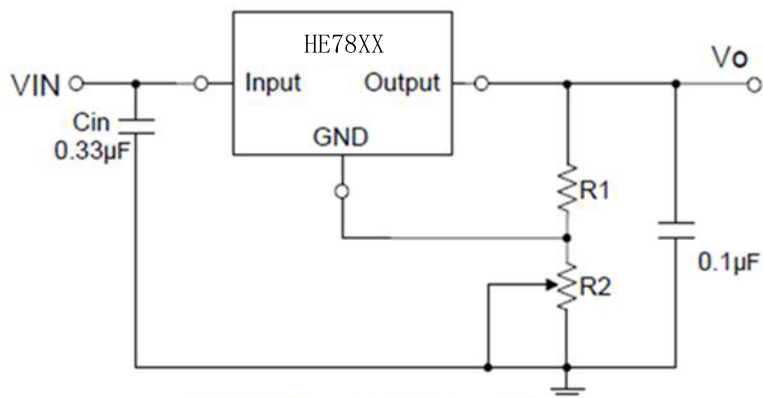

Fig.3 Adjustable Output Regulator

$$V_o = 5V + (5V/R_1 + I_Q) * R_2$$

$$5V/R_1 > 3 * I_Q$$

**Package Information**

TO-220 MECHANICAL DATA

DIM.	mm			inch		
	MIN.	TYP.	MAX.	MIN.	TYP.	MAX.
A	4.40		4.60	0.173		0.181
C	1.23		1.32	0.048		0.051
D	2.40		2.72	0.094		0.107
D1		1.27			0.050	
E	0.49		0.70	0.019		0.027
F	0.61		0.88	0.024		0.034
F1	1.14		1.70	0.044		0.067
F2	1.14		1.70	0.044		0.067
G	4.95		5.15	0.194		0.203
G1	2.4		2.7	0.094		0.106
H2	10.0		10.40	0.393		0.409
L2		16.4			0.645	
L4	13.0		14.0	0.511		0.551
L5	2.65		2.95	0.104		0.116
L6	15.25		15.75	0.600		0.620
L7	6.2		6.6	0.244		0.260
L9	3.5		3.93	0.137		0.154
DIA.	3.75		3.85	0.147		0.151

