

OUTLINE DRAWING

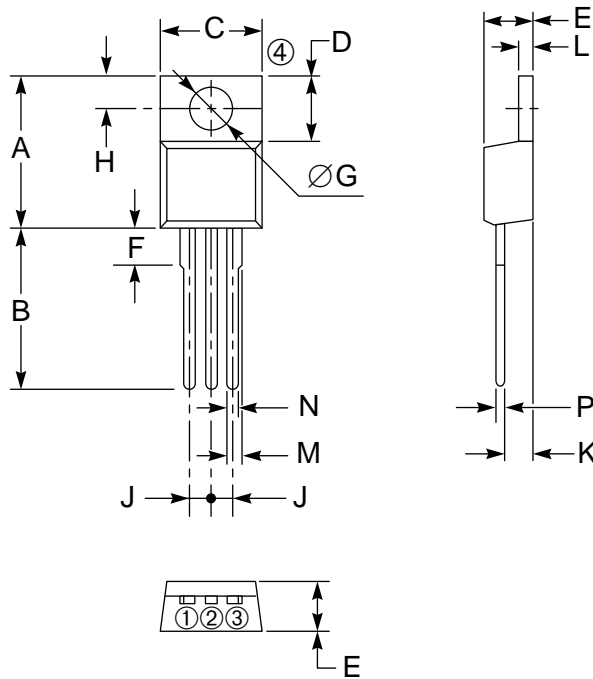

CONNECTION DIAGRAM

- ① T1 TERMINAL
- ② T2 TERMINAL
- ③ GATE
- ④ T2 TERMINAL

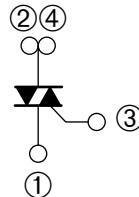

Outline Drawing (Conforms to TO-220)

Dimensions	Inches	Millimeters
A	0.63 Max.	16.0 Max.
B	0.49 Max.	12.5 Max.
C	0.41 Max.	10.5 Max.
D	0.28	7.0
E	0.18	4.5
F	0.15 Max.	3.8 Max.
G	0.142 ± 0.008 Dia.	3.6 ± 0.2 Dia.

Dimensions	Inches	Millimeters
H	0.125 ± 0.008	3.2 ± 0.2
J	0.99	2.54
K	0.10	2.6
L	0.051	1.3
M	0.051	1.3
N	0.031	0.8
P	0.020	0.5

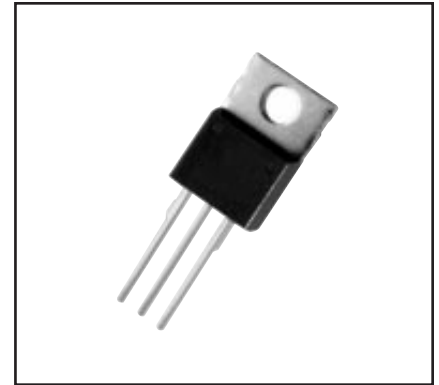

Description:

A triac is a solid state silicon AC switch which may be gate triggered from an off-state to an on-state for either polarity of applied voltage.

Features:

- Planar Passivation
- Selected for Inductive Loads

Applications:

- AC Switch
- Heating
- Motor Controls
- Switch Mode Power Supply
- Lighting
- Solid State Relay

Ordering Information:

Example: Select the complete eight, nine or ten digit part number you desire from the table - i.e. BCR20AM-8 is a 400 Volt, 20 Ampere Triac

Type	V _{DRM} Volts	Code	Inductive Load*
BCR20AM	400	-8	L
	600	-12	

*For inductive load, add L.

BCR20AM

Triac

20 Ampere/400-600 Volts

Absolute Maximum Ratings, $T_a = 25^\circ\text{C}$ unless otherwise specified

Ratings	Symbol	BCR20AM-8	BCR20AM-12	Units
On-state Current, $T_c = 105^\circ\text{C}$	$I_{T(RMS)}$	20	20	Amperes
Repetitive Peak Off-state Voltage (Gate Open)	V_{DRM}	400	600	Volts
Non-repetitive Peak Off-state Voltage (Gate Open)	V_{DSM}	500	720	Volts
Non-repetitive Peak On-state Voltage, One Cycle (60 Hz)	I_{TSM}	200	200	Amperes
I^2t for Fusing, $t = 8.3$ msec	I^2t	167	167	A^2sec
Peak Gate Power Dissipation, 20 μsec	P_{GM}	5	5	Watts
Average Gate Power Dissipation	$P_{G(avg)}$	0.5	0.5	Watts
Peak Gate Current	I_{GM}	2	2	Amperes
Peak Gate Voltage	V_{GM}	10	10	Volts
Storage Temperature	T_{stg}	-40 to 125	-40 to 125	$^\circ\text{C}$
Operating Temperature	T_j	-40 to 125	-40 to 125	$^\circ\text{C}$
Weight	—	2.0	2.0	Grams

Electrical and Thermal Characteristics, $T_j = 25^\circ\text{C}$ unless otherwise specified

Characteristics	Symbol	Test Conditions (Trigger Mode)				BCR30GM			Units
		V_D	R_L	R_G	T_j	Min.	Typ.	Max.	
Gate Parameters									
DC Gate Trigger Current									
MT2+ Gate+	$I_{FGT I}$	6V	6 Ω	330 Ω	25 $^\circ\text{C}$	—	—	30	mA
MT2+ Gate-	$I_{RGT I}$	6V	6 Ω	330 Ω	25 $^\circ\text{C}$	—	—	30	mA
MT2- Gate-	$I_{RGT III}$	6V	6 Ω	330 Ω	25 $^\circ\text{C}$	—	—	30	mA
DC Gate Trigger Voltage									
MT2+ Gate+	$V_{FGT I}$	6V	6 Ω	330 Ω	25 $^\circ\text{C}$	—	—	1.5	Volts
MT2+ Gate-	$V_{RGT I}$	6V	6 Ω	330 Ω	25 $^\circ\text{C}$	—	—	1.5	Volts
MT2- Gate-	$V_{RGT III}$	6V	6 Ω	330 Ω	25 $^\circ\text{C}$	—	—	1.5	Volts
DC Gate Non-trigger Voltage									
All	V_{GD}	1/2 V_{DRM}	—	—	125 $^\circ\text{C}$	0.2	—	—	Volts
Thermal Resistance, Junction-to-case	$R_{th(j-c)}$	—	—	—	—	—	—	0.8	$^\circ\text{C}/\text{W}$
Voltage – Blocking State Repetitive Off-state Current	I_{DRM}	Gate Open Circuited, $V_D = V_{DRM}$, $T_j = 125^\circ\text{C}$				—	—	2	mA
Current – Conducting State Peak On-state Voltage	V_{TM}	$T_c = 25^\circ\text{C}$, $I_{TM} = 30\text{A}$				—	—	1.5	Volts
Critical Rate-of-Rise of Commutating Off-state Voltage (Commutating dv/dt) ▲ (Switching)	$(dv/dt)_C$	—				—	—	—	$\text{V}/\mu\text{s}$

Δ Part Number	V_{DRM} (Volts)	Commutating dv/dt , $(dv/dt)_C$ ($\text{V}/\mu\text{sec}$) Minimum	Test Condition	Commutating Voltage & Current Waveform (Inductive Load)
BCR20AM-8	400	—	$T_j = 125^\circ\text{C}$, Rate of Decay	
BCR20AM-8L		10	On-state Commutating Current	
BCR20AM-12	600	—	$(dv/dt)_C = -10\text{A}/\text{msec}$,	
BCR20AM-12L		10	Peak Off-state Voltage $V_D = 400\text{V}$	

BCR20AM

Triac

20 Ampere/400-600 Volts

MAXIMUM ON-STATE CHARACTERISTICS

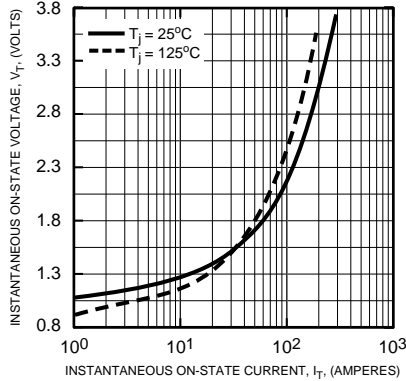

TRANSIENT THERMAL IMPEDANCE CHARACTERISTICS (JUNCTION-TO-CASE)

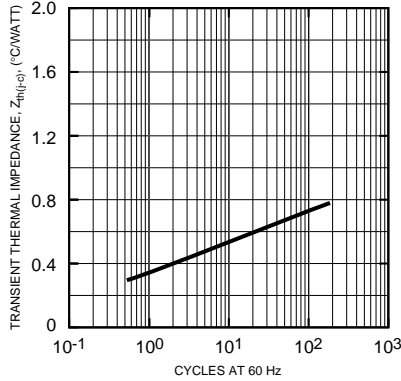

GATE CHARACTERISTICS (I, II, III)

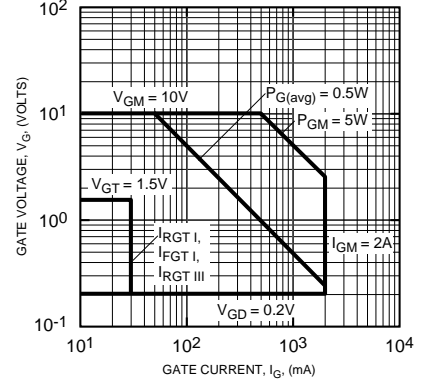

MAXIMUM SURGE CURRENT FOLLOWING RATED LOAD CONDITIONS

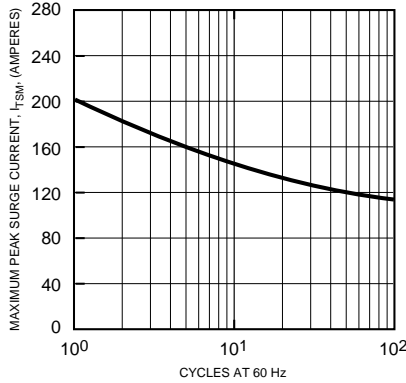

ALLOWABLE CASE TEMPERATURE VS. RMS ON-STATE CURRENT

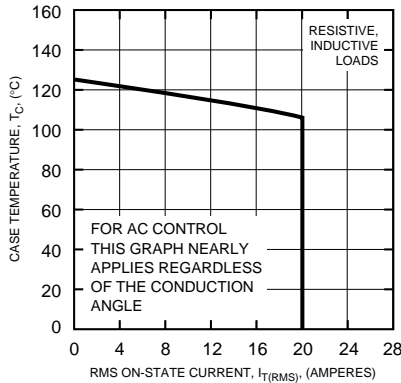

ALLOWABLE AMBIENT TEMPERATURE VS. RMS ON-STATE CURRENT

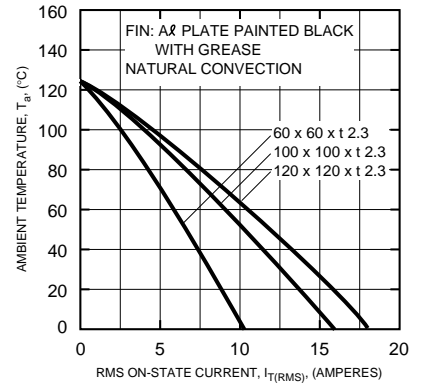

ALLOWABLE AMBIENT TEMPERATURE VS. RMS ON-STATE CURRENT

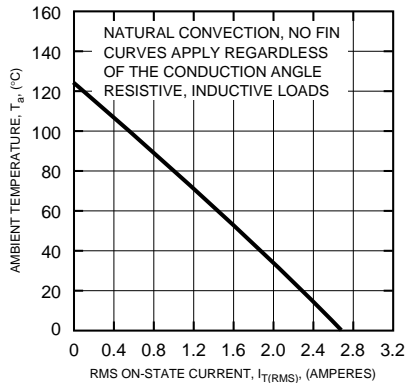

MAXIMUM ON-STATE POWER DISSIPATION

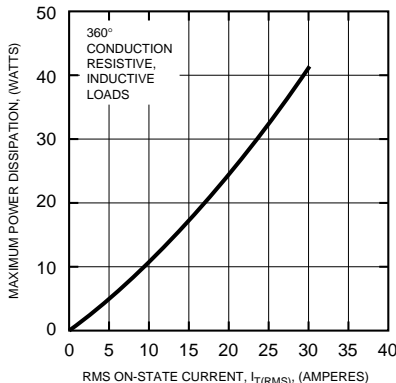

GATE TRIGGER CURRENT VS. JUNCTION TEMPERATURE (TYPICAL)

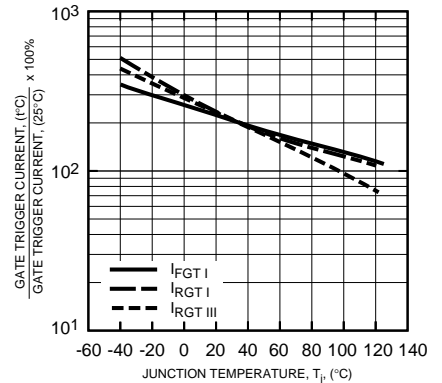

BCR20AM

Triac

20 Ampere/400-600 Volts

GATE TRIGGER VOLTAGE VS. JUNCTION TEMPERATURE (TYPICAL)

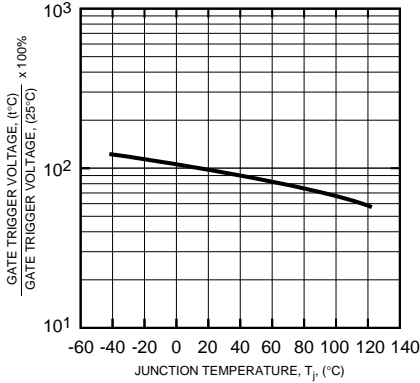

HOLDING CURRENT VS. JUNCTION TEMPERATURE (TYPICAL)

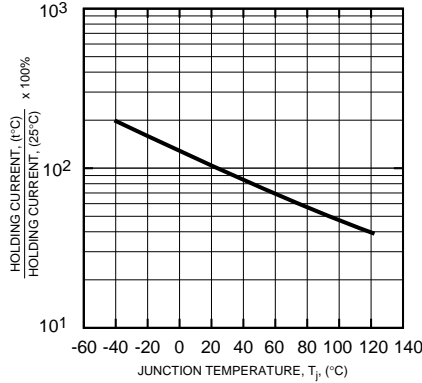

LATCHING CURRENT VS. JUNCTION TEMPERATURE (TYPICAL)

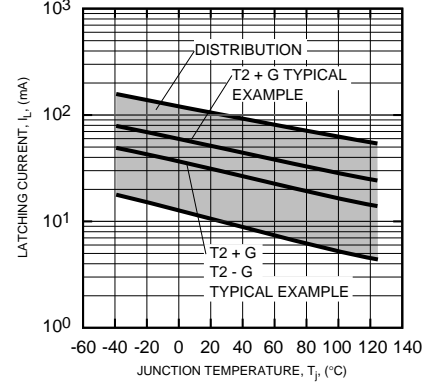

BREAKOVER VOLTAGE VS. JUNCTION TEMPERATURE (TYPICAL)

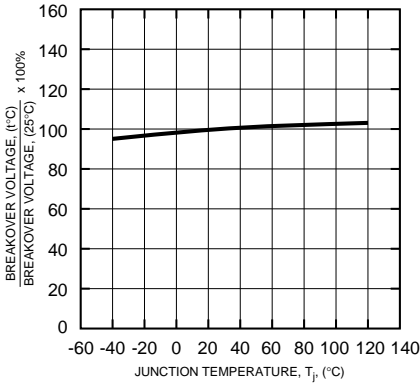

BREAKOVER VOLTAGE VS. RATE OF RISE OF OFF-STATE VOLTAGE (TYPICAL)

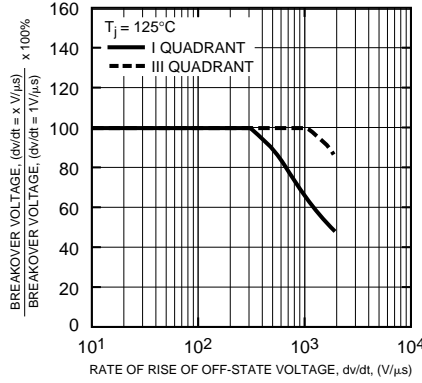

REPETITIVE PEAK OFF-STATE CURRENT VS. JUNCTION TEMPERATURE (TYPICAL)

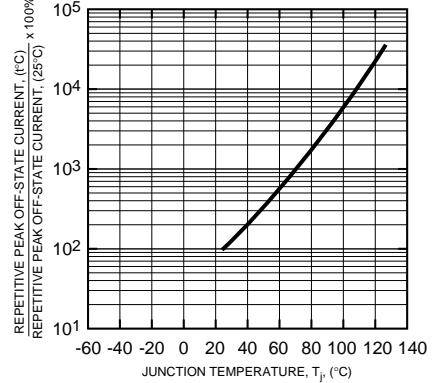

COMMUTATION CHARACTERISTICS (TYPICAL)

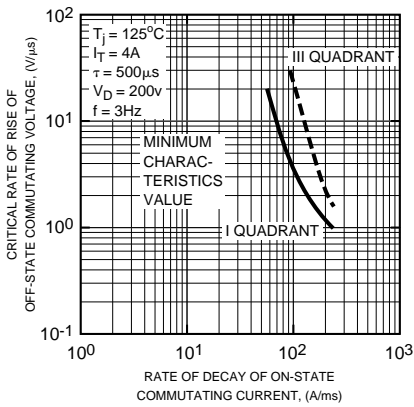

GATE TRIGGER CURRENT VS. GATE CURRENT PULSE WIDTH (TYPICAL)

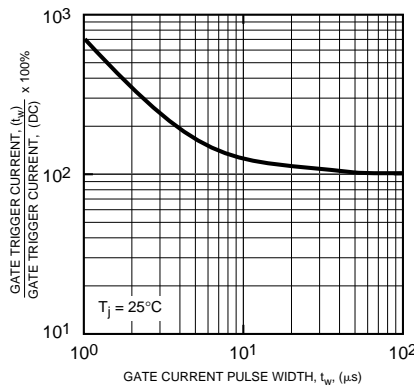

GATE TRIGGER CHARACTERISTICS TEST CIRCUITS

