

Surface Mount Fast Recovery Rectifier

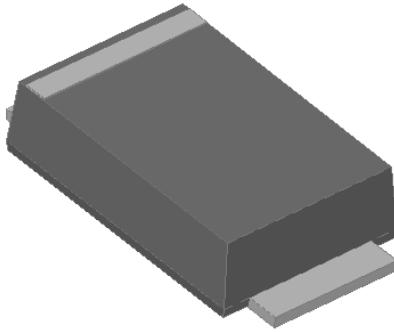

Features

- Low profile package
- Ideal for automated placement
- Glass passivated chip junction
- High forward surge capability
- Fast reverse recovery time
- Meets MSL level 1, per J-STD-020, LF maximum peak of 260 °C

Typical Applications

For use in high frequency rectification of power supplies, inverters, converters, and freewheeling diodes for consumer, and telecommunication.

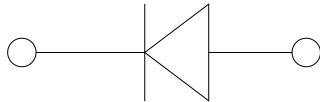

Mechanical Data

- **Package:** SMAF
Molding compound meets UL 94 V-0 flammability rating, RoHS-compliant, halogen-free
- **Terminals:** Tin plated leads, solderable per J-STD-002 and JESD22-B102
- **Polarity:** Cathode line denotes the cathode end

■ Maximum Ratings (T_a=25°C Unless otherwise specified)

PARAMETER	SYMBOL	UNIT	F1AFS	F1BFS	F1DFS	F1GFS	F1JFS	F1KFS	F1MFS
Device marking code			F1AFS	F1BFS	F1DFS	F1GFS	F1JFS	F1KFS	F1MFS
Repetitive peak reverse voltage	VRRM	V	50	100	200	400	600	800	1000
Average rectified output current @60Hz sine wave, resistance load, TL (Fig.1)	I _O	A	1.0						
Surge(non-repetitive)forward current @60Hz half-sine wave,1 cycle, T _a =25°C	I _{FSM}	A	30						
Storage temperature	T _{stg}	°C	-55~+150						
Junction temperature	T _j	°C	-55~+150						

■ Electrical Characteristics (T_a=25°C Unless otherwise specified)

PARAMETER	SYMBOL	UNIT	TEST CONDITIONS	F1AFS	F1BFS	F1DFS	F1GFS	F1JFS	F1KFS	F1MFS
Maximum instantaneous forward voltage drop per diode	V _F	V	I _{FM} =1.0A	1.3						
Maximum reverse recovery time	t _r	ns	I _F =0.5A, I _R =1.0A, I _r =0.25A	150			250		500	
Maximum DC reverse current at rated DC blocking voltage per diode @ V _{RM} =V _{RRM}	I _{RRM}	μA	T _a =25°C	5.0						
			T _a =125°C	100						



F1AFS THRU F1MFS

■ Thermal Characteristics (T_a=25°C Unless otherwise specified)

PARAMETER	SYMBOL	UNIT	F1AFS	F1BFS	F1DFS	F1GFS	F1JFS	F1KFS	F1MFS
Thermal resistance	R _{θJ-A} ⁽¹⁾	°C/W	70 ⁽¹⁾						
	R _{θJ-L} ⁽¹⁾		25 ⁽¹⁾						

Note:
 (1) Thermal resistance from junction to ambient and from junction to lead mounted on P.C.B. with 0.2" x 0.2" (5.0 mm x 5.0 mm) copper pad areas

■ Characteristics (Typical)

FIG1: I_o-T_L Curve

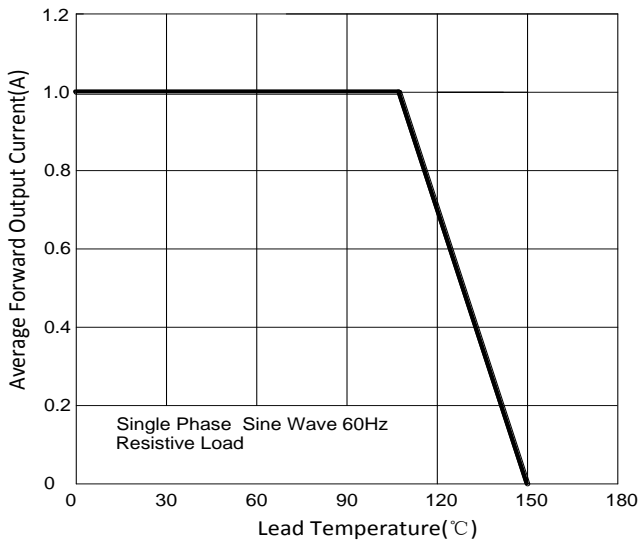

FIG2: Surge Forward Current Capability

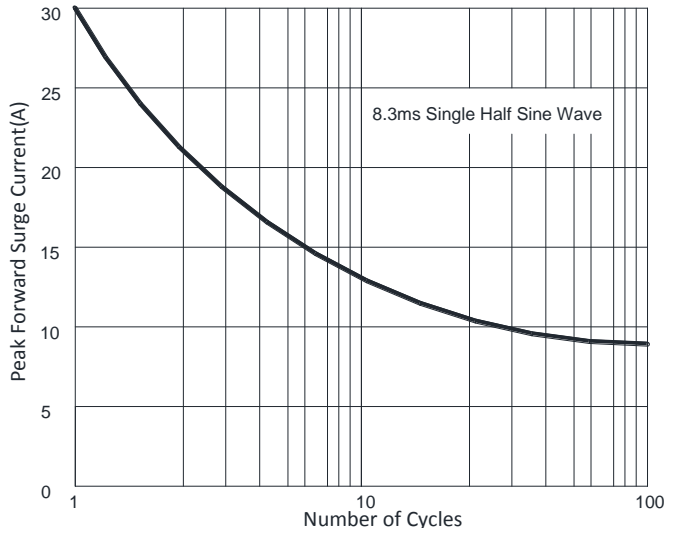

FIG3: Forward Voltage

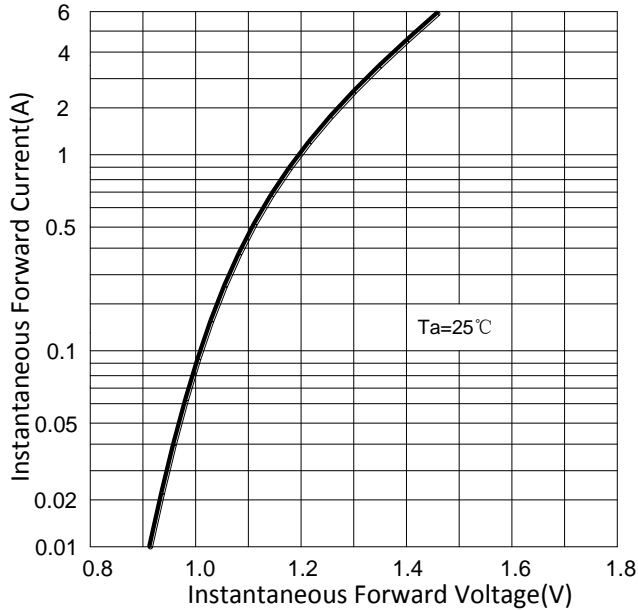
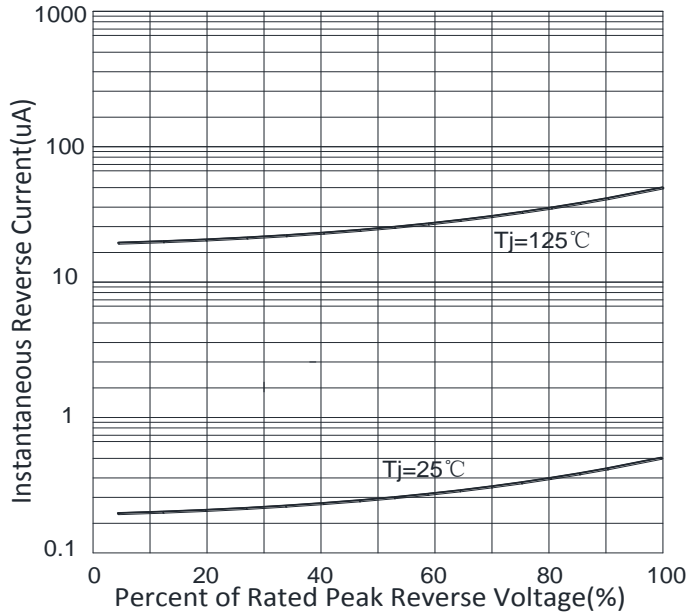

FIG4: Typical Reverse Characteristics





F1AFS THRU F1MFS

FIG.5: Diagram of circuit and Testing wave form of reverse recovery time

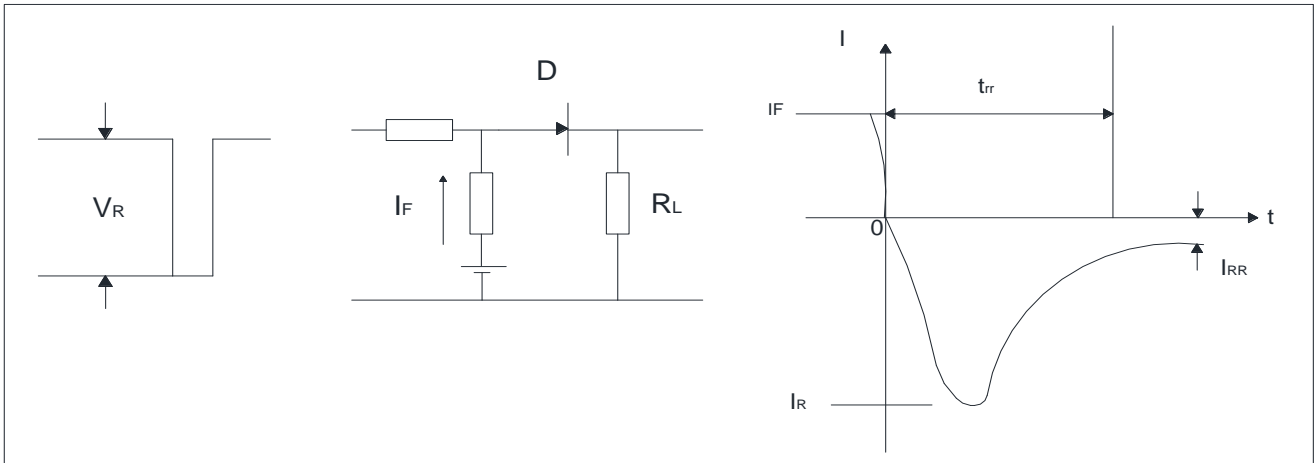

Ordering Information (Example)

PREFERED P/N	PACKING CODE	UNIT WEIGHT(g)	MINIMUM PACKAGE(pcs)	INNER BOX QUANTITY(pcs)	OUTER CARTON QUANTITY(pcs)	DELIVERY MODE
F1AFS-F1MFS	F1	Approximate 0.034	3000	12000	96000	7" reel
F1AFS-F1MFS	F2	Approximate 0.034	10000	20000	160000	13" reel
F1AFS-F1MFS	F3	Approximate 0.034	10000	20000	120000	13" reel
F1AFS-F1MFS	F4	Approximate 0.034	7500	15000	120000	13" reel

Outline Dimensions

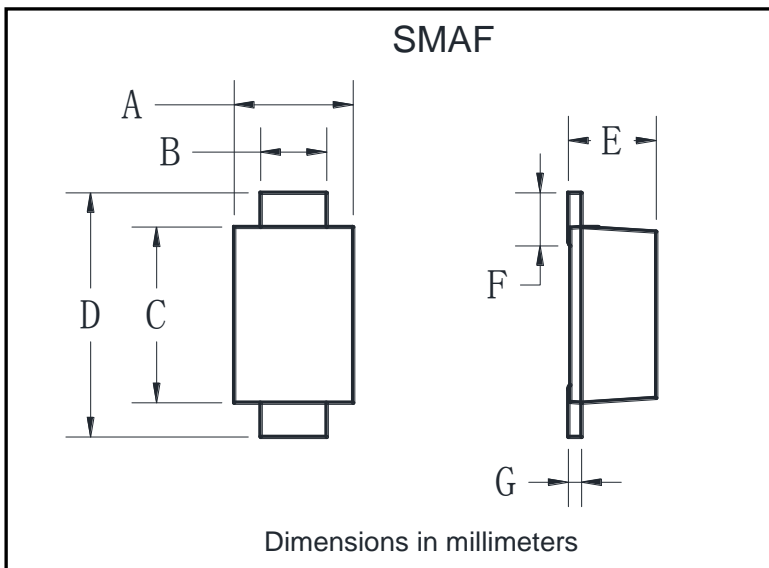

SMAF		
Dim	Min	Max
A	2.40	2.80
B	1.35	1.45
C	3.40	3.60
D	4.40	4.80
E	1.05	1.25
F	0.50	1.00
G	0.15	0.22



F1AFS THRU F1MFS

■ Suggested pad layout

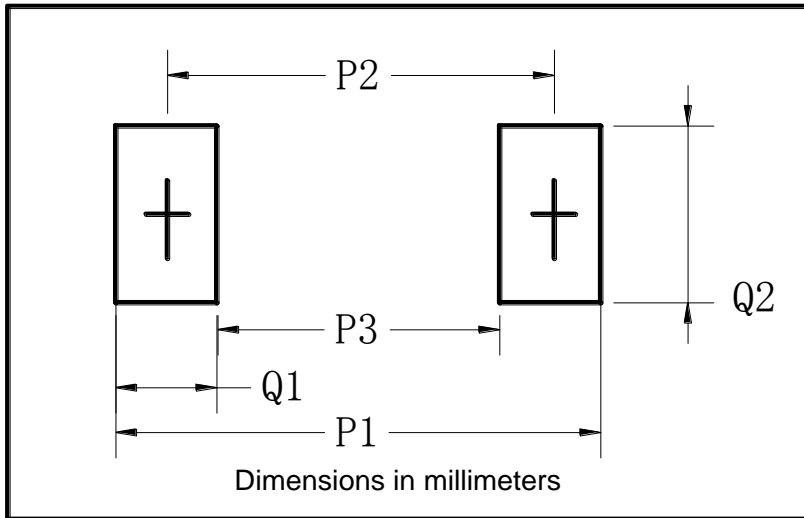

SMAF	
Dim	Millimeters
P1	6.50
P2	4.00
P3	1.50
Q1	2.50
Q2	1.70



F1AFS THRU F1MFS

Disclaimer

The information presented in this document is for reference only. Yangzhou Yangjie Electronic Technology Co., Ltd. reserves the right to make changes without notice for the specification of the products displayed herein to improve reliability, function or design or otherwise.

The product listed herein is designed to be used with ordinary electronic equipment or devices, and not designed to be used with equipment or devices which require high level of reliability and the malfunction of which would directly endanger human life (such as medical instruments, transportation equipment, aerospace machinery, nuclear-reactor controllers, fuel controllers and other safety devices), Yangjie or anyone on its behalf, assumes no responsibility or liability for any damages resulting from such improper use of sale.

This publication supersedes & replaces all information previously supplied. For additional information, please visit our website [http:// www.21yangjie.com](http://www.21yangjie.com) , or consult your nearest Yangjie's sales office for further assistance.