

Features

- Temperature-compensated: 30 ppm/°C
- Trimmed bandgap reference
- Internal amplifier with 150 mA capability
- Multiple temperature ranges
- Low frequency dynamic output impedance: < 150 mΩ
- Low output noise
- Robust ESD protection

Description

The AS431 is a three-terminal adjustable shunt regulator providing a highly accurate bandgap reference. The adjustable shunt regulator is ideal for a wide variety of linear applications that can be implemented using external components to obtain adjustable currents and voltages.

In the standard shunt configuration, the combination of low temperature coefficient (TC), sharp turn-on characteristics, low output impedance and programmable output voltage make this precision reference a perfect zener diode replacement.

The AS431 precision adjustable shunt reference is offered in four bandgap tolerances: ±0.25%, ±0.5%, ±1.0%, and ±2.0%.

Pin Configuration — Top view

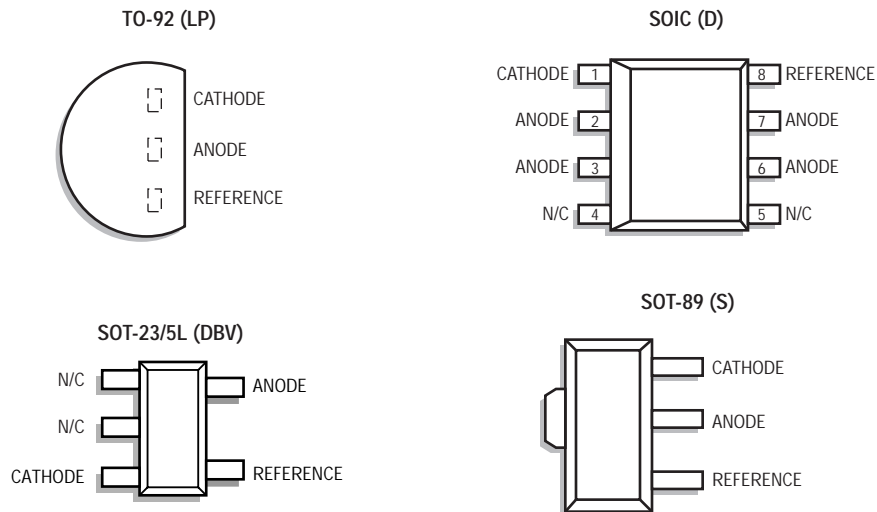

Ordering Information

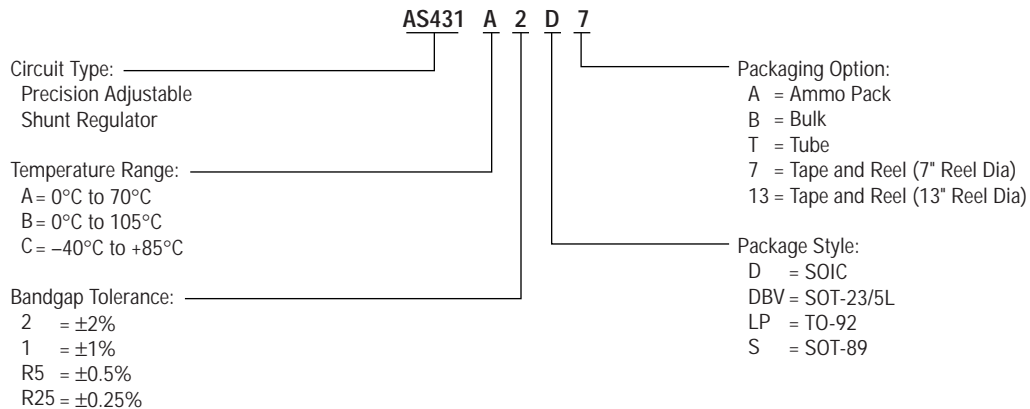

Functional Block Diagram

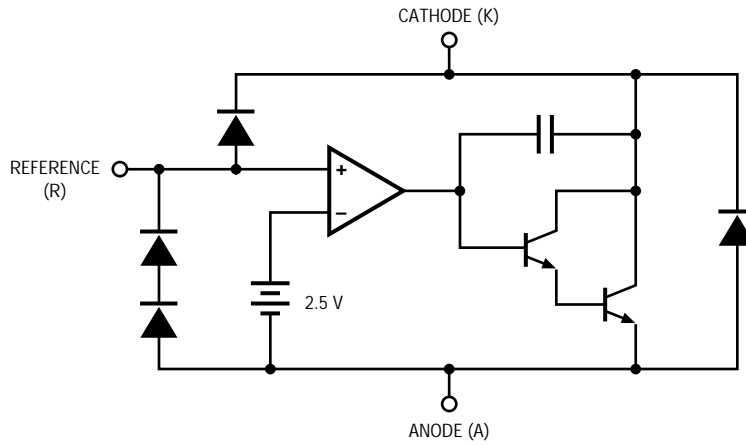

Absolute Maximum Ratings

Parameter	Symbol	Rating	Units
Cathode-Anode Reverse Breakdown	V_{KA}	37	V
Anode-Cathode Forward Current	I_{AK}	1	A
Operating Cathode Current	I_{KA}	250	mA
Reference Input Current	I_{REF}	10	mA
Continuous Power at 25°C	P_D		
TO-92		775	mW
8L SOIC		750	mW
SOT-89		1000	mW
SOT-23/5L		200	mW
Junction Temperature	T_J	150	°C
Storage Temperature	T_{STG}	-65 to 150	°C
Lead Temperature, Soldering 10 Seconds	T_L	300	°C

Stresses greater than those listed under ABSOLUTE MAXIMUM RATINGS may cause permanent damage to the device. This is a stress rating only and functional operation of the device at these or any other conditions above those indicated in the operational sections of this specification is not implied. Exposure to absolute maximum rating conditions for extended periods may affect reliability.

Recommended Conditions

Parameter	Symbol	Rating	Unit
Cathode Voltage	V_{KA}	V_{REF} to 20	V
Cathode Current	I_K	10	mA

Typical Thermal Resistances

Package	θ_{JA}	θ_{JC}	Typical Derating
TO-92	160°C/W	80°C/W	6.3 mW/°C
SOIC	175°C/W	45°C/W	5.7 mW/°C
SOT-89	110°C/W	8°C/W	9.1 mW/°C
SOT-23/5L	575°C/W	150°C/W	1.7 mW/°C

Electrical Characteristics

Electrical Characteristics are guaranteed over full junction temperature range (0 to 105°C). Ambient temperature must be derated based on power dissipation and package thermal characteristics. The conditions are: $V_{KA} = V_{REF}$ and $I_K = 10$ mA unless otherwise stated.

Parameter	Symbol	Test Condition	AS431 (0.25%)			AS431 (0.5%)			Unit	Test Circuit
			Min.	Typ.	Max.	Min.	Typ.	Max.		
Reference Voltage	V_{REF}	$T_A = 25^\circ\text{C}$	2.496	2.503	2.509	2.490	2.503	2.515	V	1
		Over temp.	2.475		2.530	2.469		2.536	V	1
ΔV_{REF} with Temp*	TC			0.07	0.20		0.07	0.20	mV/°C	1
Ratio of Change in V_{REF} to Cathode Voltage	$\frac{\Delta V_{REF}}{\Delta V_K}$	V_{REF} to 10 V	-2.7	-1.0		-2.7	-1.0		mV/V	2
		10 V to 36 V	-2	-0.4	0.3	-2	-0.4	0.3		
Reference Input Current	I_{REF}			0.7	4		0.7	4	μA	2
I_{REF} Temp Deviation	ΔI_{REF}	Over temp.		0.4	1.2		0.4	1.2	μA	2
Min I_K for Regulation	$I_{K(\text{min})}$			0.4	1		0.4	1	mA	1
Off State Leakage	$I_{K(\text{off})}$	$V_{REF} = 0$ V, $V_{KA} = 36$ V		0.04	250		0.04	250	nA	3
Dynamic Output Impedance	Z_{KA}	$f \leq 1$ kHz $I_K = 1$ to 150 mA		0.15	0.5		0.15	0.5	Ω	1

Parameter	Symbol	Test Condition	AS431 (1.0%)			AS431 (2.0%)			Unit	Test Circuit
			Min.	Typ.	Max.	Min.	Typ.	Max.		
Reference Voltage	V_{REF}	$T_A = 25^\circ\text{C}$	2.470	2.495	2.520	2.440	2.490	2.550	V	1
		Over temp.	2.449		2.541	2.430		2.569	V	1
ΔV_{REF} with Temp*	TC			0.07	0.20		0.07	0.20	mV/°C	1
Ratio of Change in V_{REF} to Cathode Voltage	$\frac{\Delta V_{REF}}{\Delta V_K}$	V_{REF} to 10 V	-2.7	-1.0		-2.7	-1.0		mV/V	2
		10 V to 36 V	-2	-0.4	0.3	-2	-0.4	0.3		
Reference Input Current	I_{REF}			0.7	4		0.7	4	μA	2
I_{REF} Temp Deviation	ΔI_{REF}	Over temp.		0.4	1.2		0.4	1.2	μA	2
Min I_K for Regulation	$I_{K(\text{min})}$			0.4	1		0.4	1	mA	1
Off State Leakage	$I_{K(\text{off})}$	$V_{REF} = 0$ V, $V_{KA} = 36$ V		0.04	250		0.04	250	nA	3
Dynamic Output Impedance	Z_{KA}	$f \leq 1$ kHz $I_K = 1$ to 150 mA		0.15	0.5		0.15	0.5	Ω	1

*Calculating Average Temperature Coefficient (TC). Refer to following page.

Average Temperature Coefficient

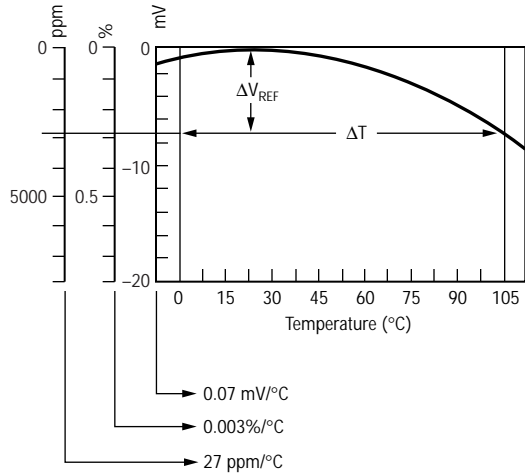

- TC in mV/°C = $\frac{\Delta V_{REF} \text{ (mV)}}{\Delta T_A}$
- TC in %/°C = $\frac{\left(\frac{\Delta V_{REF}}{V_{REF} \text{ at } 25^\circ\text{C}}\right) \times 100}{\Delta T_A}$
- TC in ppm/°C = $\frac{\left(\frac{\Delta V_{REF}}{V_{REF} \text{ at } 25^\circ\text{C}}\right) \times 10^6}{\Delta T_A}$

Test Circuits

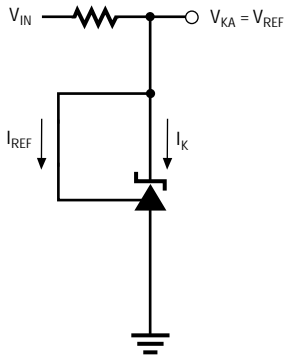

Figure 1a. Test Circuit 1

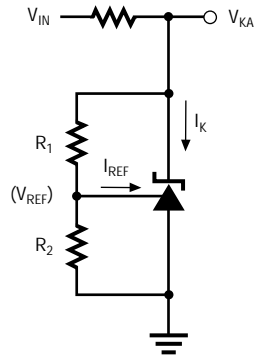

Figure 1b. Test Circuit 2

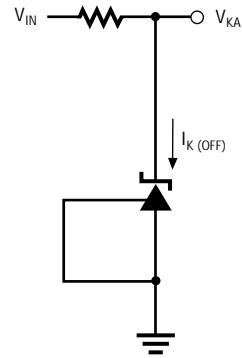

Figure 1c. Test Circuit 3

Typical Performance Curves

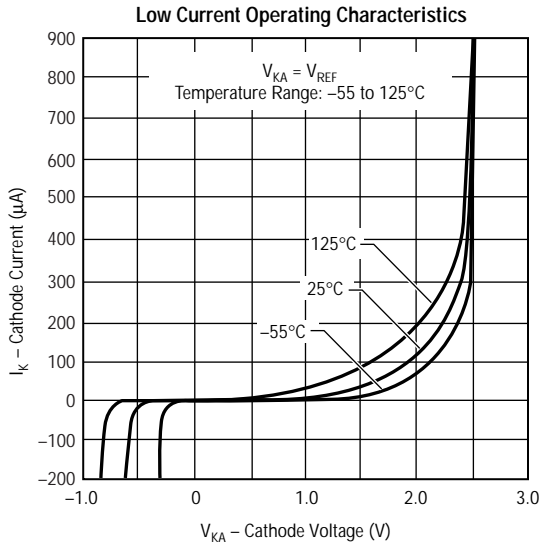

Figure 2

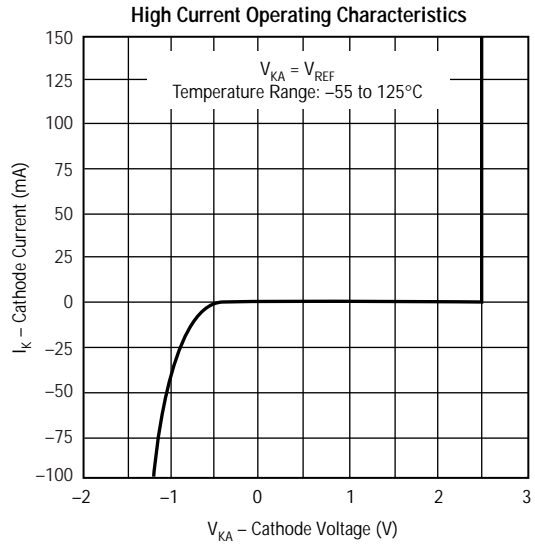

Figure 3

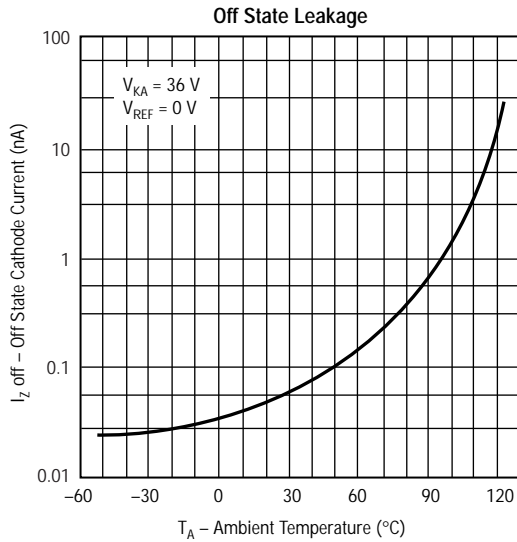

Figure 4

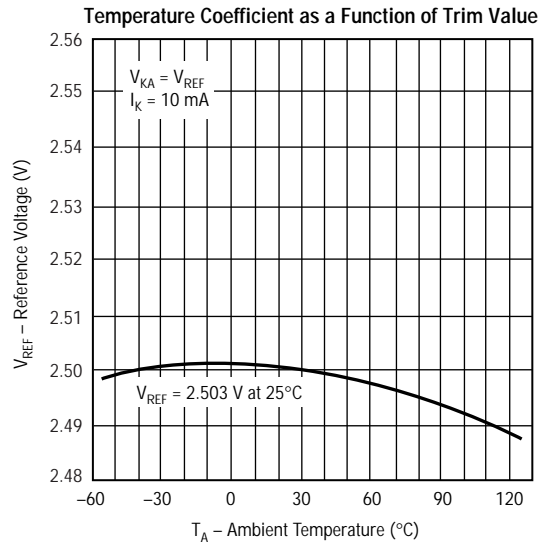

Figure 5

Typical Performance Curves

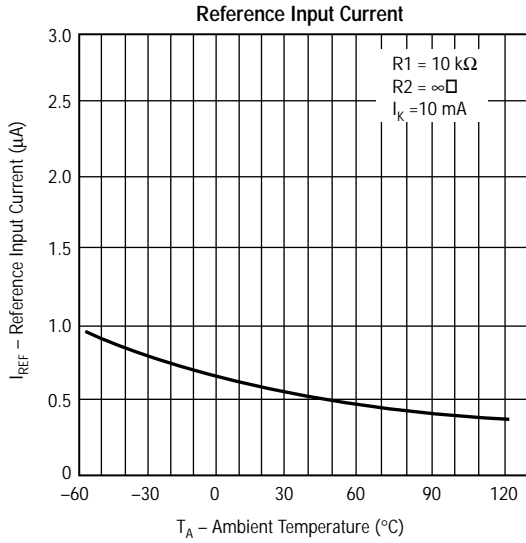

Figure 6

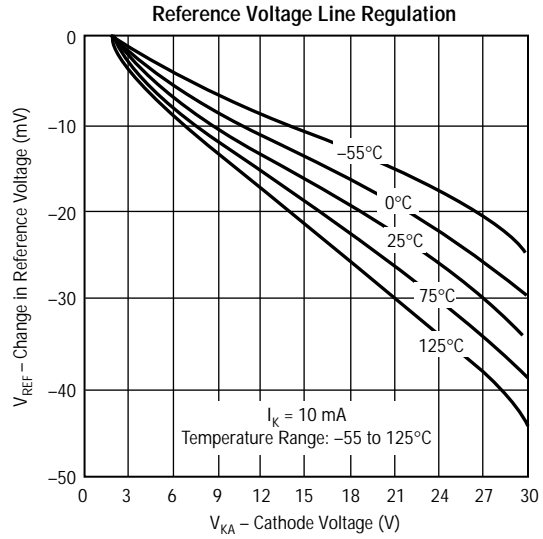

Figure 7

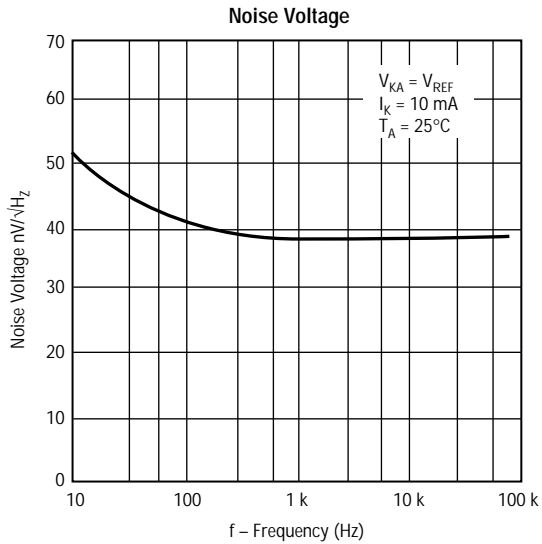

Figure 8

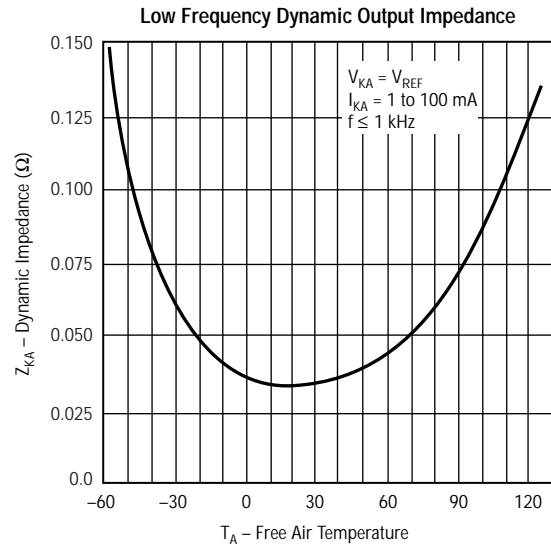

Figure 9

Typical Performance Curves

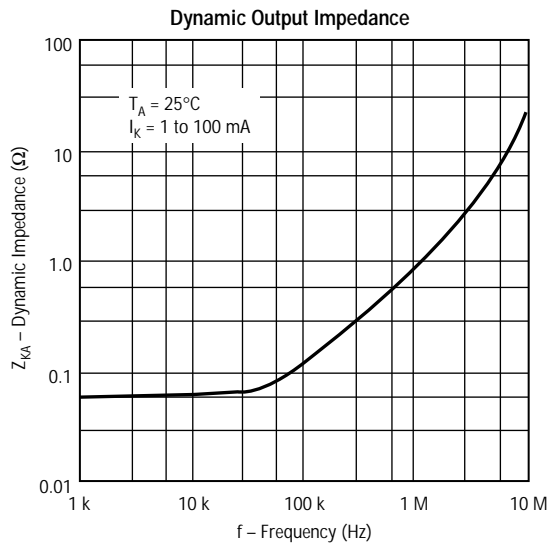

Figure 10

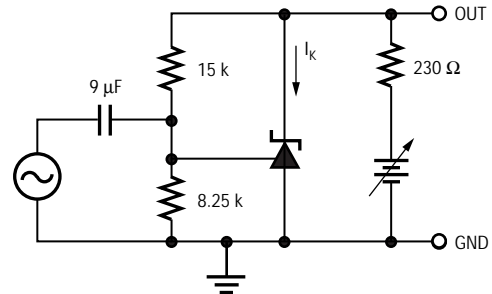
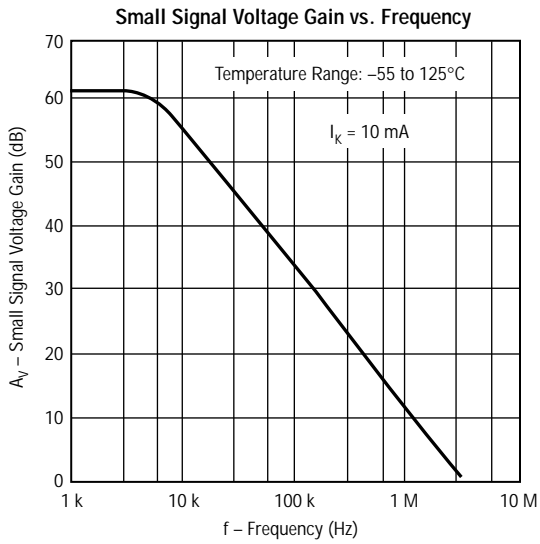

Figure 11

Typical Performance Curves

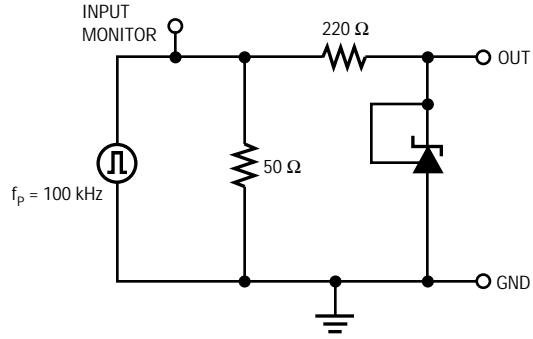
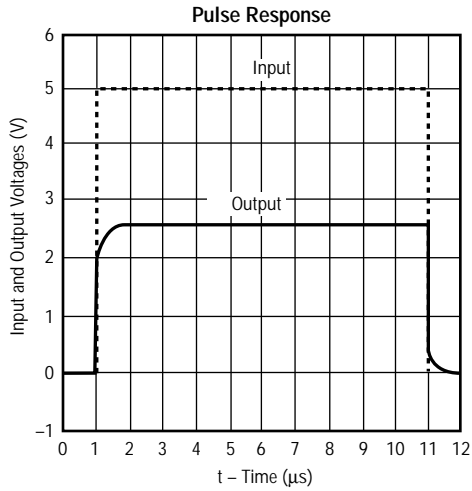

Figure 12

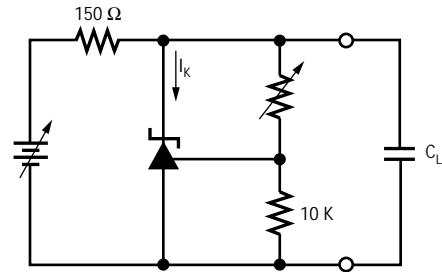
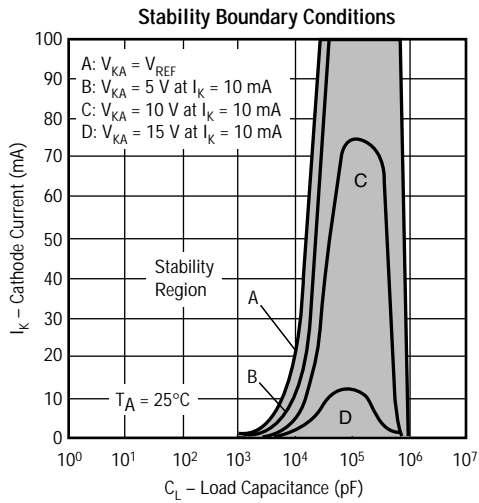

Figure 13