

Silicon NPN Power Transistors

2SC2577

DESCRIPTION

- With TO-3PN package
- Complement to type 2SA1102
- High power dissipation
- High current capability

APPLICATIONS

- Audio power amplifier
- DC-DC converter

PINNING

PIN	DESCRIPTION
1	Base
2	Collector;connected to mounting base
3	Emitter

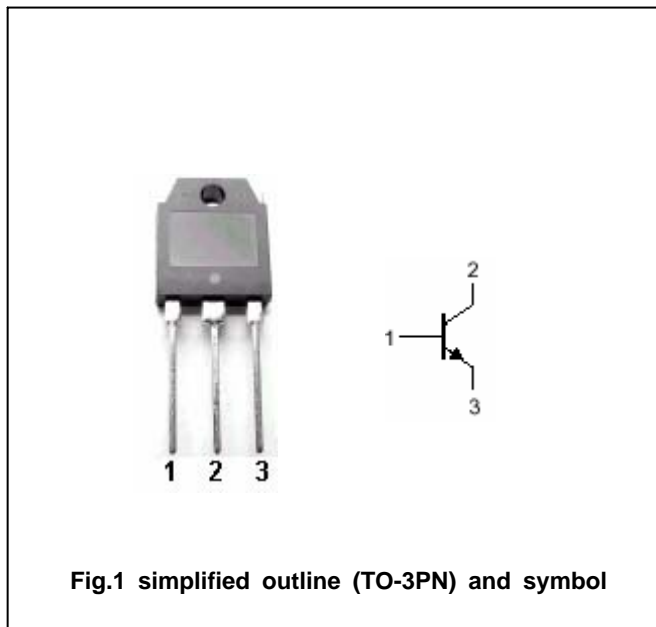

Fig.1 simplified outline (TO-3PN) and symbol

Absolute maximum ratings(Ta=)

SYMBOL	PARAMETER	CONDITIONS	VALUE	UNIT
V_{CBO}	Collector-base voltage	Open emitter	120	V
V_{CEO}	Collector-emitter voltage	Open base	80	V
V_{EBO}	Emitter-base voltage	Open collector	6	V
I_C	Collector current		6	A
P_C	Collector power dissipation	$T_C=25$	60	W
T_j	Junction temperature		150	
T_{stg}	Storage temperature		-55~150	

Silicon NPN Power Transistors

2SC2577

CHARACTERISTICS

T_j=25 unless otherwise specified

SYMBOL	PARAMETER	CONDITIONS	MIN	TYP.	MAX	UNIT
V _{(BR)CEO}	Collector-emitter breakdown voltage	I _C =25mA ; I _B =0	80			V
V _{(BR)CBO}	Collector-base breakdown voltage	I _C =1mA ; I _E =0	120			V
V _{(BR)EBO}	Emitter-base breakdown voltage	I _E =1mA ; I _C =0	6			V
V _{CEsat}	Collector-emitter saturation voltage	I _C =3A; I _B =0.3A			1.5	V
I _{CBO}	Collector cut-off current	V _{CB} =120V; I _E =0			100	μA
I _{EBO}	Emitter cut-off current	V _{EB} =6V; I _C =0			100	μA
h _{FE}	DC current gain	I _C =2A ; V _{CE} =4V	50			
f _T	Transition frequency	I _C =0.5A ; V _{CE} =10V		20		MHz

Silicon NPN Power Transistors

2SC2577

PACKAGE OUTLINE

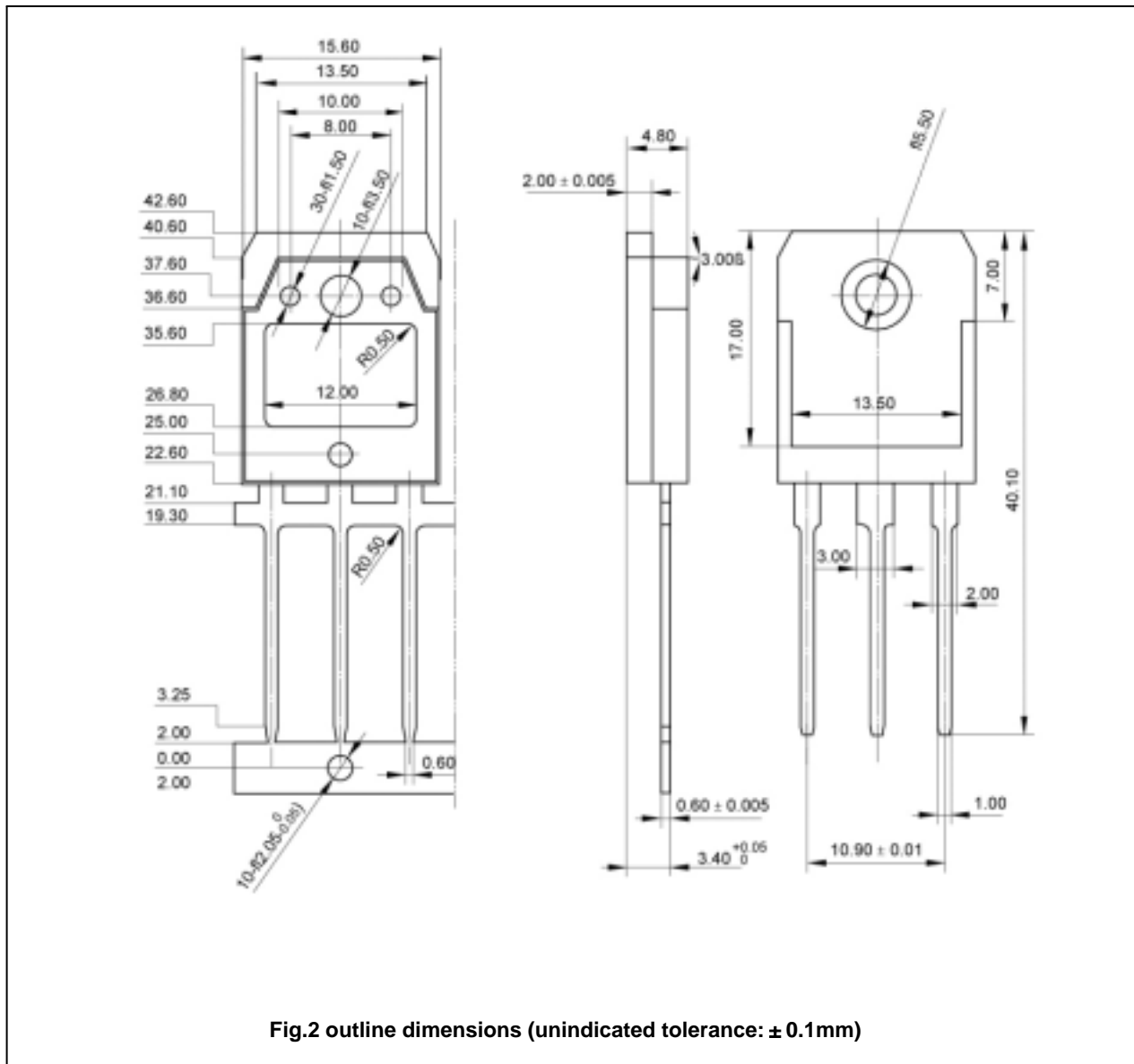

Fig.2 outline dimensions (unindicated tolerance: ± 0.1mm)