

To our customers,

Old Company Name in Catalogs and Other Documents

On April 1st, 2010, NEC Electronics Corporation merged with Renesas Technology Corporation, and Renesas Electronics Corporation took over all the business of both companies. Therefore, although the old company name remains in this document, it is a valid Renesas Electronics document. We appreciate your understanding.

Renesas Electronics website: <http://www.renesas.com>

April 1st, 2010
Renesas Electronics Corporation

Issued by: Renesas Electronics Corporation (<http://www.renesas.com>)

Send any inquiries to <http://www.renesas.com/inquiry>.

Not recommended
for new design

Notice

1. All information included in this document is current as of the date this document is issued. Such information, however, is subject to change without any prior notice. Before purchasing or using any Renesas Electronics products listed herein, please confirm the latest product information with a Renesas Electronics sales office. Also, please pay regular and careful attention to additional and different information to be disclosed by Renesas Electronics such as that disclosed through our website.
2. Renesas Electronics does not assume any liability for infringement of patents, copyrights, or other intellectual property rights of third parties by or arising from the use of Renesas Electronics products or technical information described in this document. No license, express, implied or otherwise, is granted hereby under any patents, copyrights or other intellectual property rights of Renesas Electronics or others.
3. You should not alter, modify, copy, or otherwise misappropriate any Renesas Electronics product, whether in whole or in part.
4. Descriptions of circuits, software and other related information in this document are provided only to illustrate the operation of semiconductor products and application examples. You are fully responsible for the incorporation of these circuits, software, and information in the design of your equipment. Renesas Electronics assumes no responsibility for any losses incurred by you or third parties arising from the use of these circuits, software, or information.
5. When exporting the products or technology described in this document, you should comply with the applicable export control laws and regulations and follow the procedures required by such laws and regulations. You should not use Renesas Electronics products or the technology described in this document for any purpose relating to military applications or use by the military, including but not limited to the development of weapons of mass destruction. Renesas Electronics products and technology may not be used for or incorporated into any products or systems whose manufacture, use, or sale is prohibited under any applicable domestic or foreign laws or regulations.
6. Renesas Electronics has used reasonable care in preparing the information included in this document, but Renesas Electronics does not warrant that such information is error free. Renesas Electronics assumes no liability whatsoever for any damages incurred by you resulting from errors in or omissions from the information included herein.
7. Renesas Electronics products are classified according to the following three quality grades: “Standard”, “High Quality”, and “Specific”. The recommended applications for each Renesas Electronics product depends on the product’s quality grade, as indicated below. You must check the quality grade of each Renesas Electronics product before using it in a particular application. You may not use any Renesas Electronics product for any application categorized as “Specific” without the prior written consent of Renesas Electronics. Further, you may not use any Renesas Electronics product for any application for which it is not intended without the prior written consent of Renesas Electronics. Renesas Electronics shall not be in any way liable for any damages or losses incurred by you or third parties arising from the use of any Renesas Electronics product for an application categorized as “Specific” or for which the product is not intended where you have failed to obtain the prior written consent of Renesas Electronics. The quality grade of each Renesas Electronics product is “Standard” unless otherwise expressly specified in a Renesas Electronics data sheets or data books, etc.
 - “Standard”: Computers; office equipment; communications equipment; test and measurement equipment; audio and visual equipment; home electronic appliances; machine tools; personal electronic equipment; and industrial robots.
 - “High Quality”: Transportation equipment (automobiles, trains, ships, etc.); traffic control systems; anti-disaster systems; anti-crime systems; safety equipment; and medical equipment not specifically designed for life support.
 - “Specific”: Aircraft; aerospace equipment; submersible repeaters; nuclear reactor control systems; medical equipment or systems for life support (e.g. artificial life support devices or systems), surgical implantations, or healthcare intervention (e.g. excision, etc.), and any other applications or purposes that pose a direct threat to human life.
8. You should use the Renesas Electronics products described in this document within the range specified by Renesas Electronics, especially with respect to the maximum rating, operating supply voltage range, movement power voltage range, heat radiation characteristics, installation and other product characteristics. Renesas Electronics shall have no liability for malfunctions or damages arising out of the use of Renesas Electronics products beyond such specified ranges.
9. Although Renesas Electronics endeavors to improve the quality and reliability of its products, semiconductor products have specific characteristics such as the occurrence of failure at a certain rate and malfunctions under certain use conditions. Further, Renesas Electronics products are not subject to radiation resistance design. Please be sure to implement safety measures to guard them against the possibility of physical injury, and injury or damage caused by fire in the event of the failure of a Renesas Electronics product, such as safety design for hardware and software including but not limited to redundancy, fire control and malfunction prevention, appropriate treatment for aging degradation or any other appropriate measures. Because the evaluation of microcomputer software alone is very difficult, please evaluate the safety of the final products or system manufactured by you.
10. Please contact a Renesas Electronics sales office for details as to environmental matters such as the environmental compatibility of each Renesas Electronics product. Please use Renesas Electronics products in compliance with all applicable laws and regulations that regulate the inclusion or use of controlled substances, including without limitation, the EU RoHS Directive. Renesas Electronics assumes no liability for damages or losses occurring as a result of your noncompliance with applicable laws and regulations.
11. This document may not be reproduced or duplicated, in any form, in whole or in part, without prior written consent of Renesas Electronics.
12. Please contact a Renesas Electronics sales office if you have any questions regarding the information contained in this document or Renesas Electronics products, or if you have any other inquiries.

(Note 1) “Renesas Electronics” as used in this document means Renesas Electronics Corporation and also includes its majority-owned subsidiaries.

(Note 2) “Renesas Electronics product(s)” means any product developed or manufactured by or for Renesas Electronics.

Preliminary

Notice: This is not final specification.
Some parametric limits are subject to change.

FEATURES

- Flow-Through Read mode, Single Late Write mode
- Fast access time: 7.5 ns and 8.5 ns
- Single 3.3V -5% and +5% power supply V_{DD}
- Separate V_{DDQ} for 3.3V or 2.5V I/O
- Individual byte write (BWA# - BWD#) controls may be tied LOW
- Single Read/Write control pin (W#)
- CKE# pin to enable clock and suspend operations
- Internally self-timed, registers outputs eliminate the need to control G#
- Snooze mode (ZZ) for power down
- Three chip enables for simple depth expansion

Package

100pin TQFP

APPLICATION

High-end networking products that require high bandwidth, such as switches and routers.

FUNCTION

Synchronous circuitry allows for precise cycle control triggered by a positive edge clock transition.

Synchronous signals include : all Addresses, all Data Inputs, all Chip Enables (E1#, E2, E3#), Address Advance/Load (ADV), Clock Enable (CKE#), Byte Write Enables (BWA#, BWB#, BWC#, BWD#) and Read/Write (W#).

Write operations are controlled by the four Byte Write Enables (BWA# - BWD#) and Read/Write(W#) inputs. All writes are conducted with on-chip synchronous self-timed write circuitry.

Asynchronous inputs include Output Enable (G#), Clock (CLK) and Snooze Enable (ZZ).

The HIGH input of ZZ pin puts the SRAM in the power-down state.

All read, write and deselect cycles are initiated by the ADV LOW input. Subsequent burst address can be internally generated as controlled by the ADV HIGH input.

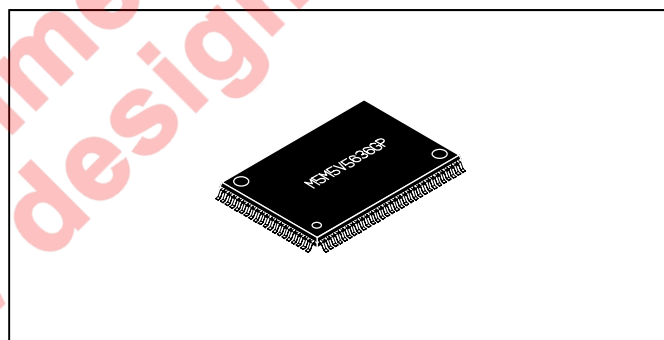
**PART NAME TABLE**

Part Name	Access	Cycle	Active Current (max.)	Standby Current (max.)
M5M5V5A36GP-75	7.5ns	8.5ns	280mA	30mA
M5M5V5A36GP-85	8.5ns	10ns	260mA	30mA

Renesas LSIs
M5M5V5A36GP-75,85

18874368-BIT(524288-WORD BY 36-BIT) Flow-Through NETWORK SRAM

PIN CONFIGURATION(TOP VIEW)

100pin TQFP

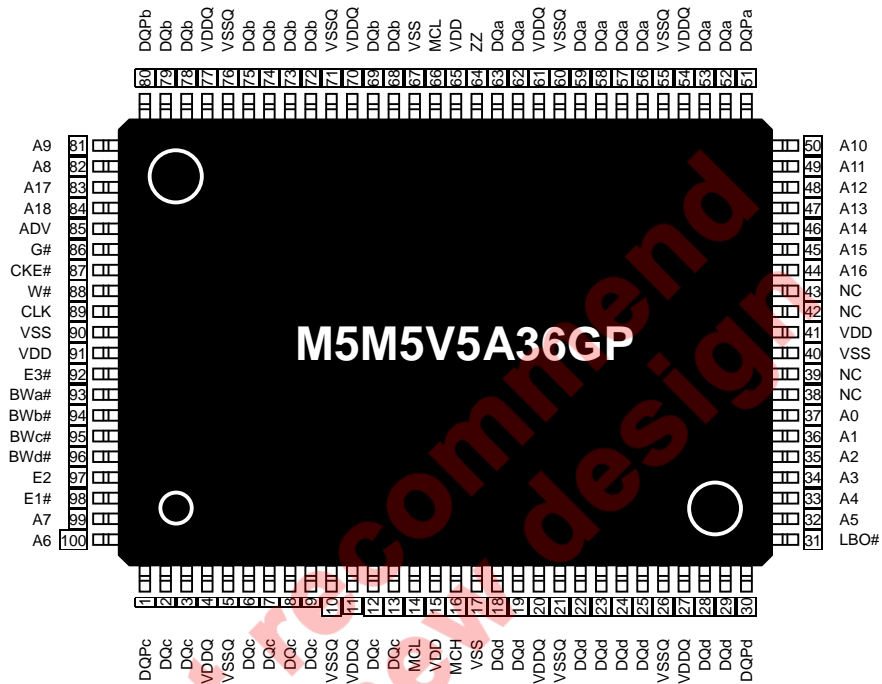

Note1. MCH means "Must Connect High". MCH should be connected to HIGH.
 Note2. MCL means "Must Connect Low". MCL should be connected to LOW.

Renesas LSIs
M5M5V5A36GP-75,85

18874368-BIT(524288-WORD BY 36-BIT) Flow-Through NETWORK SRAM

BLOCK DIAGRAM

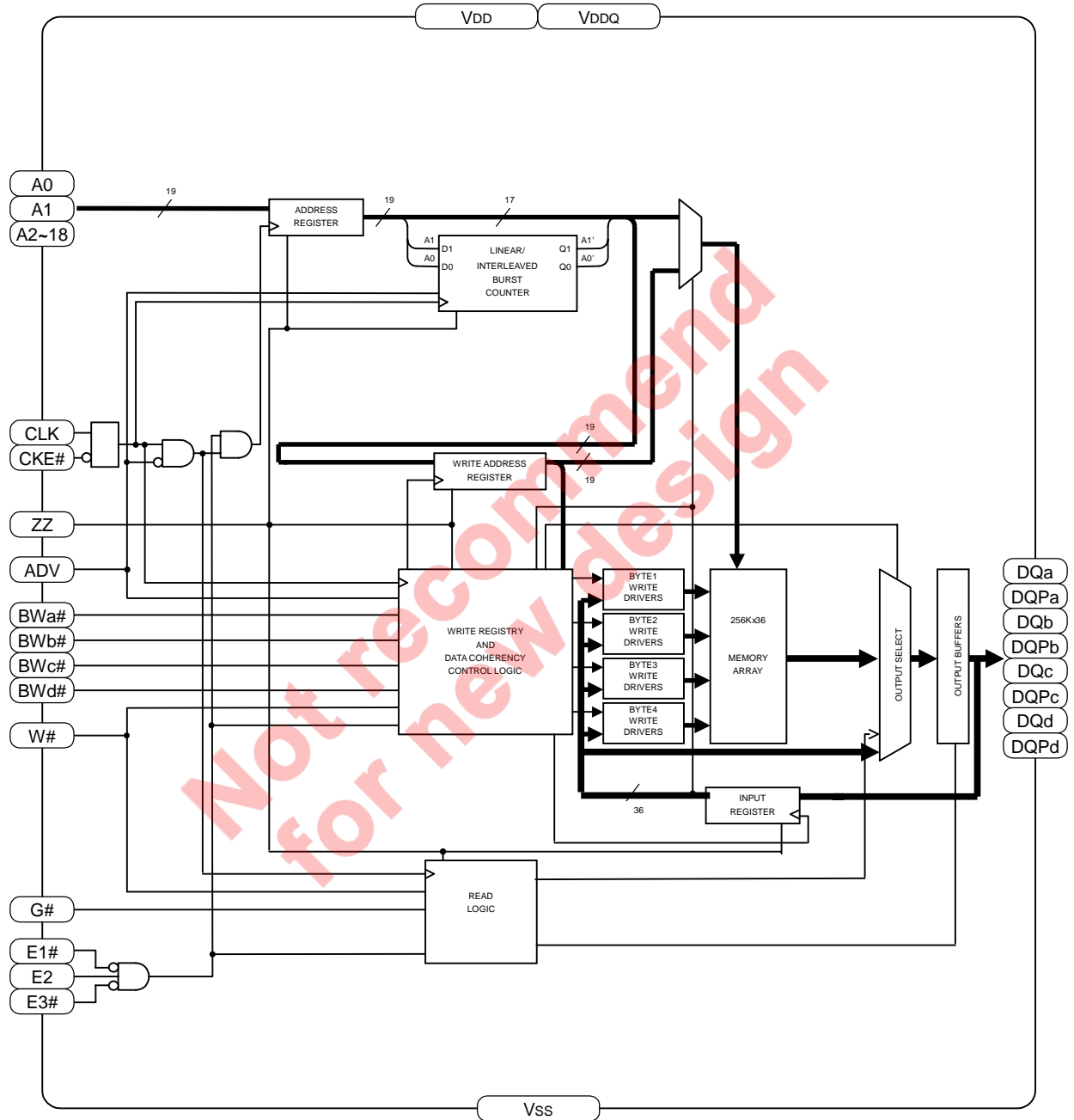

Note3. The BLOCK DIAGRAM illustrates simplified device operation. See TRUTH TABLE, PIN FUNCTION and timing diagrams for detailed information.

Renesas LSIs
M5M5V5A36GP-75,85

18874368-BIT(524288-WORD BY 36-BIT) Flow-Through NETWORK SRAM

PIN FUNCTION

Pin	Name	Function
A0~A18	Synchronous Address Inputs	These inputs are registered and must meet the setup and hold times around the rising edge of CLK. A0 and A1 are the two least significant bits (LSB) of the address field and set the internal burst counter if burst is desired.
BWa#, BWb#, BWc#, BWd#	Synchronous Byte Write Enables	These active LOW inputs allow individual bytes to be written when a WRITE cycle is active and must meet the setup and hold times around the rising edge of CLK. BYTE WRITES need to be asserted on the same cycle as the address. BWs are associated with addresses and apply to subsequent data. BWa# controls DQa, DQP a pins; BWb# controls DQb, DQP b pins; BWc# controls DQc, DQP c pins; BWd# controls DQd, DQP d pins.
CLK	Clock Input	This signal registers the address, data, chip enables, byte write enables and burst control inputs on its rising edge. All synchronous inputs must meet setup and hold times around the clock's rising edge.
E1#	Synchronous Chip Enable	This active LOW input is used to enable the device and is sampled only when a new external address is loaded (ADV is LOW).
E2	Synchronous Chip Enable	This active High input is used to enable the device and is sampled only when a new external address is loaded (ADV is LOW). This input can be used for memory depth expansion.
E3#	Synchronous Chip Enable	This active Low input is used to enable the device and is sampled only when a new external address is loaded (ADV is LOW). This input can be used for memory depth expansion.
G#	Output Enable	This active LOW asynchronous input enable the data I/O output drivers.
ADV	Synchronous Address Advance/Load	When HIGH, this input is used to advance the internal burst counter, controlling burst access after the external address is loaded. When HIGH, W# is ignored. A LOW on this pin permits a new address to be loaded at CLK rising edge.
CKE#	Synchronous Clock Enable	This active LOW input permits CLK to propagate throughout the device. When HIGH, the device ignores the CLK input and effectively internally extends the previous CLK cycle. This input must meet setup and hold times around the rising edge of CLK.
LBO#	Burst Mode Control	This DC operated pin allows the choice of either an interleaved burst or a linear burst. If this pin is HIGH or NC, an interleaved burst occurs. When this pin is LOW, a linear burst occurs, and input leak current to this pin.
ZZ	Snooze Enable	This active HIGH asynchronous input causes the device to enter a low-power standby mode in which all data in the memory array is retained. When active, all other inputs are ignored. When this pin is LOW or NC, the SRAM normally operates.
W#	Synchronous Read/Write	This active input determines the cycle type when ADV is LOW. This is the only means for determining READs and WRITEs. READ cycles may not be converted into WRITEs (and vice versa) other than by loading a new address. A LOW on the pin permits BYTE WRITE operations and must meet the setup and hold times around the rising edge of CLK. Full bus width WRITEs occur if all byte write enables are LOW.
DQa,DQP a,DQb,DQP b,DQc,DQP c,DQd,DQP d	Synchronous Data I/O	Byte "a" is DQa , DQP a pins; Byte "b" is DQb, DQP b pins; Byte "c" is DQc, DQP c pins; Byte "d" is DQd,DQP d pins. Input data must meet setup and hold times around CLK rising edge.
VDD	VDD	Core Power Supply
VSS	VSS	Core Ground
VDDQ	VDDQ	I/O buffer Power supply
VSSQ	VSSQ	I/O buffer Ground
MCH	Must Connect High	These pins should be connected to HIGH
MCL	Must Connect Low	These pins should be connected to LOW
NC	No Connect	These pins are not internally connected and may be connected to ground.

Read Operations Flow-Through Read

Read operation is initiated when the following conditions are satisfied at the rising edge of clock: All three chip enables (E1#, E2 and E3#) are active, the write enable input signal (W#) is deasserted high, and ADV is asserted low.

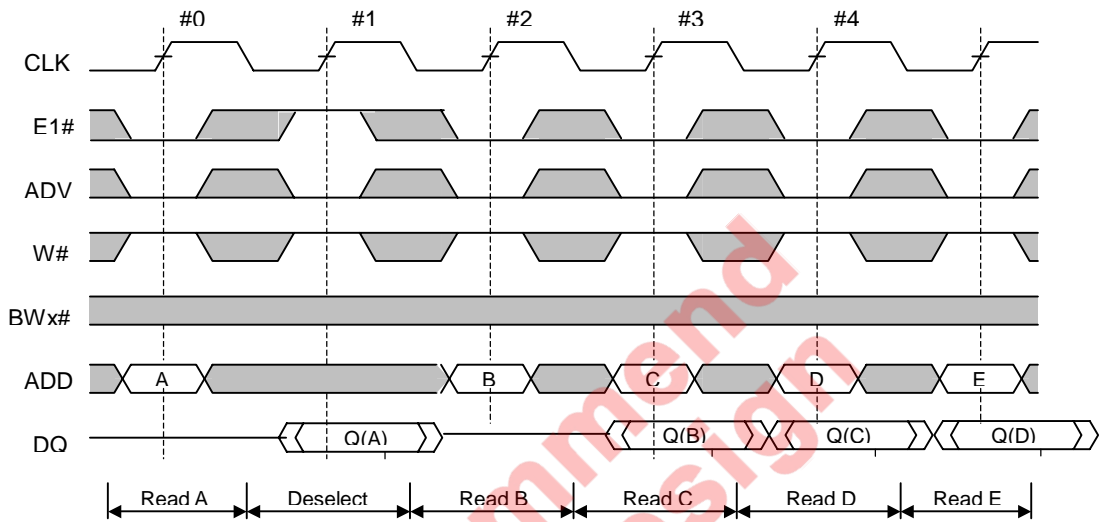

Write Operation Single Late Write

Write operation occurs when the following conditions are satisfied at the rising edge of clock: All three chip enables (E1#, E2 and E3#) are active, the write enable input signal (W#) is asserted low, and ADV is asserted low.

In Single Late Write the RAM requires Data in one rising clock edge later than the edge used to load Address and Control.

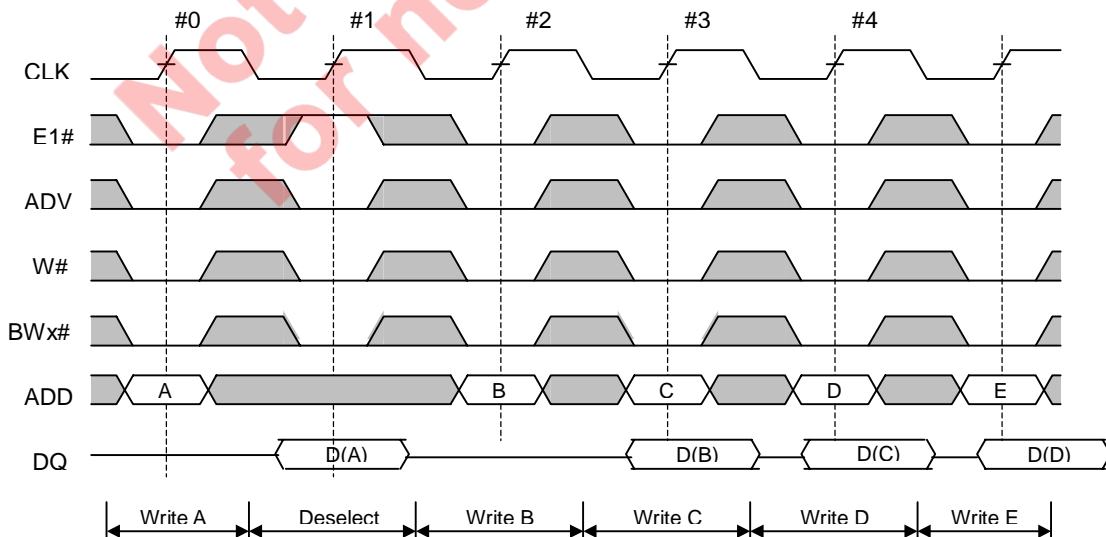

Single Late Write with Flow-Through Read

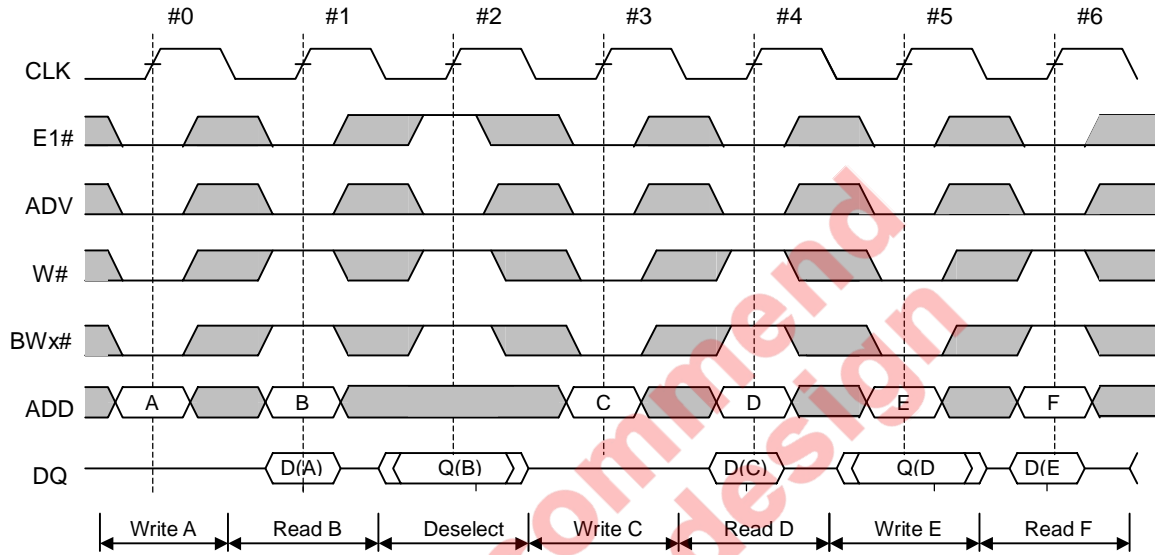

Not recommended for new designs

Renesas LSIs
M5M5V5A36GP-75,85

18874368-BIT(524288-WORD BY 36-BIT) Flow-Through NETWORK SRAM

DC OPERATED TRUTH TABLE

Name	Input Status	Operation
LBO#	HIGH or NC	Interleaved Burst Sequence
	LOW	Linear Burst Sequence

Note4. LBO# is DC operated pin.

Note5. NC means No Connection.

Note6. See BURST SEQUENCE TABLE about interleaved and Linear Burst Sequence.

BURST SEQUENCE TABLE

Interleaved Burst Sequence (when LBO# = HIGH or NC)

Operation	A18~A2	A1,A0			
First access, latch external address	A18~A2	0, 0	0, 1	1, 0	1, 1
Second access(first burst address)	latched A18~A2	0, 1	0, 0	1, 1	1, 0
Third access(second burst address)	latched A18~A2	1, 0	1, 1	0, 0	0, 1
Fourth access(third burst address)	latched A18~A2	1, 1	1, 0	0, 1	0, 0

Linear Burst Sequence

Operation	A18~A2	A1,A0			
First access, latch external address	A18~A2	0, 0	0, 1	1, 0	1, 1
Second access(first burst address)	latched A18~A2	0, 1	1, 0	1, 1	0, 0
Third access(second burst address)	latched A18~A2	1, 0	1, 1	0, 0	0, 1
Fourth access(third burst address)	latched A18~A2	1, 1	0, 0	0, 1	1, 0

Note7. The burst sequence wraps around to its initial state upon completion.

TRUTH TABLE

E1#	E2	E3#	ZZ	ADV	W#	BWx#	G#	CKE#	CLK	DQ	Address used	Operation
H	X	X	L	L	X	X	X	L	L->H	High-Z	None	Deselect Cycle
X	L	X	L	L	X	X	X	L	L->H	High-Z	None	Deselect Cycle
X	X	H	L	L	X	X	X	L	L->H	High-Z	None	Deselect Cycle
X	X	X	L	H	X	X	X	L	L->H	High-Z	None	Continue Deselect Cycle
L	H	L	L	L	H	X	L	L	L->H	Q	External	Read Cycle, Begin Burst
X	X	X	L	H	X	X	L	L	L->H	Q	Next	Read Cycle, Continue Burst
L	H	L	L	L	H	X	H	L	L->H	High-Z	External	NOP/Dummy Read, Begin Burst
X	X	X	L	H	X	X	H	L	L->H	High-Z	Next	Dummy Read, Continue Burst
L	H	L	L	L	L	L	X	L	L->H	D	External	Write Cycle, Begin Burst
X	X	X	L	H	X	L	X	L	L->H	D	Next	Write Cycle, Continue Burst
L	H	L	L	L	L	H	X	L	L->H	High-Z	None	NOP/Write Abort, Begin Burst
X	X	X	L	H	X	H	X	L	L->H	High-Z	Next	Write Abort, Continue Burst
X	X	X	L	X	X	X	X	H	L->H	-	Current	Ignore Clock edge, Stall
X	X	X	H	X	X	X	X	X	X	High-Z	None	Snooze Mode

Note8. "H" = input VIH; "L" = input VIL; "X" = input VIH or VIL.

Note9. BWx#=H means all Synchronous Byte Write Enables (BWa#,BWb#,BWc#,BWd#) are HIGH. BWx#=L means one or more Synchronous Byte Write Enables are LOW.

Note10. All inputs except G# and ZZ must meet setup and hold times around the rising edge (LOW to HIGH) of CLK.

STATE DIAGRAM

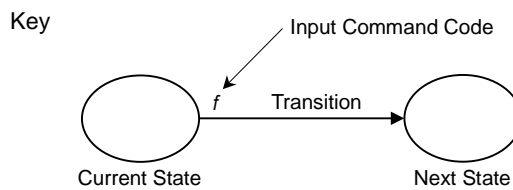
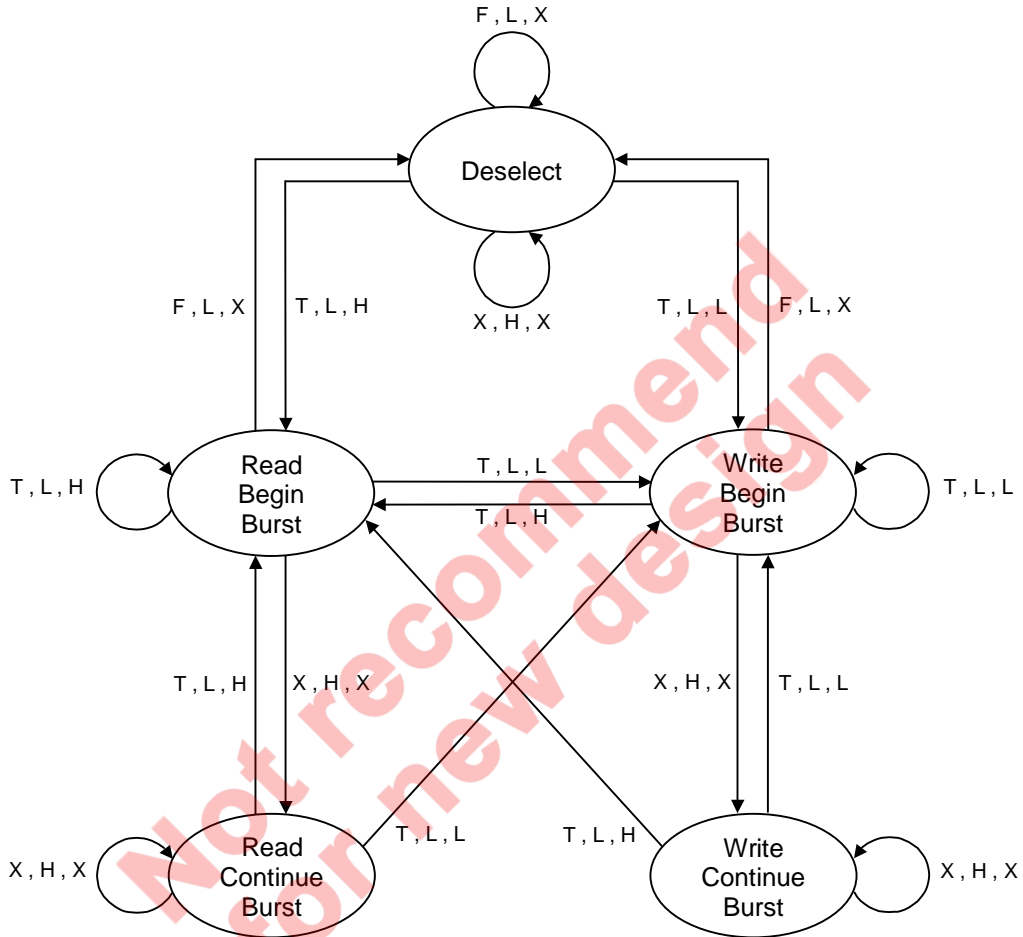

Note11. The notation "x , x , x" controlling the state transitions above indicate the state of inputs E, ADV and W# respectively.

Note12. If (E1# = L and E2 = H and E3# = L) then E="T" else E="F".

Note13. "H" = input VIH; "L" = input VIL; "X" = input VIH or VIL; "T" = input "true"; "F" = input "false".

WRITE TRUTH TABLE

W#	BWa#	BWb#	BWc#	BWd#	Function
H	X	X	X	X	Read
L	L	H	H	H	Write Byte a
L	H	L	H	H	Write Byte b
L	H	H	L	H	Write Byte c
L	H	H	H	L	Write Byte d
L	L	L	L	L	Write All Bytes
L	H	H	H	H	Write Abort/NOP

Note14. "H" = input VIH; "L" = input VIL; "X" = input VIH or VIL.

Note15. All inputs except G# and ZZ must meet setup and hold times around the rising edge (LOW to HIGH) of CLK.

ABSOLUTE MAXIMUM RATINGS

Symbol	Parameter	Conditions	Ratings	Unit
VDD	Power Supply Voltage	With respect to Vss	-1.0*~4.6	V
VDDQ	I/O Buffer Power Supply Voltage		-1.0*~4.6	V
VI	Input Voltage		-1.0~VDDQ+1.0**	V
VO	Output Voltage		-1.0~VDDQ+1.0**	V
PD	Maximum Power Dissipation (VDD)		1180	mW
TOPR	Operating Temperature		0~70	°C
TSTG(bias)	Storage Temperature(bias)		-10~85	°C
TSTG	Storage Temperature		-65~150	°C

Note16.* This is -1.0V when pulse width≤2ns, and -0.5V in case of DC.

** This is -1.0V~VDDQ+1.0V when pulse width≤2ns, and -0.5V~VDDQ+0.5V in case of DC.

CAPACITANCE

Symbol	Parameter	Conditions	Limits			Unit
			Min	Typ	Max	
CI	Input Capacitance	VI=GND, VI=25mVrms, f=1MHz			6	pF
CO	Input / Output(DQ) Capacitance	Vo=GND, Vo=25mVrms, f=1MHz			8	pF

Note19.This parameter is sampled.

THERMAL RESISTANCE

4-Layer PC board mounted (70x70x1.6mmT)

Symbol	Parameter	Conditions	Limits			Unit
			Min	Typ	Max	
θJA	Thermal Resistance Junction Ambient	Air velocity=0m/sec		28		°C/W
		Air velocity=2m/sec		20		°C/W
θJC	Thermal Resistance Junction to Case			6.6		°C/W

Note20.This parameter is sampled.

Renesas LSIs
M5M5V5A36GP-75,85

18874368-BIT(524288-WORD BY 36-BIT) Flow-Through NETWORK SRAM

DC ELECTRICAL CHARACTERISTICS (Ta=0~70°C, VDD=3.135~3.465V, unless otherwise noted)

Symbol	Parameter	Condition	Limits		Unit
			Min	Max	
VDD	Power Supply Voltage		3.135	3.465	V
VDDQ	I/O Buffer Power Supply Voltage	VDDQ = 3.3V	3.135	3.465	V
		VDDQ = 2.5V	2.375	2.625	
VIH	High-level Input Voltage	VDDQ = 3.135~3.465V	2.0	VDDQ+0.3*	V
		VDDQ = 2.375~2.625V	1.7		
VIL	Low-level Input Voltage	VDDQ = 3.135~3.465V	-0.3*	0.8	V
		VDDQ = 2.375~2.625V		0.7	
VOH	High-level Output Voltage	IOH = -2.0mA	VDDQ-0.4		V
VOL	Low-level Output Voltage	IOL = 2.0mA		0.4	V
ILI	Input Current except ZZ and LBO#	VI = 0V ~ VDDQ		10	μA
	Input Current of LBO#	VI = 0V ~ VDDQ		100	
	Input Current of ZZ	VI = 0V ~ VDDQ		100	
ILO	Off-state Output Current	VI (G#) ≥ VIH, VO = 0V ~ VDDQ		10	μA
ICC1	Power Supply Current : Operating	Device selected; Output Open VI ≤ VIL or VI ≥ VIH ZZ ≤ VIL	-75(Cycle time=8.5ns)	280	mA
			-85(Cycle time=10ns)	260	
ICC2	Power Supply Current : Deselected	Device deselected VI ≤ VIL or VI ≥ VIH ZZ ≤ VIL	-75(Cycle time=8.5ns)	90	mA
			-85(Cycle time=10ns)	80	
ICC3	CMOS Standby Current (CLK stopped standby mode)	Device deselected; Output Open VI ≤ VSS+0.2V or VI ≥ VDDQ-0.2V CLK frequency=0Hz, All inputs static		30	mA
ICC4	Snooze Mode Standby Current	Snooze mode ZZ ≥ VDDQ-0.2V		30	mA
ICC5	Stall Current	Device selected; Output Open CKE# ≥ VIH VI ≤ VSS+0.2V or VI ≥ VDDQ-0.2V	-75(Cycle time=8.5ns)	80	mA
			-85(Cycle time=10ns)	70	

Note17.*VILmin is -1.0V and VIHmax is VDDQ+1.0V in case of AC(Pulse width≤2ns).

Note18."Device Deselected" means device is in power-down mode as defined in the truth table.

AC ELECTRICAL CHARACTERISTICS (Ta=0~70°C, VDD=3.135~3.465V, unless otherwise noted)

(1) MEASUREMENT CONDITION

- Input pulse levels $V_{IH}=V_{DDQ}$, $V_{IL}=0V$
- Input rise and fall times faster than or equal to 1V/ns
- Input timing reference levels $V_{IH}=V_{IL}=0.5 \cdot V_{DDQ}$
- Output reference levels $V_{IH}=V_{IL}=0.5 \cdot V_{DDQ}$
- Output load Fig.1

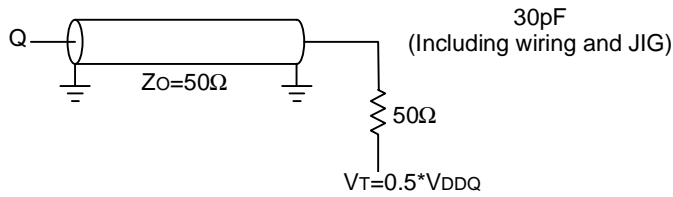

Fig.1 Output load

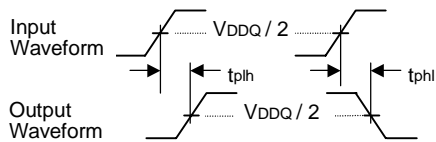

Fig.2 Tdly measurement

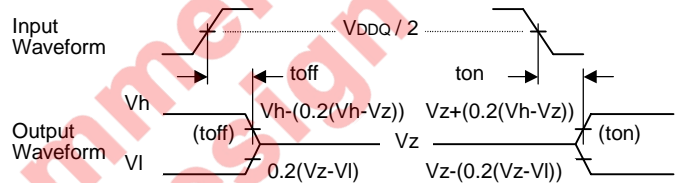

Fig.3 Tri-State measurement

Note21. Valid Delay Measurement is made from the $V_{DDQ}/2$ on the input waveform to the $V_{DDQ}/2$ on the output waveform.

Input waveform should have a slew rate of faster than or equal to 1V/ns.

Note22. Tri-state toff measurement is made from the $V_{DDQ}/2$ on the input waveform to the output waveform moving 20% from its initial to final Value $V_{DDQ}/2$.

Note: the initial value is not V_{OL} or V_{OH} as specified in DC ELECTRICAL CHARACTERISTICS table.

Note23. Tri-state ton measurement is made from the $V_{DDQ}/2$ on the input waveform to the output waveform moving 20% from its initial Value $V_{DDQ}/2$ to its final Value.

Note: the final value is not V_{OL} or V_{OH} as specified in DC ELECTRICAL CHARACTERISTICS table.

Note24. Clocks, Data, Address and control signals will be tested with a minimum input slew rate of faster than or equal to 1V/ns.

Renesas LSIs
M5M5V5A36GP-75,85

18874368-BIT(524288-WORD BY 36-BIT) Flow-Through NETWORK SRAM

(2)TIMING CHARACTERISTICS

Symbol	Parameter	Limits				Unit
		-75		-85		
		Min	Max	Min	Max	
Clock						
tKHKH	Clock Cycle time	8.5		10		ns
tKHKL	Clock HIGH time	2.8		3.0		ns
tKLKH	Clock LOW time	2.8		3.0		ns
Output times						
tKHQV	Clock HIGH to output valid		7.5		8.5	ns
tKHQX	Clock HIGH to output invalid	2.5		2.5		ns
tKHQX1	Clock HIGH to output in LOW-Z	2.5		2.5		ns
tKHQZ	Clock HIGH to output in High-Z		4.0		5.0	ns
tGLQV	G# to output valid		3.5		4.0	ns
tGLQX1	G# to output in Low-Z	0.0		0.0		ns
tGHQZ	G# to output in High-Z		3.5		4.0	ns
Setup times						
tAVKH	Address valid to clock HIGH	2.0		2.0		ns
tckeVKH	CKE# valid to clock HIGH	2.0		2.0		ns
tadvVKH	ADV valid to clock HIGH	2.0		2.0		ns
tWVKH	Write valid to clock HIGH	2.0		2.0		ns
tBVKH	Byte write valid to clock HIGH (BWA#~BWD#)	2.0		2.0		ns
tEVKH	Enable valid to clock HIGH (E1#,E2,E3#)	2.0		2.0		ns
tDVKH	Data In valid to clock HIGH	2.0		2.0		ns
Hold times						
tKHAX	Clock HIGH to Address don't care	0.5		0.5		ns
tKHckeX	Clock HIGH to CKE# don't care	0.5		0.5		ns
tKHadvX	Clock HIGH to ADV don't care	0.5		0.5		ns
tKH WX	Clock HIGH to Write don't care	0.5		0.5		ns
tKHBX	Clock HIGH to Byte Write don't care (BWA#~BWb#)	0.5		0.5		ns
tKH EX	Clock HIGH to Enable don't care (E1#,E2,E3#)	0.5		0.5		ns
tKHDX	Clock HIGH to Data In don't care	0.5		0.5		ns
ZZ						
tZZS	ZZ standby		2*tKHKH		2*tKHKH	ns
tZZREC	ZZ recovery		2*tKHKH		2*tKHKH	ns

Note25.All parameter except tZZS, tZZREC in this table are measured on condition that ZZ=LOW fix.

Note26.Test conditions is specified with the output loading shown in Fig.1 unless otherwise noted.

Note27. tKHQX1, tKHQZ, tGLQX1, tGHQZ are sampled.

Note28.LBO# is static and must not change during normal operation.

(3)READ TIMING

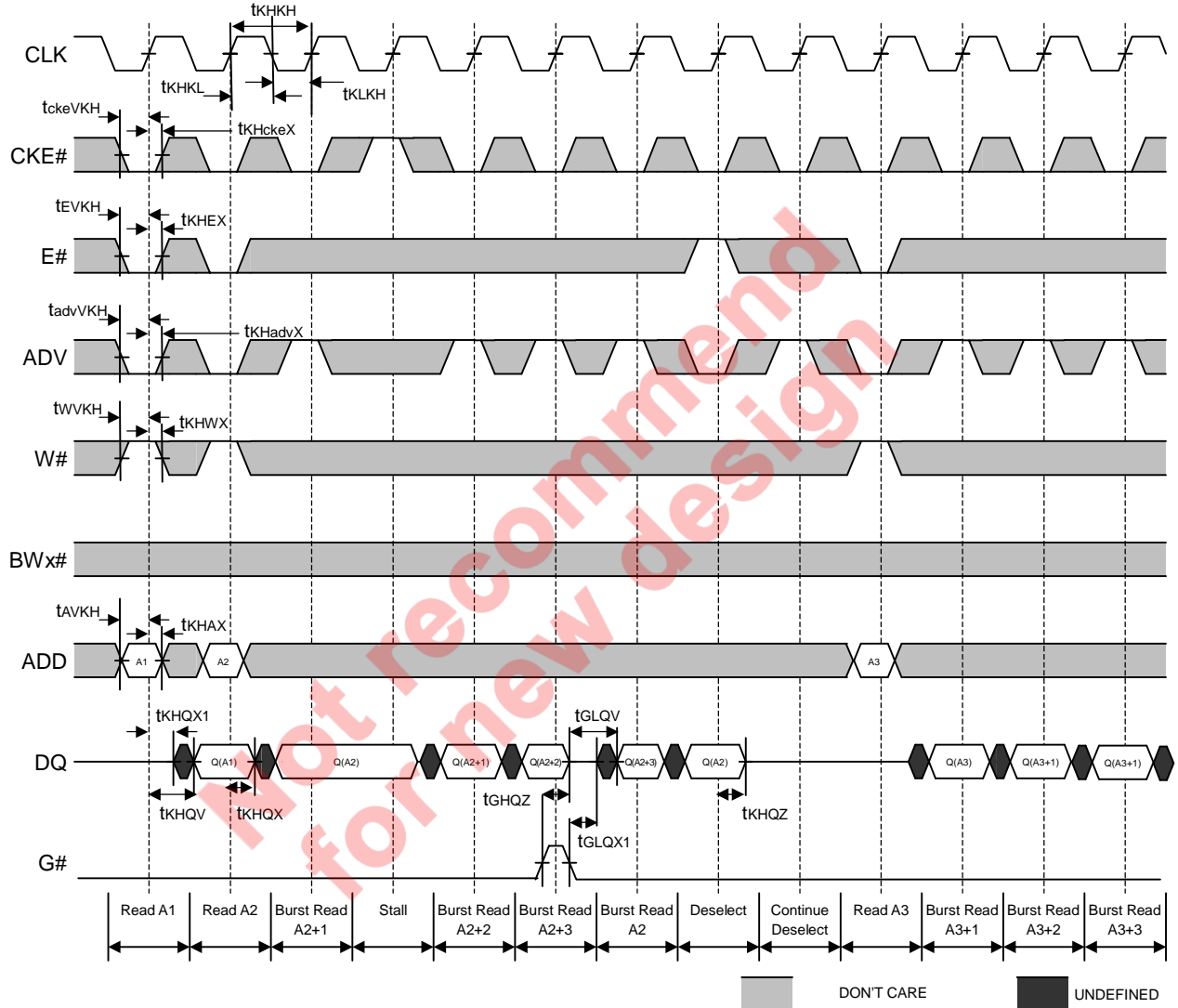

Note29. Q(An) refers to output from address An. Q(An+1) refers to output from the next internal burst address following An.

Note30. E# represents three signals. When E# is LOW, it represents E1# is LOW, E2 is HIGH and E3# is LOW.

Note31. ZZ is fixed LOW.

(5) READ/WRITE TIMING

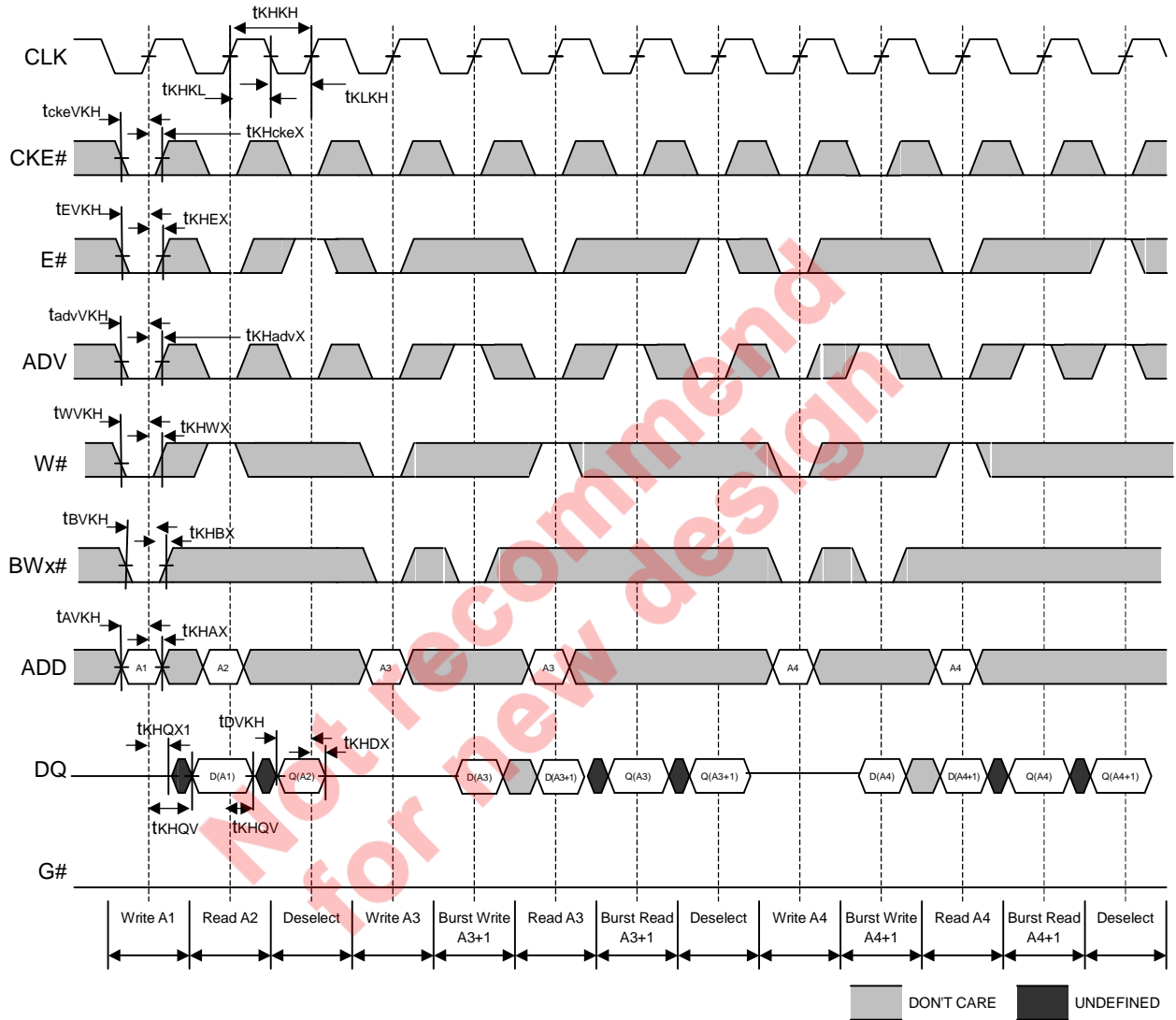

Note35.Q(A_n) refers to output from address A_n. Q(A_{n+1}) refers to output from the next internal burst address following A_n.

Note36. E# represents three signals. When E# is LOW, it represents E1# is LOW, E2 is HIGH and E3# is LOW.

Note37.ZZ is fixed LOW.

(6)SNOOZE MODE TIMING

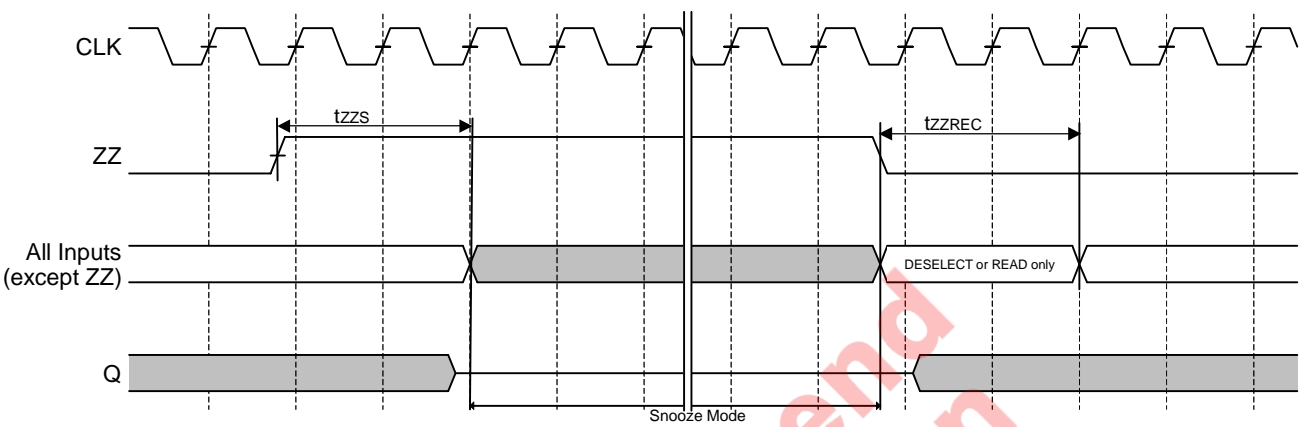

Renesas LSIs
M5M5V5A36GP-75,85

18874368-BIT(524288-WORD BY 36-BIT) Flow-Through NETWORK SRAM

PACKAGE OUTLINE

Plastic 100pin 14x20 mm body

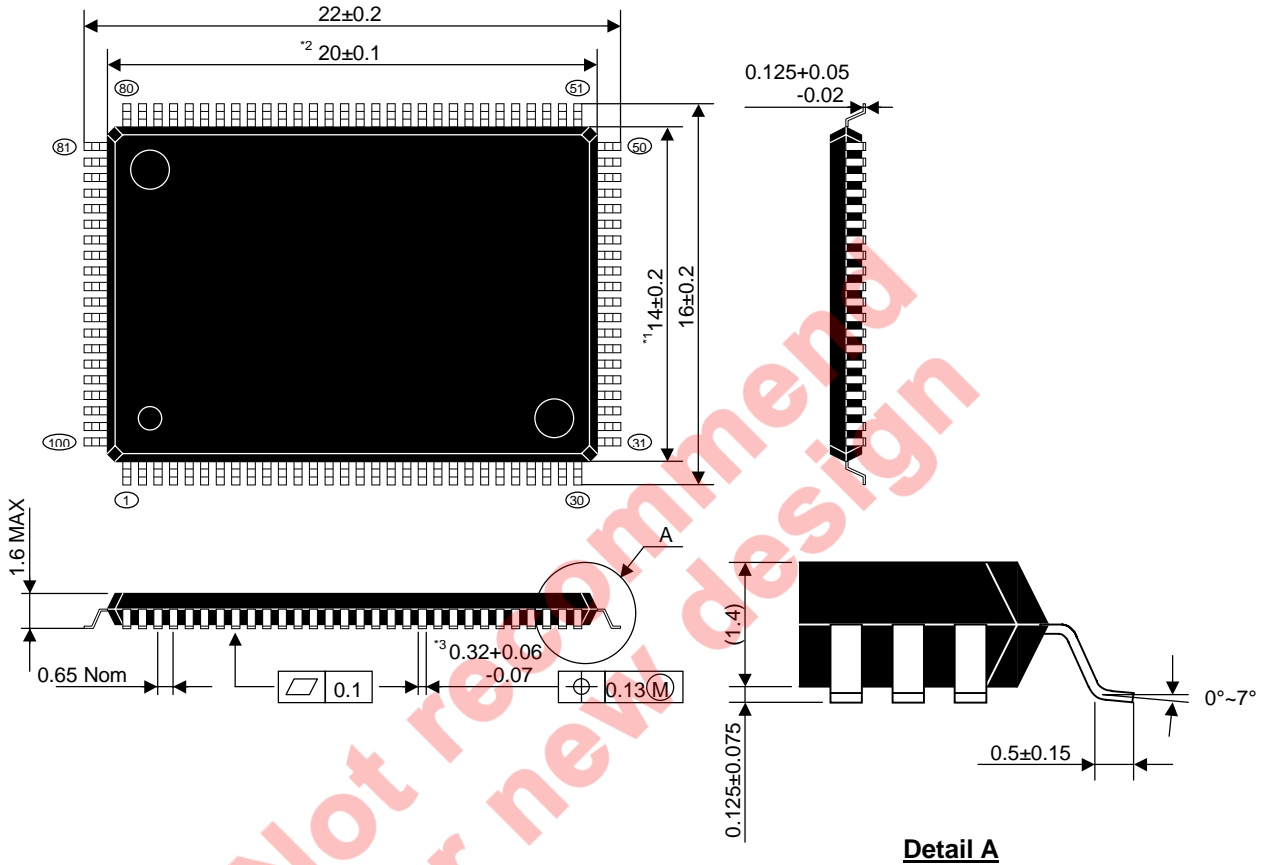

Note38. Dimensions *1 and *2 don't include mold flash.
 Note39 Dimension *3 doesn't include trim off set.
 Note40. All dimensions in millimeters.

Renesas LSIs
M5M5V5A36GP-75,85

18874368-BIT(524288-WORD BY 36-BIT) Flow-Through NETWORK SRAM

REVISION HISTORY

Rev. No.	History	Date	
0.0	First revision	November 20, 2002	Preliminary
0.1	DC ELECTRICAL CHARACTERISTICS Changed ILI limit from 10uA to 100uA (Input Leakage Current of ZZ and LBO#) Changed Icc3 and Icc4 limit from 20mA to 30mA (Standby Current)	January 31, 2003	Preliminary
1.0	The semiconductor operations of HITACHI and MITSUBISHI Electric were transferred to RENESAS Technology Corporation on April 1st 2003.	August 1, 2003	Preliminary

Not recommend
for new design

Renesas LSIs
M5M5V5A36GP-75,85

18874368-BIT(524288-WORD BY 36-BIT) Flow-Through NETWORK SRAM

Not recommend
for new design

Renesas Technology Corp.

Nippon Bldg.,6-2,Oteamchi 2-chome,Chiyoda-ku,Tokyo,100-0004 Japan

Keep safety first in your circuit designs!

- Renesas Technology Corporation puts the maximum effort into making semiconductor products better and more reliable, but there is always the possibility that trouble may occur with them. Trouble with semiconductors may lead to personal injury, fire or property damage. Remember to give due consideration to safety when making your circuit designs, with appropriate measures such as (i) placement of substitutive, auxiliary circuits, (ii) use of nonflammable material or (iii) prevention against any malfunction or mishap.

Notes regarding these materials

- These materials are intended as a reference to assist our customers in the selection of the Renesas Technology Corporation product best suited to the customer's application; they do not convey any license under any intellectual property rights, or any other rights, belonging to Renesas Technology Corporation or a third party.
- Renesas Technology Corporation assumes no responsibility for any damage, or infringement of any third-party's rights, originating in the use of any product data, diagrams, charts, programs, algorithms, or circuit application examples contained in these materials.
- All information contained in these materials, including product data, diagrams, charts, programs and algorithms represents information on products at the time of publication of these materials, and are subject to change by Renesas Technology Corporation without notice due to product improvements or other reasons. It is therefore recommended that customers contact Renesas Technology Corporation or an authorized Renesas Technology Corporation product distributor for the latest product information before purchasing a product listed herein.
The information described here may contain technical inaccuracies or typographical errors.
Renesas Technology Corporation assumes no responsibility for any damage, liability, or other loss rising from these inaccuracies or errors.
Please also pay attention to information published by Renesas Technology Corporation by various means, including the Renesas Technology Corporation Semiconductor home page (<http://www.renesas.com>).
- When using any or all of the information contained in these materials, including product data, diagrams, charts, programs, and algorithms, please be sure to evaluate all information as a total system before making a final decision on the applicability of the information and products. Renesas Technology Corporation assumes no responsibility for any damage, liability or other loss resulting from the information contained herein.
- Renesas Technology Corporation semiconductors are not designed or manufactured for use in a device or system that is used under circumstances in which human life is potentially at stake. Please contact Renesas Technology Corporation or an authorized Renesas Technology Corporation product distributor when considering the use of a product contained herein for any specific purposes, such as apparatus or systems for transportation, vehicular, medical, aerospace, nuclear, or undersea repeater use.
- The prior written approval of Renesas Technology Corporation is necessary to reprint or reproduce in whole or in part these materials.
- If these products or technologies are subject to the Japanese export control restrictions, they must be exported under a license from the Japanese government and cannot be imported into a country other than the approved destination.
Any diversion or reexport contrary to the export control laws and regulations of Japan and/or the country of destination is prohibited.
- Please contact Renesas Technology Corporation for further details on these materials or the products contained therein.

REJ03C0073

© 2003 Renesas Technology Corp.
New publication, effective August 2003.
Specifications subject to change without notice.

RENESAS
Renesas Technology Corp.