

BASIC FUNCTION AUDIO PROCESSOR

- TWO STEREO AND ONE MONO INPUTS
- MUTE FUNCTION (SOFTWARE AND HARDWARE) CONTROLLED
- VOLUME CONTROL IN 1dB STEP
- BASS AND TREBLE CONTROL
- FOUR SPEAKER ATTENUATORS:
 - Independent attenuation control
 - Independent mute function
- ALL FUNCTIONS PROGRAMMABLE VIA I²C BUS
- FULLY PROGRAMMABLE LOUDNESS CONTROL

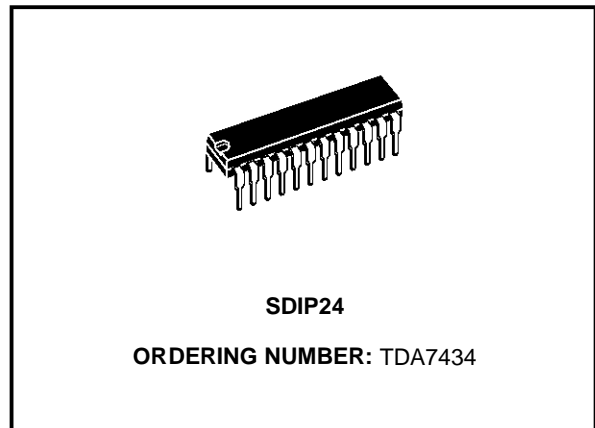

DESCRIPTION

The TDA7434 is a volume, tone (bass and treble) balance (Left / Right) fader (Front / Rear) processor for quality audio applications in car radio and Hi-Fi systems.

Control is accomplished by serial bus microprocessor interface.

The AC signal setting is obtained by resistor networks and switches combined with operational amplifiers.

Thanks to the advanced BIPOLAR/CMOS Technology, the external components have been reduced.

BLOCK DIAGRAM

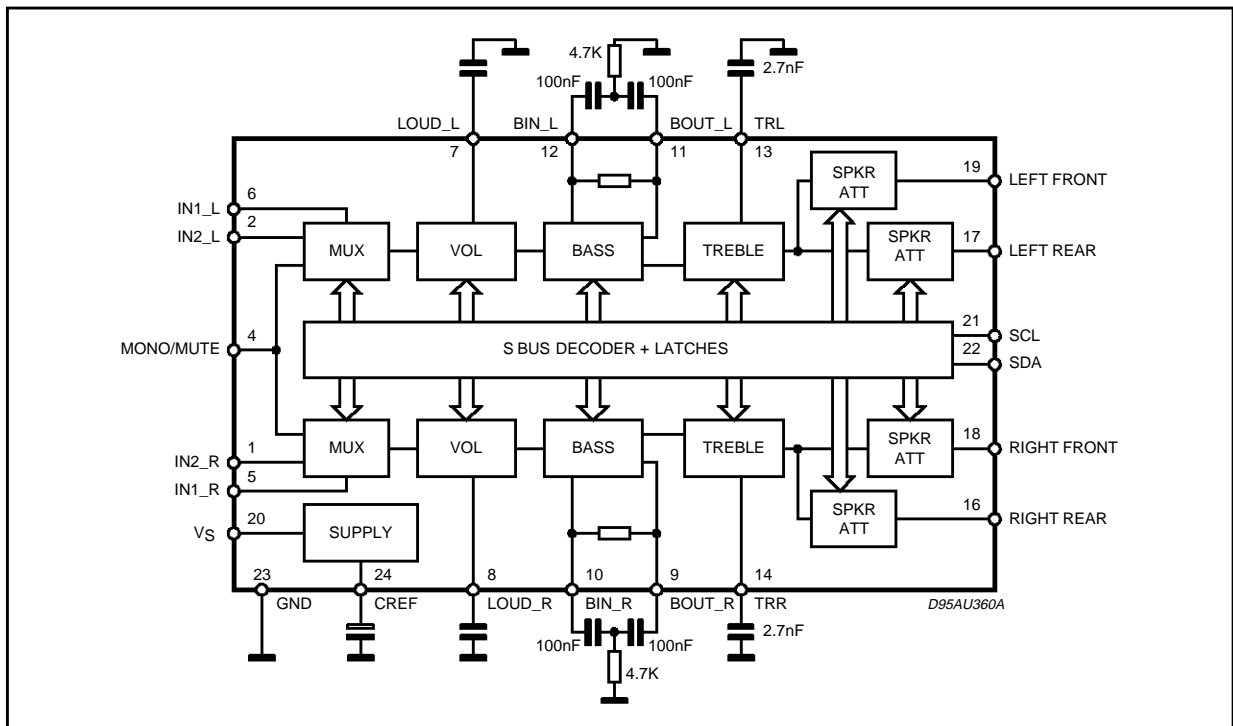

TDA7434

ABSOLUTE MAXIMUM RATINGS

Symbol	Parameter	Value	Unit
V _S	Operating Supply Voltage	10.2	V
T _{amb}	Operating Temperature Range	-40 to 85	°C
T _{stg}	Storage Temperature Range	-55 to +150	°C

QUICK REFERENCE DATA

Symbol	Parameter	Min.	Typ.	Max.	Unit
V _S	Supply Voltage	7	9	10.2	V
V _{CL}	Max. Input Signal Handling	1.3	1.6		V _{rms}
THD	Total Harmonic Distortion (V = 1V _{rms} f = 1kHz)		0.05		%
S/N	Signal to Noise Ratio		102		dB
Sc	Channel Separation f = 1kHz		100		dB
	Volume Control 1dB step	-79		+32	dB
	Bass Control 2dB step	-18		+18	dB
	Treble Control 2dB step	-14		+14	dB
	Speaker Attenuators	-37.5		0	dB
	Mute Attenuation		100		dB

PIN CONNECTION (Top View)

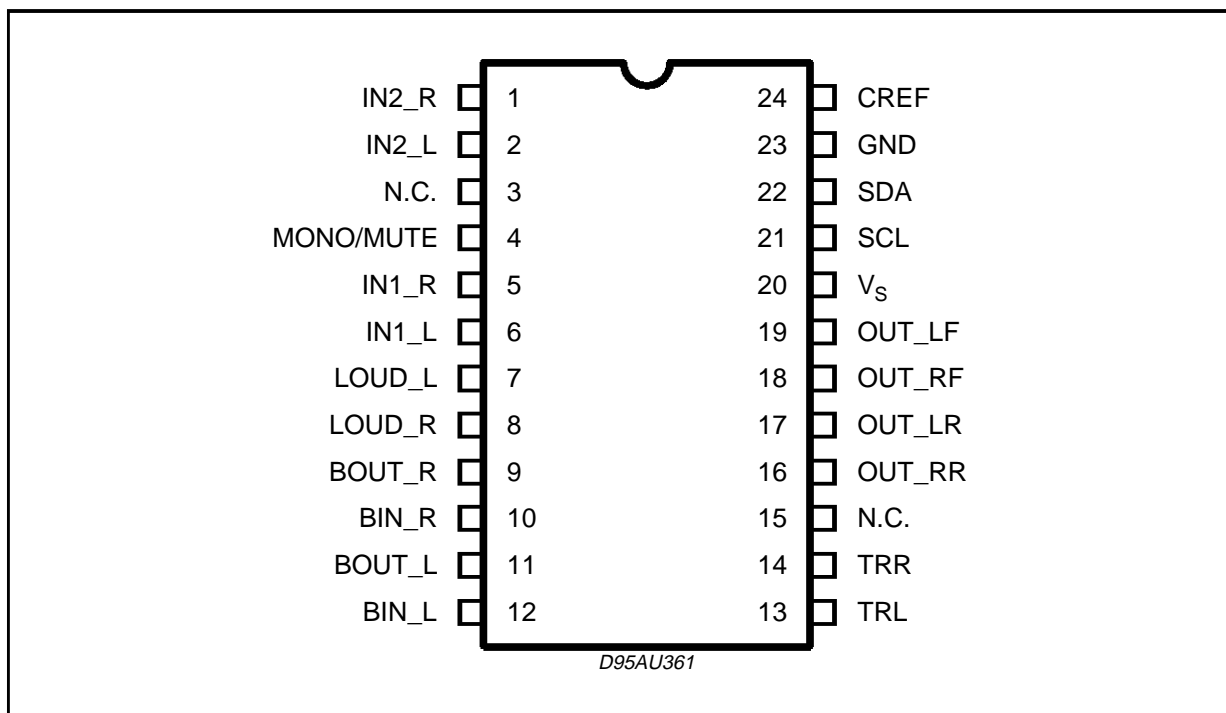

THERMAL DATA

Symbol	Parameter	Value	Unit
R _{thj-pins}	Thermal Resistance Junction-pins	Max. 65	°C/W

APPLICATION CIRCUIT

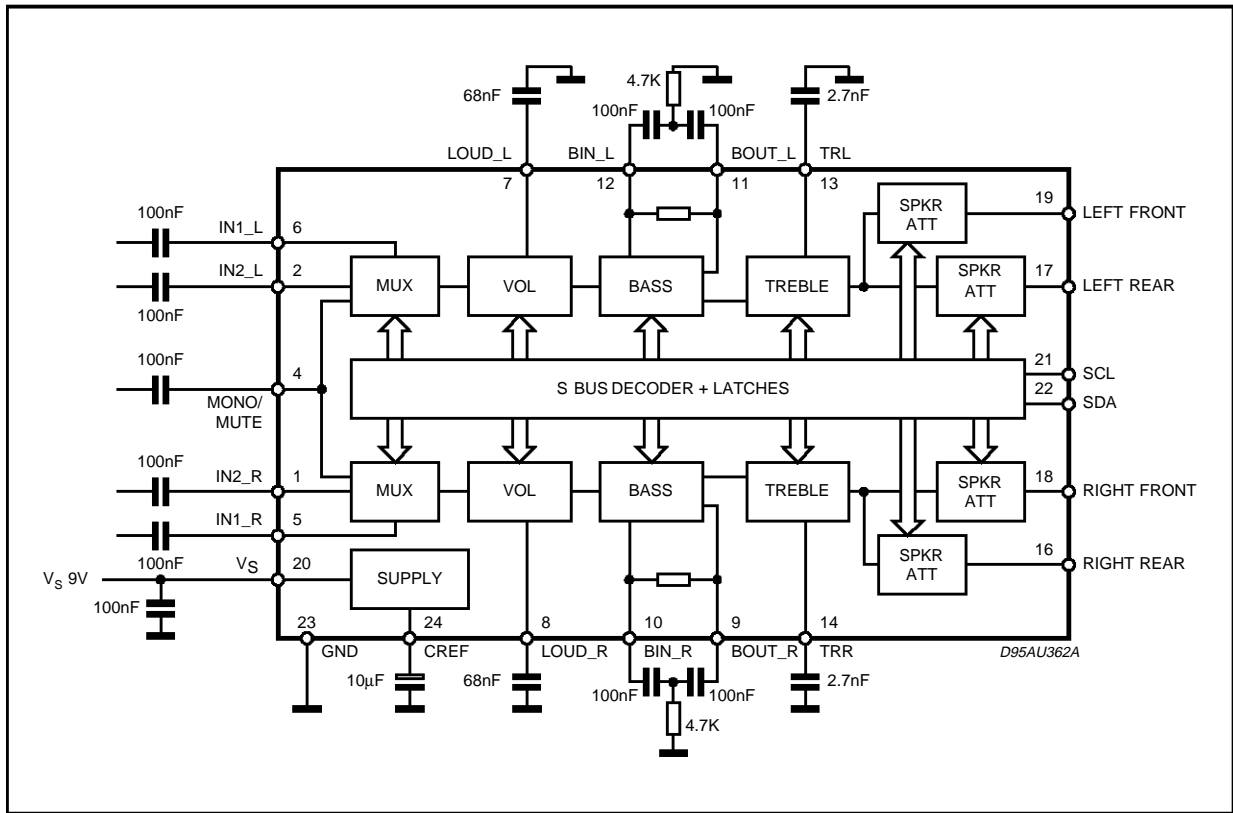

TDA7434

ELECTRICAL CHARACTERISTICS ($T_{amb} = 25^{\circ}\text{C}$, $V_S = 9\text{V}$, $R_L = 10\text{k}\Omega$, $R_G = 50\Omega$, all variable gains = 0dB, $f = 1\text{kHz}$, unless otherwise specified.)

Symbol	Parameter	Test Condition	Min.	Typ.	Max.	Unit
INPUT SELECTOR						
R_{IN}	Input Resistance		70	100	130	$\text{k}\Omega$
V_{CL}	Clipping Level	$d \leq 0.3\%$	1.3	1.6		V _{rms}
S_{IN}	Input Separation		70	90		dB
A_{MUTE}	Input Mute Attenuation		70	95		dB
V_{DC}	Mute DC Step			0.2	10	mV
MUTE AT AM INPUT (*)						
V_{IL}	Input Low Voltage	AM not selected			0.4	V
VOLUME CONTROL						
G_{MAX}	Max. Gain	Note 2	30.5	32	33.5	dB
A_{MAX}	Max Attenuation		75	79	83	dB
A_{step}	Step Resolution		0.5	1	1.5	dB
E_A	Attenuation Set Error	$G = +20$ to -20dB	-1	0	+1	dB
		$G = -20$ to -60dB	-2		2	dB
E_T	Tracking Error	$G = +20$ to -60dB			2	dB
V_{DC}	DC Steps	Adjacent Attenuation Steps, Range from 0 to -79dB		0.1	4	mV
		From 0dB to -79dB		0.5	10	mV
LOUDNESS CONTROL						
A_{MAX}	Control Range		14	15	16	dB
A_{step}	Step Resolution		0.5	1	1.5	dB
R_{LOUD}	Internal Resistor		37	50	63	$\text{k}\Omega$
BASS CONTROL						
B_{RANGE}	Max. Bass boost		15.5	+18	20	dB
B_{CUT}	Max. Bass cut		-20	-18	-15.5	dB
A_{step}	Step Resolution		1	2	3	dB
R_B	Internal Feedback Resistance		48	65	82	$\text{k}\Omega$
TREBLE CONTROL						
C_{RANGE}	Control Range		± 13	± 14	± 15	dB
A_{step}	Step Resolution		1	2	3	dB
SPEAKER ATTENUATORS						
C_{RANGE}	Control Range		36	37.5	39	dB
A_{step}	Step Resolution	From 0 to -24dB	0.5	1	1.5	dB
A_{MUTE}	Output Mute Attenuation		70	90		dB
E_A	Attenuation Set Error	From 0 to -24dB			1	dB
V_{DC}	DC Steps	Adjacent Attenuation Steps		0.1	4	mV
AUDIO OUTPUTS						
V_{CLIP}	Clipping Level	$d = 0.3\%$	2	2.5		V _{rms}
G_{OUT}	Output Gain (fixed)		3.5	4	4.5	dB
R_L	Output Load Resistance	AC - connected	3			$\text{k}\Omega$
		DC connected to GND	5			
C_L	Output Load Capacitance				10	nF
R_{OUT}	Output Impedance			30	100	Ω
V_{DC}	DC Voltage Level		3.7	4.0	4.3	V

(*) The mute function can be activated without using the I2C bus by grounding the AM input when AM is not selected. This causes the input multiplexer to select the reference voltage instead of an input signal.

ELECTRICAL CHARACTERISTICS (continued)

Symbol	Parameter	Test Condition	Min.	Typ.	Max.	Unit
GENERAL						
V _S	Supply Voltage		6	9	10.2	V
I _S	Supply Current		5	8	11	mA
PSRR	Power Supply Rejection Ratio		65	85		dB
e _{NO}	Output Noise	20Hz - 20kHz "A" - weighted BW = 200Hz - 20kHz, flat output muted		4 7.0 5.5	20	μV μV μV
S/N	Signal to Noise Ratio	all gains = 0dB; V _O = 1Vrms		103		dB
d	Distortion	V _{OUT} = 1Vrms		0.04	0.15	%
Sc	Channel Separation		70	80		dB
E _T	Total Tracking Error	A _V = 0 to -20dB A _V = -20 to -60dB		0 0	1 2	dB dB
BUS INPUTS						
V _{IL}	Input Low Voltage				1	V
V _{IH}	Input High Voltage		3			V
I _{IN}	Input Current	V _{IN} = 0.4V	-5		+5	μA
V _O	Output Voltage SDA Acknowledge	I _O = 1.6mA		0.15	0.40	V

SOFTWARE SPECIFICATION**Interface Protocol**

The interface protocol comprises:

- a start condition (S)
- a chip address byte (the LSB bit determines read / write transmission)
- a subaddress byte
- a sequence of data (N-bytes + acknowledge)
- a stop condition (P)

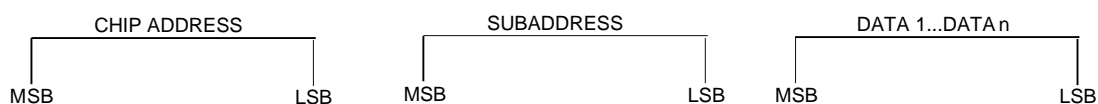

S	1	0	0	0	1	0	1	R/W	ACK	X	X	X	I	A ₃	A ₂	A ₁	A ₀	ACK				DATA				ACK	P
---	---	---	---	---	---	---	---	-----	-----	---	---	---	---	----------------	----------------	----------------	----------------	-----	--	--	--	------	--	--	--	-----	---

ACK = Acknowledge

S = Start

P = Stop

MAX CLOCK SPEED 500kbits/s

Auto Increment

If bit I in the subaddress byte is set to "1", the autoincrement of the subaddress is enabled.

TDA7434

SUBADDRESS (receive mode)

MSB				LSB				FUNCTION
X	X	X	I	A3	A2	A1	A0	
				0	0	0	0	Input selector
				0	0	0	1	Volume
				0	0	1	0	Bass, Treble
				0	0	1	1	Speaker attenuator LF
				0	1	0	0	Speaker attenuator LR
				0	1	0	1	Speaker attenuator RF
				0	1	1	0	Speaker attenuator RR
				0	1	1	1	Loudness

I = Auto increment

X = Not used

DATA BYTE SPECIFICATION

X = not relevant; set to "1" during testing

Input Selector

MSB				LSB				FUNCTION
D7	D6	D5	D4	D3	D2	D1	D0	
					0	0	0	IN 2
					0	0	1	IN 1
					0	1	0	mono
					0	1	1	no input selected
					1	X	X	mute (low homic)
			0	0				non-symmetrical bass cut (note 1)
			1	1				symmetrical bass cut
			0					extended bass range
			1					standard bass range ± 14 dB

For example to select the MONO input the Data Byte is: X X X X X 0 1 0.

An additional direct mute function is included in the Speaker Attenuators.

Note 1: Bass cut for very low frequencies.

MSB				LSB				VOLUME
D7(*)	D6	D5	D4	D3	D2	D1	D0	
1	0	0	0					+32dB
1	0	0	1					+16dB
1	0	1	0					0dB
1	0	1	1					-16dB
1	1	0	0					-32dB
1	1	0	1					-48dB
1	1	1	0					-64dB
1				0	0	0	0	0dB
1				0	0	0	1	-1dB
1				0	0	1	0	-2dB
1				1	1	1	1	-15dB

(*) Loudness = ON

Note 2:

It is not recommended to use a gain more than 20dB for system performance reason. In general, the max. gain should be limited by software to the maximum value, which is needed for the system.

Bass, Treble

	MSB				LSB				FUNCTION
	D ₇	D ₆	D ₅	D ₄	D ₃	D ₂	D ₁	D ₀	
					0	0	0	0	Treble Steps
					0	0	0	1	-14dB
					0	0	1	0	-12dB
					0	0	1	1	-10dB
					0	1	0	0	-8dB
					0	1	0	1	-6dB
					0	1	1	0	-4dB
					0	1	1	1	-2dB
					1	1	1	1	0dB
					1	1	1	0	0dB
					1	1	0	1	+2dB
					1	1	0	0	+4dB
					1	1	0	0	+6dB
					1	0	1	1	+8dB
					1	0	1	0	+10dB
					1	0	0	1	+12dB
					1	0	0	0	+14dB
D4 Input Selector									Bass Steps
0	0	0	0	1					-18dB
0	0	0	0	0					-16dB
1	0	0	0	0					-14dB
1	0	0	0	1					-12dB
1	0	0	1	0					-10dB
1	0	0	1	1					-8dB
1	0	1	0	0					-6dB
1	0	1	0	1					-4dB
1	0	1	1	0					-2dB
1	0	1	1	1					0dB
1	1	1	1	1					0dB
1	1	1	1	0					+2dB
1	1	1	0	1					+4dB
1	1	1	0	0					+6dB
1	1	0	1	1					+8dB
1	1	0	1	0					+10dB
1	1	0	0	1					+12dB
1	1	0	0	0					+14dB
0	1	0	0	0					+16dB
0	1	0	0	1					+18dB

For example 12dB Treble and -8dB Bass give the following DATA BYTE: 0 0 1 1 1 0 0 1

Speaker Attenuators

MSB				LSB				SPEAKER ATTENUATOR LF, LR, RF, RR
D ₇	D ₆	D ₅	D ₄	D ₃	D ₂	D ₁	D ₀	
X	X	0	0	0	0	0	0	0dB
X	X	0	0	0	0	0	1	-1dB
			:					:
X	X	0	1	1	0	0	0	-24dB
X	X	0	1	1	0	0	1	-25.5dB
X	X	0	1	1	0	1	0	-27dB
X	X	0	1	1	0	1	1	-28.5dB
X	X	0	1	1	1	0	0	-30dB
X	X	0	1	1	1	1	1	-32dB
X	X	0	1	1	1	1	0	-34.5dB
X	X	0	1	1	1	1	1	-37.5dB
X	X	1	X	X	X	X	X	Speaker Mute

Loudness

MSB				LSB				LOUDNESS
D ₇	D ₆	D ₅	D ₄	D ₃	D ₂	D ₁	D ₀	
X	X	X	0	0	0	0	0	0dB
X	X	X	0	0	0	0	1	-1dB
X	X	X	0	0	0	1	0	-2dB
X	X	X	0	0	0	1	1	-3dB
X	X	X	0	0	1	0	0	-4dB
X	X	X	0	0	1	0	1	-5dB
X	X	X	0	0	1	1	0	-6dB
X	X	X	0	0	1	1	1	-7dB
X	X	X	0	1	0	0	0	-8dB
X	X	X	0	1	0	0	1	-9dB
X	X	X	0	1	0	1	0	-10dB
X	X	X	0	1	0	1	1	-11dB
X	X	X	0	1	1	0	0	-12dB
X	X	X	0	1	1	0	1	-13dB
X	X	X	0	1	1	1	0	-14dB
X	X	X	0	1	1	1	1	-15dB
X	X	X	1	D ₃	D ₂	D ₁	D ₀	Loudness flat (Note 3)

For example to select -14dB Loudness the Data Byte is : X X X 0 1 1 1 0.

Note 3:

Flat attenuation, according to the selected byte. The loudness can be completely disabled by setting bit D7 in the volume byte to "0". In this case the attenuation is 0dB independent from the loudness settings.

Functional Description

The input selector is able to select 2 stereo inputs and 1 mono input (AM). The inputs are DC biased with a 100kΩ resistors to the internal reference voltage of 3V. The AM input can be used additionally as hardware mute pin. If this pin is pulled to ground by an external transistors and AM is not selected, the input selector mutes the input (reference voltage selected). The AM part is considered to be switched OFF. If the output of the AM part is not high ohmic in this condition, a series resistor of about 20kΩ has to be foreseen.

The volume control can be programmed from a gain of +32dB to an attenuation of -79dB in 1dB steps. The maximum gain should be kept as low as possible for system performance reason. It has to be limited by software to the absolute necessary system gain, depending on the signal source level and the power amplifier gain.

The bass control acts in a range from +18dB to -18dB in 2dB steps. The filter response is deter-

mined by the external filter components. An extensive simulation software is available in order to support the design of the bass filter response with different filter configurations.

The extended bass boost range of +18dB allows the implementation of the software loudness function by additional bass and treble boost.

The treble control acts in a range of ±14dB in 2dB steps. The external capacitor determines with the internal resistor of 50kΩ the corner frequency of the treble response.

The four speaker attenuators can be controlled independently from 0 to -37.5dB, which allows the implementation of balance and fader for a four speaker system. The attenuation steps size is 1 db from 0 to -24dB and increases nonlinearly up to the maximum attenuation of 37.5dB. A special mute bit forces the speaker attenuator into the mute position.

All 4 outputs are low distortion push pull outputs, able to drive a load of 3kΩ.

SDIP24 PACKAGE MECHANICAL DATA

DIM.	mm			inch		
	MIN.	TYP.	MAX.	MIN.	TYP.	MAX.
A			5.08			0.20
A1	0.51			0.020		
A2	3.05	3.30	4.57	0.120	0.130	0.180
B	0.36	0.46	0.56	0.0142	0.0181	0.0220
B1	0.76	1.02	1.14	0.030	0.040	0.045
c	0.23	0.25	0.38	0.0090		0.0150
D	22.61	22.86	23.11	0.890	0.90	0.910
E	7.62		8.64	0.30		0.340
E1	6.10	6.40	6.86	0.240	0.252	0.270
e		1.778			0.070	
e1		7.62			0.30	
e2			10.92			0.430
e3			1.52			0.060
L	2.54	3.30	3.81	0.10	0.130	0.150

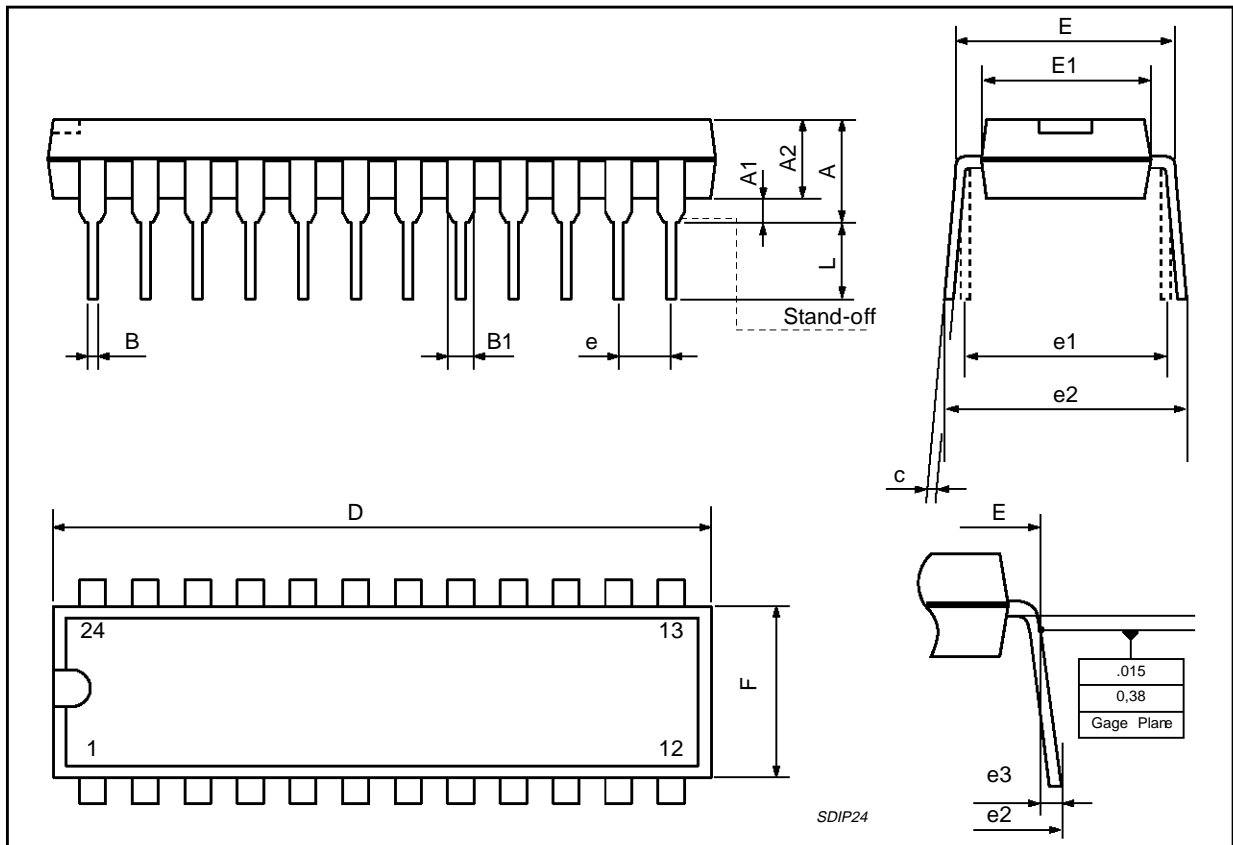

Information furnished is believed to be accurate and reliable. However, SGS-THOMSON Microelectronics assumes no responsibility for the consequences of use of such information nor for any infringement of patents or other rights of third parties which may result from its use. No license is granted by implication or otherwise under any patent or patent rights of SGS-THOMSON Microelectronics. Specifications mentioned in this publication are subject to change without notice. This publication supersedes and replaces all information previously supplied. SGS-THOMSON Microelectronics products are not authorized for use as critical components in life support devices or systems without express written approval of SGS-THOMSON Microelectronics.

© 1995 SGS-THOMSON Microelectronics - Printed in Italy - All Rights Reserved

SGS-THOMSON Microelectronics GROUP OF COMPANIES

Australia - Brazil - France - Germany - Hong Kong - Italy - Japan - Korea - Malaysia - Malta - Morocco - The Netherlands -
Singapore - Spain - Sweden - Switzerland - Taiwan - United Kingdom - U.S.A.