

SMBG AND SMBJ5.0 THRU 170CA

SURFACE MOUNT TRANSZORB™ TRANSIENT VOLTAGE SUPPRESSOR

Stand-off Voltage - 5.0 to 170 Volts Peak Pulse Power - 600 Watts

DO-214AA
MODIFIED J-BEND

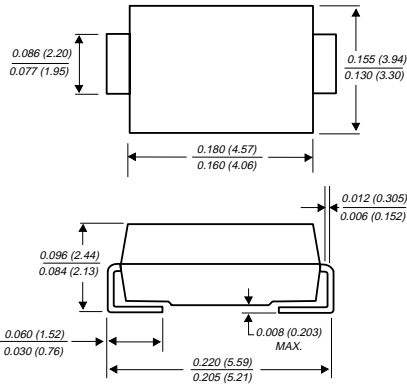

DO-215AA
GULL WING

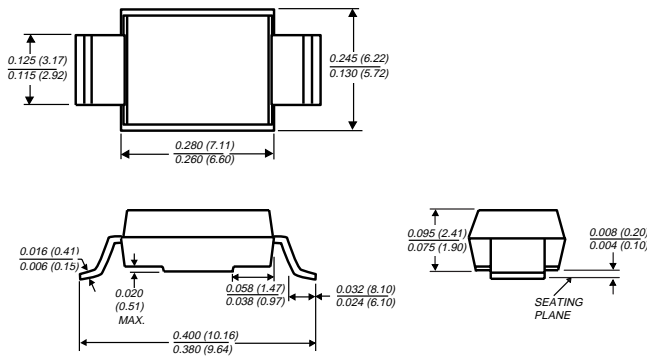

Dimensions in inches and (millimeters)

FEATURES

- ◆ Plastic package has Underwriters Laboratory Flammability Classification 94V-0
- ◆ For surface mounted applications in order to optimize board space
- ◆ Low profile package
- ◆ Built-in strain relief
- ◆ Glass passivated junction
- ◆ Low incremental surge resistance
- ◆ 600W peak pulse power capability with a 10/1000µs waveform, repetition rate (duty cycle): 0.01%
- ◆ Excellent clamping capability
- ◆ Fast response time: typically less than 1.0ps from 0 volts to $V_{(BR)}$ for unidirectional and 5.0ns for bidirectional types
- ◆ For devices with $V_{(BR)} \geq 10V$, I_D are typically less than 1.0µA
- ◆ High temperature soldering guaranteed: 250°C/10 seconds at terminals



MECHANICAL DATA

Case: JEDEC DO214AA / DO215AA molded plastic body over passivated junction

Terminals: Solder plated, solderable per MIL-STD-750, Method 2026

Polarity: For unidirectional types the color band denotes the cathode, which is positive with respect to the anode under normal TVS operation

Mounting Position: Any

Weight: 0.003 ounces, 0.093 gram

DEVICES FOR BIDIRECTIONAL APPLICATIONS

For bidirectional use suffix C or CA for types SMB-5.0 thru SMB-170 (eg. SMBG5.0C, SMBJ170CA).

Electrical characteristics apply in both directions

MAXIMUM RATINGS AND ELECTRICAL CHARACTERISTICS

Ratings at 25°C ambient temperature unless otherwise specified.

	SYMBOLS	VALUE	UNITS
Peak pulse power dissipation with a 10/1000µs waveform (NOTES 1, 2, FIG. 1)	PPPM	Minimum 600	Watts
Peak pulse current with a 10/1000µs waveform (NOTE 1)	IPPM	SEE TABLE 1	Amps
Peak forward surge current 8.3ms single half sine-wave superimposed on rated load (JEDEC Method) (NOTES 2, 3) - unidirectional only	IFSM	100.0	Amps
Maximum instantaneous forward voltage at 50A (NOTE 3) unidirectional only	V _F	3.5	Volts
Operating junction and storage temperature range	T _J , T _{STG}	-55 to +150	°C

NOTES:

- (1) Non-repetitive current pulse, per Fig.3 and derated above $T_A=25^\circ\text{C}$ per Fig. 2
- (2) Mounted on 0.2 x 0.2" (5.0 x 5.0mm) copper pads to each terminal
- (3) Measured on 8.3ms single half sine-wave. For uni-directional devices only.

ELECTRICAL CHARACTERISTICS (T_A=25°C unless otherwise noted) TABLE 1

Device Type Gull Wing Lead	Device Type Modified "J" Bend Lead	Device Marking Code		Breakdown Voltage V _(BR) (Volts) (NOTE 1) (MIN /MAX)	Test Current at I _T (mA)	Stand-off Voltage V _{WM} (Volts)	Maximum Reverse Leakage I _D at V _{WM} (µA) (NOTE 3)	Maximum Peak Pulse Surge Current I _{PPM} (NOTE 2) (Amps)	Maximum Clamping Voltage at I _{PPM} V _C (Volts)
		UNI	BI						
SMBG5.0	SMBJ5.0	KD	KD	6.40 / 7.82	10	5.0	800	62.5	9.6
SMBG5.0A	SMBJ5.0A	KE	KE	6.40 / 7.07	10	5.0	800	65.2	9.2
SMBG6.0	SMBJ6.0	KF	KF	6.67 / 8.15	10	6.0	800	52.6	11.4
SMBG6.0A	SMBJ6.0A	KG	KG	6.67 / 7.37	10	6.0	800	58.3	10.3
SMBG6.5	SMBJ6.5	KH	AH	7.22 / 8.82	10	6.5	500	48.8	12.3
SMBG6.5A	SMBJ6.5A	KK	AK	7.22 / 7.98	10	6.5	500	53.6	11.2
SMBG7.0	SMBJ7.0	KL	KL	7.78 / 9.51	10	7.0	200	45.1	13.3
SMBG7.0A	SMBJ7.0A	KM	KM	7.78 / 8.60	10	7.0	200	50.0	12.0
SMBG7.5	SMBJ7.5	KN	AN	8.33 / 10.2	1.0	7.5	100	42.0	14.3
SMBG7.5A	SMBJ7.5A	KP	AP	8.33 / 9.21	1.0	7.5	100	46.5	12.9
SMBG8.0	SMBJ8.0	KQ	AQ	8.89 / 10.9	1.0	8.0	50	40.0	15.0
SMBG8.0A	SMBJ8.0A	KR	AR	8.89 / 9.83	1.0	8.0	50	44.1	13.6
SMBG8.5	SMBJ8.5	KS	AS	9.44 / 11.5	1.0	8.5	20	37.7	15.9
SMBG8.5A	SMBJ8.5A	KT	AT	9.44 / 10.4	1.0	8.5	20	41.7	14.4
SMBG9.0	SMBJ9.0	KU	AU	10.0 / 12.2	1.0	9.0	10	35.5	16.9
SMBG9.0A	SMBJ9.0A	KV	AV	10.0 / 11.1	1.0	9.0	10	39.0	15.4
SMBG10	SMBJ10	KW	AW	11.1 / 13.6	1.0	10	5.0	31.9	18.8
SMBG10A	SMBJ10A	KX	AX	11.1 / 12.3	1.0	10	5.0	35.3	17.0
SMBG11	SMBJ11	KY	KY	12.2 / 14.9	1.0	11	5.0	29.9	20.1
SMBG11A	SMBJ11A	KZ	KZ	12.2 / 13.5	1.0	11	5.0	33.0	18.2
SMBG12	SMBJ12	LD	BD	13.3 / 16.3	1.0	12	5.0	27.3	22.0
SMBG12A	SMBJ12A	LE	BE	13.3 / 14.7	1.0	12	5.0	30.2	19.9
SMBG13	SMBJ13	LF	LF	14.4 / 17.6	1.0	13	5.0	25.2	23.8
SMBG13A	SMBJ13A	LG	LG	14.4 / 15.9	1.0	13	5.0	27.9	21.5
SMBG14	SMBJ14	LH	BH	15.6 / 19.1	1.0	14	5.0	23.3	25.8
SMBG14A	SMBJ14A	LK	BK	15.6 / 17.2	1.0	14	5.0	25.9	23.2
SMBG15	SMBJ15	LL	BL	16.7 / 20.4	1.0	15	5.0	22.3	26.9
SMBG15A	SMBJ15A	LM	BM	16.7 / 18.5	1.0	15	5.0	24.6	24.4
SMBG16	SMBJ16	LN	LN	17.8 / 21.8	1.0	16	5.0	20.8	28.8
SMBG16A	SMBJ16A	LP	LM	17.8 / 19.7	1.0	16	5.0	23.1	26.0
SMBG17	SMBJ17	LQ	LQ	18.9 / 23.1	1.0	17	5.0	19.7	30.5
SMBG17A	SMBJ17A	LR	LR	18.9 / 20.9	1.0	17	5.0	21.7	27.6
SMBG18	SMBJ18	LS	BS	20.0 / 24.4	1.0	18	5.0	18.6	32.2
SMBG18A	SMBJ18A	LT	BT	20.0 / 22.1	1.0	18	5.0	20.5	29.2
SMBG20	SMBJ20	LU	LU	22.2 / 27.1	1.0	20	5.0	16.8	35.8
SMBG20A	SMBJ20A	LV	LV	22.2 / 24.5	1.0	20	5.0	18.5	32.4
SMBG22	SMBJ22	LW	BW	24.4 / 29.8	1.0	22	5.0	15.2	39.4
SMBG22A	SMBJ22A	LX	BX	24.4 / 26.9	1.0	22	5.0	16.9	35.5
SMBG24	SMBJ24	LY	BY	26.7 / 32.6	1.0	24	5.0	14.0	43.0
SMBG24A	SMBJ24A	LZ	BZ	26.7 / 29.5	1.0	24	5.0	15.4	38.9
SMBG26	SMBJ26	MD	CD	28.9 / 35.3	1.0	26	5.0	12.9	46.6
SMBG26A	SMBJ26A	ME	CE	28.9 / 31.9	1.0	26	5.0	14.3	42.1
SMBG28	SMBJ28	MF	MF	31.1 / 38.0	1.0	28	5.0	12.0	50.0
SMBG28A	SMBJ28A	MG	MG	31.1 / 34.4	1.0	28	5.0	13.2	45.4
SMBG30	SMBJ30	MH	CH	33.3 / 40.7	1.0	30	5.0	11.2	53.5
SMBG30A	SMBJ30A	MK	CK	33.3 / 36.8	1.0	30	5.0	12.4	48.4
SMBG33	SMBJ33	ML	CL	36.7 / 44.9	1.0	33	5.0	10.2	59.0
SMBG33A	SMBJ33A	MM	CM	36.7 / 40.6	1.0	33	5.0	11.3	53.3
SMBG36	SMBJ36	MN	CN	40.0 / 48.9	1.0	36	5.0	9.3	64.3
SMBG36A	SMBJ36A	MP	CP	40.0 / 44.2	1.0	36	5.0	10.3	58.1
SMBG40	SMBJ40	MQ	CQ	44.4 / 54.3	1.0	40	5.0	8.4	71.4
SMBG40A	SMBJ40A	MR	CR	44.4 / 49.1	1.0	40	5.0	9.3	64.5
SMBG43	SMBJ43	MS	CS	47.8 / 58.4	1.0	43	5.0	7.8	76.7
SMBG43A	SMBJ43A	MT	CT	47.8 / 52.8	1.0	43	5.0	8.6	69.4
SMBG45	SMBJ45	MU	MU	50.0 / 61.1	1.0	45	5.0	7.5	80.3
SMBG45A	SMBJ45A	MV	MV	50.0 / 55.3	1.0	45	5.0	8.3	72.7
SMBG48	SMBJ48	MW	MW	53.3 / 65.1	1.0	48	5.0	7.0	85.5
SMBG48A	SMBJ48A	MX	MX	53.3 / 58.9	1.0	48	5.0	7.8	77.4
SMBG51	SMBJ51	MY	MY	56.7 / 69.3	1.0	51	5.0	6.6	91.1
SMBG51A	SMBJ51A	MZ	MZ	56.7 / 62.7	1.0	51	5.0	7.3	82.4

ELECTRICAL CHARACTERISTICS (T_A = 25°C unless otherwise noted) TABLE 1 (Cont'd)

Device Type Gull Wing Lead	Device Type Modified "J" Bend Lead	Device Marking Code		Breakdown Voltage V _(BR) (Volts) (NOTE 1) (Min / Max)	Test Current at I _T (mA)	Stand-off Voltage V _{WM} (Volts)	Maximum Reverse Leakage I _D at V _{WM} (μA)(NOTE 3)	Maximum Peak Pulse Surge Current I _{PPM} (NOTE 2) (Amps)	Maximum Clamping Voltage at I _{PPM} V _C (Volts)
		UNI	BI						
SMBG54	SMBJ54	ND	ND	60.0 / 73.3	1.0	54	5.0	6.2	96.3
SMBG54A	SMBJ54A	NE	NE	60.0 / 66.3	1.0	54	5.0	6.9	87.1
SMBG58	SMBJ58	NF	NF	64.4 / 78.7	1.0	58	5.0	5.8	103
SMBG58A	SMBJ58A	NG	NG	64.4 / 71.2	1.0	58	5.0	6.4	93.6
SMBG60	SMBJ60	NH	NH	66.7 / 81.5	1.0	60	5.0	5.6	107
SMBG60A	SMBJ60A	NK	NK	66.7 / 73.7	1.0	60	5.0	6.2	96.8
SMBG64	SMBJ64	NL	NL	71.1 / 86.9	1.0	64	5.0	5.3	114
SMBG64A	SMBJ64A	NM	NM	71.1 / 78.6	1.0	64	5.0	5.8	103
SMBG70	SMBJ70	NN	NN	77.8 / 95.1	1.0	70	5.0	4.8	125
SMBG70A	SMBJ70A	NP	NP	77.8 / 86.0	1.0	70	5.0	5.3	113
SMBG75	SMBJ75	NQ	NQ	83.3 / 102	1.0	75	5.0	4.5	134
SMBG75A	SMBJ75A	NR	NR	83.3 / 92.1	1.0	75	5.0	5.0	121
SMBG78	SMBJ78	NS	NS	86.7 / 106	1.0	78	5.0	4.3	139
SMBG78A	SMBJ78A	NT	NT	86.7 / 95.8	1.0	78	5.0	4.8	126
SMBG85	SMBJ85	NU	NU	94.4 / 115	1.0	85	5.0	4.0	151
SMBG85A	SMBJ85A	NV	NV	94.4 / 104	1.0	85	5.0	4.4	137
SMBG90	SMBJ90	NW	NW	100 / 122	1.0	90	5.0	3.8	160
SMBG90A	SMBJ90A	NX	NX	100 / 111	1.0	90	6.0	4.1	146
SMBG100	SMBJ100	NY	NY	111 / 136	1.0	100	5.0	3.4	179
SMBG100A	SMBJ100A	NZ	NZ	111 / 123	1.0	100	5.0	3.7	162
SMBG110	SMBJ110	PD	PD	122 / 149	1.0	110	5.0	3.1	196
SMBG110A	SMBJ110A	PE	PE	122 / 135	1.0	110	5.0	3.4	177
SMBG120	SMBJ120	PF	PF	133 / 163	1.0	120	5.0	2.8	214
SMBG120A	SMBJ120A	PG	PG	133 / 147	1.0	120	5.0	3.1	193
SMBG130	SMBJ130	PH	PH	144 / 176	1.0	130	5.0	2.6	231
SMBG130A	SMBJ130A	PK	PK	144 / 159	1.0	130	5.0	2.9	209
SMBG150	SMBJ150	PL	PL	167 / 204	1.0	150	5.0	2.2	268
SMBG150A	SMBJ150A	PM	PM	167 / 185	1.0	150	5.0	2.5	243
SMBG160	SMBJ160	PN	PN	178 / 218	1.0	160	5.0	2.1	287
SMBG160A	SMBJ160A	PP	PP	178 / 197	1.0	160	5.0	2.3	259
SMBG170	SMBJ170	PQ	PQ	189 / 231	1.0	170	5.0	2.0	304
SMBG170A	SMBJ170A	PR	PR	189 / 209	1.0	170	5.0	2.2	275

NOTES:

- (1) V_(BR) measured after I_T applied for 300μs square wave pulse or equivalent
- (2) Surge current waveform per Fig. 3 and derate per Fig. 2
- (3) For bi-directional types having V_{WM} of 10 Volts and less, the I_D limit is doubled
- (4) For the bi-directional SMBG/SMBJ5.0CA, the maximum V_(BR) is 7.25 Volts
- (5) All terms and symbols are consistent with ANSI/IEEE C62.35

APPLICATION NOTES

These surface mountable packages are designed specifically for transient voltage suppression. The wide leads assure a large surface contact for good heat dissipation, and a low resistance path for surge current flow to ground. These high speed transient voltage suppressors can be used to effectively protect sensitive components such as integrated circuits and MOS devices.

A 600W (SMB) device is normally selected when the threat of transients is from lightning-induced transients conducted via external leads or I/O lines. It is also used to protect against switching transients induced by large coils or industrial motors. System impedance at component level in a system is usually high enough to limit the current to within the peak pulse current (I_{PP}) rating of this series.

RECOMMENDED PAD SIZES

The pad dimensions should be 0.010" (0.25mm) longer than the contact size, in the lead axis.
This allows a solder fillet to form, see Fig. below. Contact factory for soldering methods.

GULL-WING

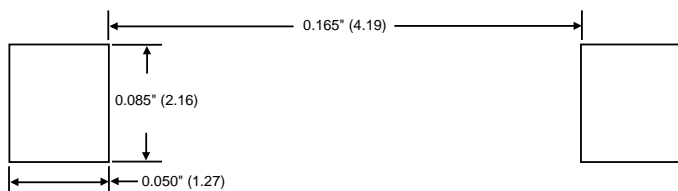

MODIFIED J-BEND

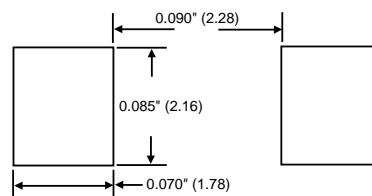

MAXIMUM RATINGS AND CHARACTERISTIC CURVES SMBG AND SMBJ5.0 THRU 170CA

FIG. 1 - PEAK PULSE POWER RATING CURVE

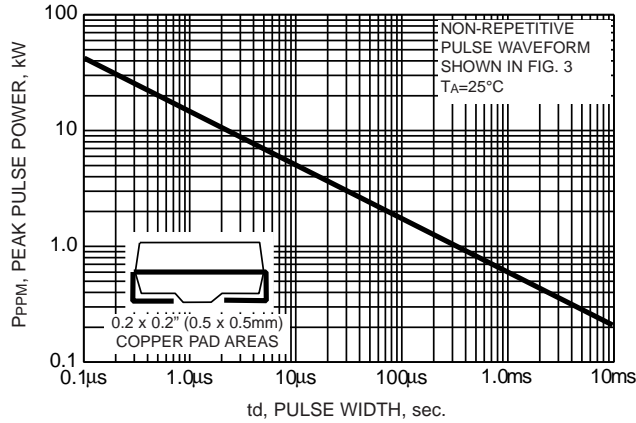

FIG. 2 - PULSE DERATING CURVE

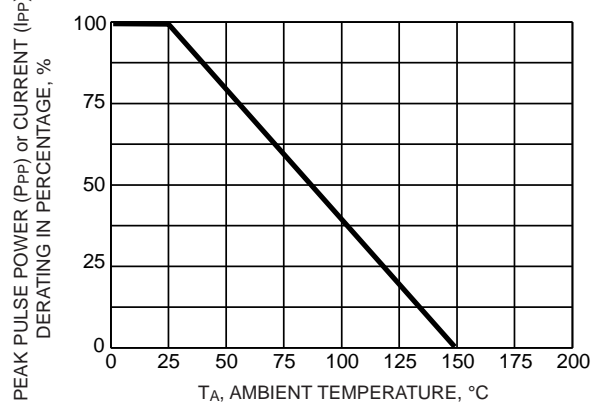

FIG. 3 - PULSE WAVEFORM

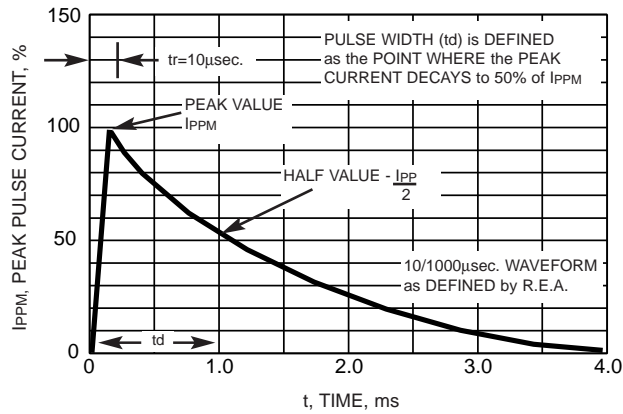

FIG. 4 - TYPICAL JUNCTION CAPACITANCE UNIDIRECTIONAL

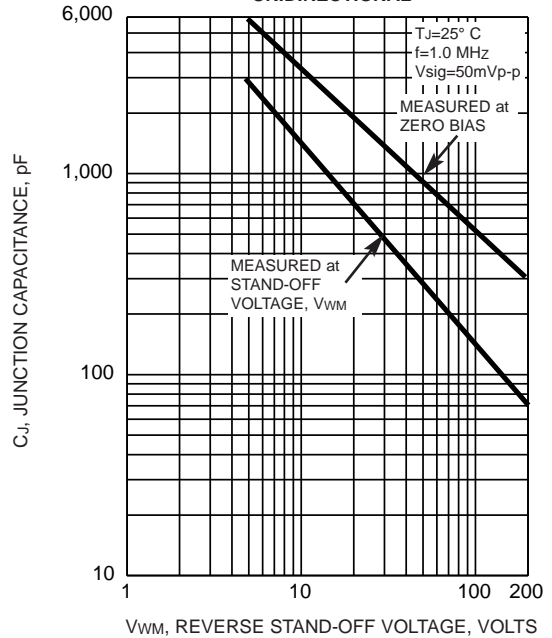

FIG. 5 - TYPICAL JUNCTION CAPACITANCE BIDIRECTIONAL

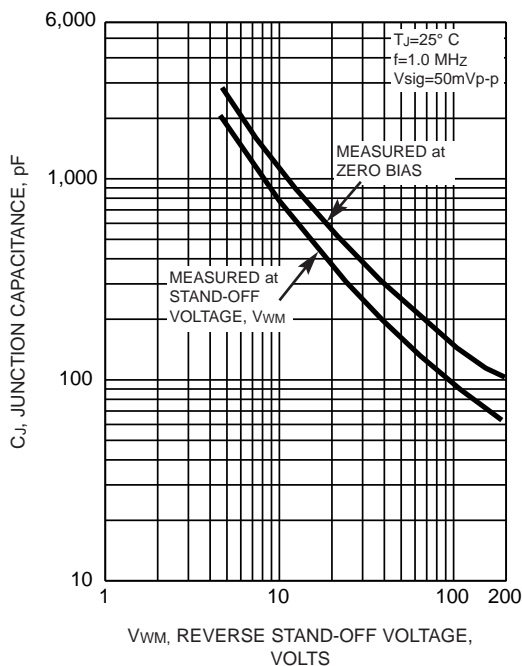

FIG. 6 - MAXIMUM NON-REPETITIVE PEAK FORWARD SURGE CURRENT

