

Power MOSFET

PRODUCT SUMMARY		
V_{DS} (V)	- 60	
$R_{DS(on)}$ (Ω)	$V_{GS} = - 10$ V	0.14
Q_g (Max.) (nC)	34	
Q_{gs} (nC)	9.9	
Q_{gd} (nC)	16	
Configuration	Single	

FEATURES

- Advanced Process Technology
- Surface Mount (IRF9Z34S/SiHF9Z34S)
- Low-Profile Through-Hole (IRSiHF9Z34L/SiHF9Z34L)
- 175 °C Operating Temperature
- Fast Switching
- P-Channel
- Fully Avalanche Rated
- Lead (Pb)-free Available



Available

RoHS*
COMPLIANT

I²PAK (TO-262)

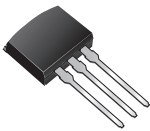

D²PAK (TO-263)

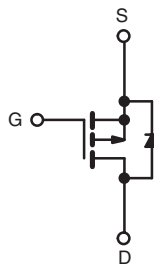
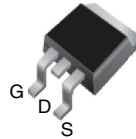

P-Channel MOSFET

DESCRIPTION

Third generation Power MOSFETs from Vishay utilize advanced processing techniques to achieve extremely low on-resistance per silicon area. This benefit, combined with the fast switching speed and ruggedized device design that Power MOSFETs are well known for, provides the designer with an extremely efficient and reliable device for use in a wide variety of applications.

The D²PAK is a surface mount power package capable of accommodating die sizes up to HEX-4. It provides the highest power capability and the lowest possible on-resistance in any existing surface mount package. The D²PAK is suitable for high current applications because of its low internal connection resistance and can dissipate up to 2.0 W in a typical surface mount application.

The through-hole version (IRSiHF9Z34L/SiHF9Z34L) is available for low-profile applications.

ORDERING INFORMATION

Package	D ² PAK (TO-263)	D ² PAK (TO-263)	D ² PAK (TO-263)	I ² PAK (TO-262)
Lead (Pb)-free	IRF9Z34SPbF	IRF9Z34STRLPbF ^a	IRF9Z34STRRPbF ^a	IRF9Z34LPbF
	SiHF9Z34S-E3	SiHF9Z34STL-E3 ^a	SiHF9Z34STR-E3 ^a	SiHF9Z34L-E3
SnPb	IRF9Z34S	IRF9Z34STRL ^a	IRF9Z34STRR ^a	IRF9Z34L
	SiHF9Z34S	SiHF9Z34STL ^a	SiHF9Z34STR ^a	SiHF9Z34L

Note

a. See device orientation.

ABSOLUTE MAXIMUM RATINGS $T_C = 25$ °C, unless otherwise noted

PARAMETER	SYMBOL	LIMIT	UNIT	
Drain-Source Voltage	V_{DS}	- 60	V	
Gate-Source Voltage	V_{GS}	± 20		
Continuous Drain Current	V_{GS} at - 10 V	$T_C = 25$ °C	- 18	A
		$T_C = 100$ °C	- 13	
Pulsed Drain Current ^{a, e}	I_{DM}	- 72		
Linear Derating Factor		0.59	W/°C	
Single Pulse Avalanche Energy ^{b, e}	E_{AS}	370	mJ	
Avalanche Current ^a	I_{AR}	- 18	A	
Repetitive Avalanche Energy ^a	E_{AR}	8.8	mJ	

* Pb containing terminations are not RoHS compliant, exemptions may apply



ABSOLUTE MAXIMUM RATINGS $T_C = 25\text{ }^\circ\text{C}$, unless otherwise noted				
PARAMETER		SYMBOL	LIMIT	UNIT
Maximum Power Dissipation	$T_C = 25\text{ }^\circ\text{C}$	P_D	3.7	W
	$T_A = 25\text{ }^\circ\text{C}$		88	
Peak Diode Recovery $dV/dt^c, e$		dV/dt	- 4.5	V/ns
Operating Junction and Storage Temperature Range		T_J, T_{stg}	- 55 to + 175	$^\circ\text{C}$
Soldering Recommendations (Peak Temperature)	for 10 s		300 ^d	

Notes

- a. Repetitive rating; pulse width limited by maximum junction temperature (see fig. 11).
- b. $V_{DD} = - 25\text{ V}$, starting $T_J = 25\text{ }^\circ\text{C}$, $L = 1.3\text{ mH}$, $R_G = 25\text{ }^\circ\Omega$, $I_{AS} = - 18\text{ A}$ (see fig. 12).
- c. $I_{SD} \leq - 18\text{ A}$, $dI/dt \leq 170\text{ A}/\mu\text{s}$, $V_{DD} \leq V_{DS}$, $T_J \leq 175\text{ }^\circ\text{C}$.
- d. 1.6 mm from case.
- e. Uses IRF9Z34/SiHF9Z34 data and test conditions.

THERMAL RESISTANCE RATINGS				
PARAMETER	SYMBOL	TYP.	MAX.	UNIT
Maximum Junction-to-Ambient (PCB Mounted, steady-state) ^a	R_{thJA}	-	40	$^\circ\text{C}/\text{W}$
Maximum Junction-to-Case (Drain)	R_{thJC}	-	1.7	

Note

- a. When mounted on 1" square PCB (FR-4 or G-10 material).

SPECIFICATIONS $T_J = 25\text{ }^\circ\text{C}$, unless otherwise noted						
PARAMETER	SYMBOL	TEST CONDITIONS	MIN.	TYP.	MAX.	UNIT
Static						
Drain-Source Breakdown Voltage	V_{DS}	$V_{GS} = 0\text{ V}$, $I_D = - 250\text{ }^\circ\mu\text{A}$	- 60	-	-	V
V_{DS} Temperature Coefficient	$\Delta V_{DS}/T_J$	Reference to $25\text{ }^\circ\text{C}$, $I_D = - 1\text{ mA}^c$	-	- 0.06	-	$\text{V}/^\circ\text{C}$
Gate-Source Threshold Voltage	$V_{GS(th)}$	$V_{DS} = V_{GS}$, $I_D = - 250\text{ }^\circ\mu\text{A}$	- 2.0	-	- 4.0	V
Gate-Source Leakage	I_{GSS}	$V_{GS} = \pm 20\text{ V}$	-	-	± 100	nA
Zero Gate Voltage Drain Current	I_{DSS}	$V_{DS} = - 60\text{ V}$, $V_{GS} = 0\text{ V}$	-	-	- 100	μA
		$V_{DS} = - 48\text{ V}$, $V_{GS} = 0\text{ V}$, $T_J = 150\text{ }^\circ\text{C}$	-	-	- 500	
Drain-Source On-State Resistance	$R_{DS(on)}$	$V_{GS} = - 10\text{ V}$, $I_D = - 11\text{ A}^b$	-	-	0.14	Ω
Forward Transconductance	g_{fs}	$V_{DS} = - 25\text{ V}$, $I_D = - 11\text{ A}^c$	5.9	-	-	S
Dynamic						
Input Capacitance	C_{iss}	$V_{GS} = 0\text{ V}$, $V_{DS} = - 25\text{ V}$, $f = 1.0\text{ MHz}$, see fig. 5 ^c	-	1100	-	pF
Output Capacitance	C_{oss}		-	620	-	
Reverse Transfer Capacitance	C_{rss}		-	100	-	
Total Gate Charge	Q_g	$V_{GS} = - 10\text{ V}$, $I_D = - 18\text{ A}$, $V_{DS} = - 48\text{ V}$, see fig. 6 and 13 ^{b, c}	-	-	34	nC
Gate-Source Charge	Q_{gs}		-	-	9.9	
Gate-Drain Charge	Q_{gd}		-	-	16	
Turn-On Delay Time	$t_{d(on)}$	$V_{DD} = - 30\text{ V}$, $I_D = - 18\text{ A}$, $R_G = 12\text{ }^\circ\Omega$, $R_D = 1.5\text{ }^\circ\Omega$, see fig. 10 ^{b, c}	-	18	-	ns
Rise Time	t_r		-	120	-	
Turn-Off Delay Time	$t_{d(off)}$		-	20	-	
Fall Time	t_f		-	58	-	



SPECIFICATIONS $T_J = 25\text{ }^\circ\text{C}$, unless otherwise noted						
PARAMETER	SYMBOL	TEST CONDITIONS	MIN.	TYP.	MAX.	UNIT
Drain-Source Body Diode Characteristics						
Continuous Source-Drain Diode Current	I_S	MOSFET symbol showing the integral reverse p - n junction diode 	-	-	- 18	A
Pulsed Diode Forward Current ^a	I_{SM}		-	-	- 72	
Body Diode Voltage	V_{SD}	$T_J = 25\text{ }^\circ\text{C}$, $I_S = -18\text{ A}$, $V_{GS} = 0\text{ V}$ ^b	-	-	- 6.3	V
Body Diode Reverse Recovery Time	t_{rr}	$T_J = 25\text{ }^\circ\text{C}$, $I_F = -18\text{ A}$, $di/dt = 100\text{ A}/\mu\text{s}$ ^{b, c}	-	100	200	ns
Body Diode Reverse Recovery Charge	Q_{rr}		-	280	520	nC
Forward Turn-On Time	t_{on}	Intrinsic turn-on time is negligible (turn-on is dominated by L_S and L_D)				

Notes

- a. Repetitive rating; pulse width limited by maximum junction temperature (see fig. 11).
- b. Pulse width $\leq 300\text{ }\mu\text{s}$; duty cycle $\leq 2\%$.
- c. Uses IRF9Z34/SiHF9Z34 data and test conditions.

TYPICAL CHARACTERISTICS $25\text{ }^\circ\text{C}$, unless otherwise noted

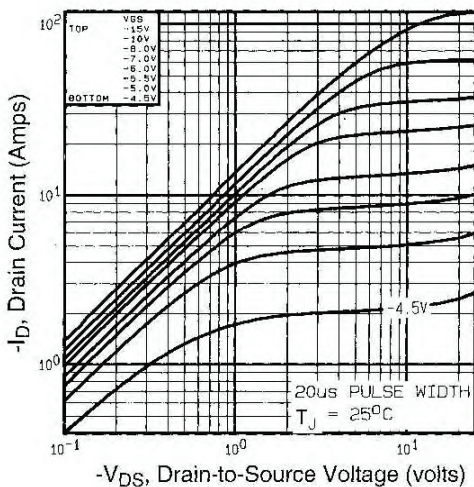

Fig. 1 - Typical Output Characteristics

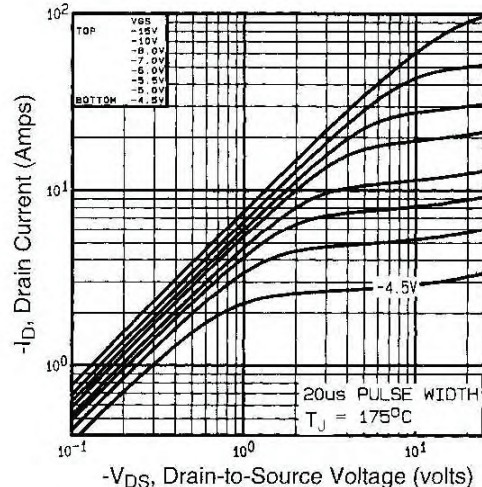

Fig. 2 - Typical Output Characteristics

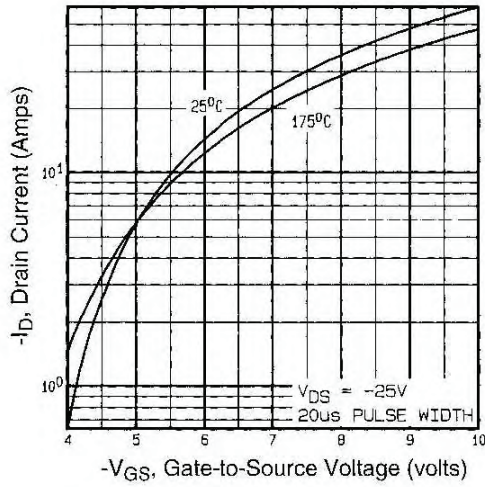

Fig. 3 - Typical Transfer Characteristics

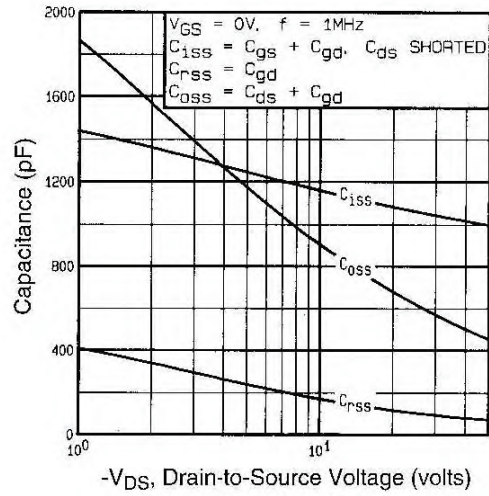

Fig. 5 - Typical Capacitance vs. Drain-to-Source Voltage

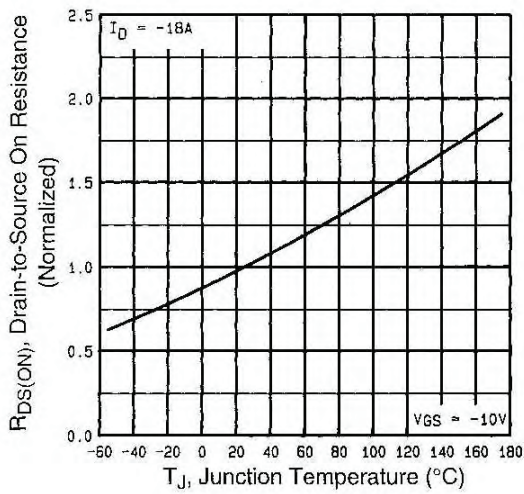

Fig. 4 - Normalized On-Resistance vs. Temperature

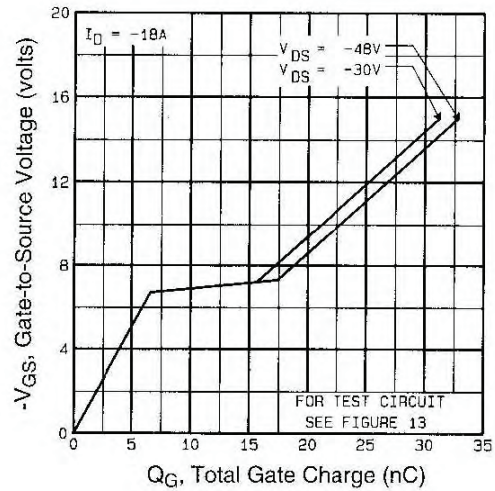

Fig. 6 - Typical Gate Charge vs. Gate-to-Source Voltage

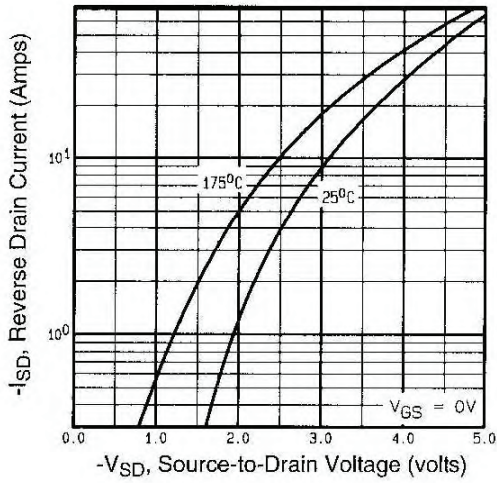

Fig. 7 - Typical Source-Drain Diode Forward Voltage

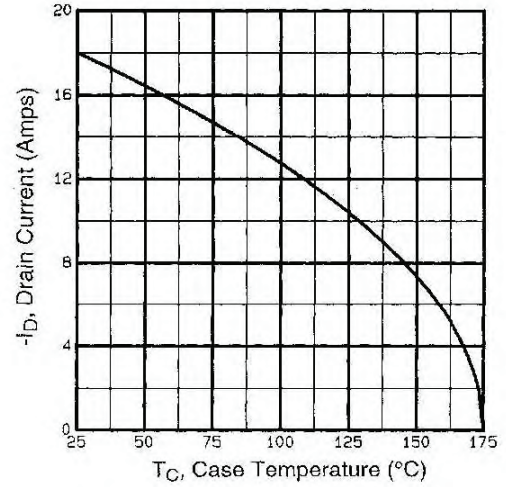

Fig. 9 - Maximum Drain Current vs. Case Temperature

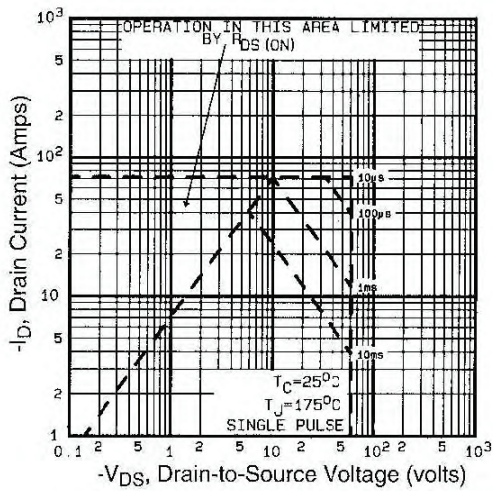

Fig. 8 - Maximum Safe Operating Area

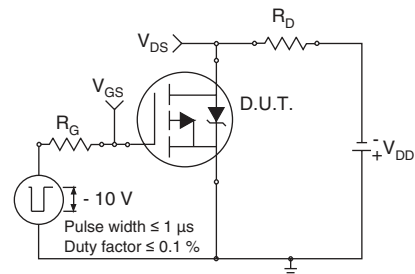

Fig. 10a - Switching Time Test Circuit

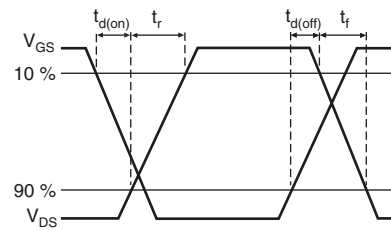

Fig. 10b - Switching Time Waveforms

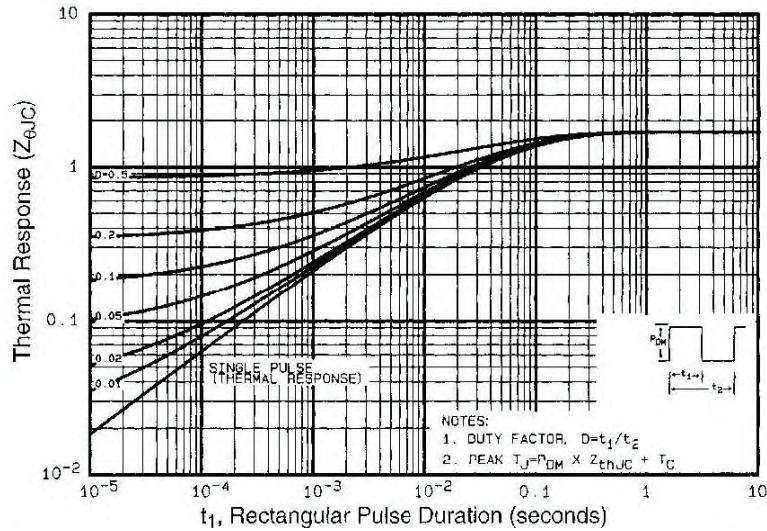

Fig. 11 - Maximum Effective Transient Thermal Impedance, Junction-to-Case

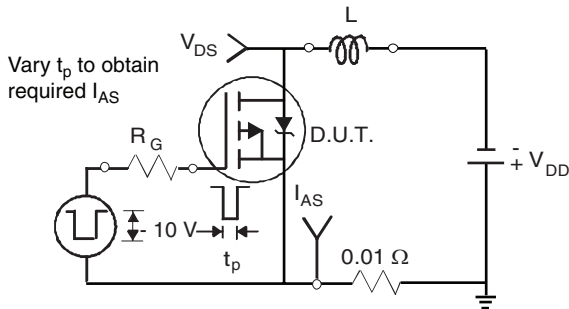

Fig. 12a - Unclamped Inductive Test Circuit

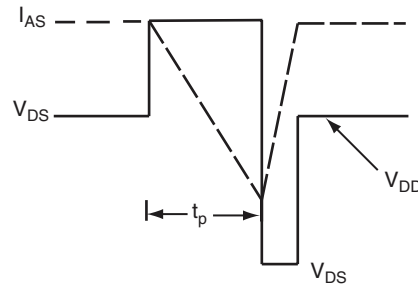

Fig. 12b - Unclamped Inductive Waveforms

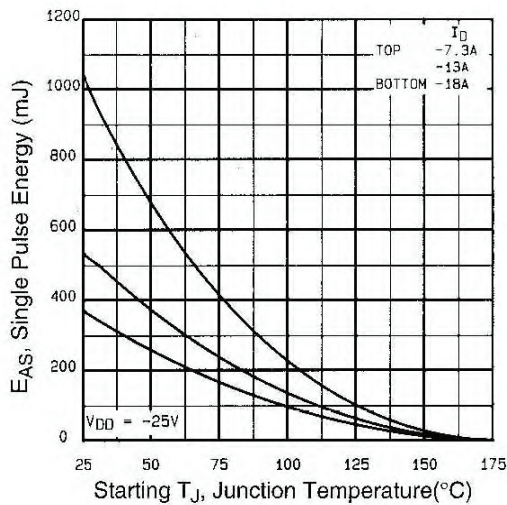

Fig. 12c - Maximum Avalanche Energy vs. Drain Current

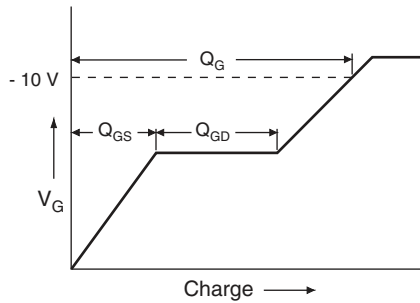

Fig. 13a - Maximum Avalanche Energy vs. Drain Current

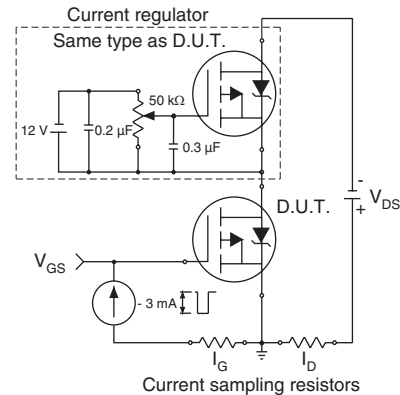
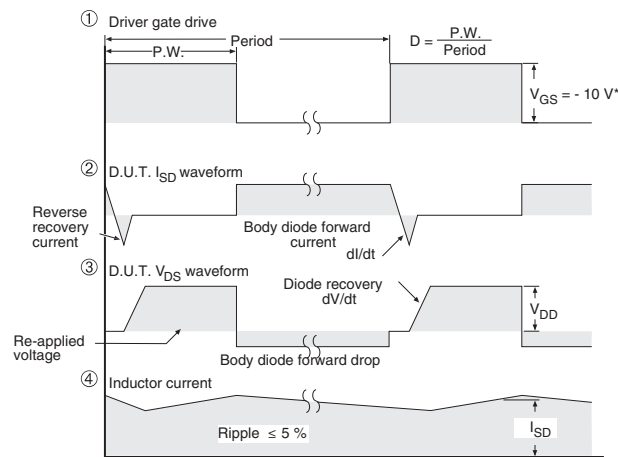
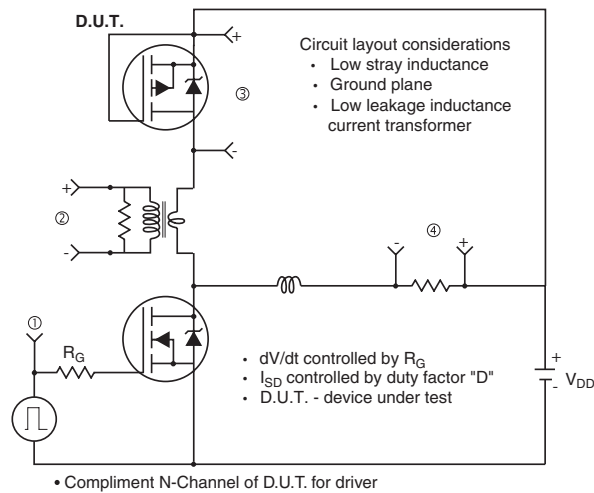

Fig. 13b - Gate Charge Test Circuit

Peak Diode Recovery dV/dt Test Circuit



* $V_{GS} = -5 V$ for logic level and $-3 V$ drive devices

Fig. 14 - For P-Channel

Vishay Siliconix maintains worldwide manufacturing capability. Products may be manufactured at one of several qualified locations. Reliability data for Silicon Technology and Package Reliability represent a composite of all qualified locations. For related documents such as package/tape drawings, part marking, and reliability data, see <http://www.vishay.com/ppg?91093>.



Disclaimer

All product specifications and data are subject to change without notice.

Vishay Intertechnology, Inc., its affiliates, agents, and employees, and all persons acting on its or their behalf (collectively, "Vishay"), disclaim any and all liability for any errors, inaccuracies or incompleteness contained herein or in any other disclosure relating to any product.

Vishay disclaims any and all liability arising out of the use or application of any product described herein or of any information provided herein to the maximum extent permitted by law. The product specifications do not expand or otherwise modify Vishay's terms and conditions of purchase, including but not limited to the warranty expressed therein, which apply to these products.

No license, express or implied, by estoppel or otherwise, to any intellectual property rights is granted by this document or by any conduct of Vishay.

The products shown herein are not designed for use in medical, life-saving, or life-sustaining applications unless otherwise expressly indicated. Customers using or selling Vishay products not expressly indicated for use in such applications do so entirely at their own risk and agree to fully indemnify Vishay for any damages arising or resulting from such use or sale. Please contact authorized Vishay personnel to obtain written terms and conditions regarding products designed for such applications.

Product names and markings noted herein may be trademarks of their respective owners.