

# Single Phase Rectifier Bridge

Standard and Avalanche Types

$I_{dAV} = 18 \text{ A}$   
 $V_{RRM} = 800-1600 \text{ V}$

$V_{RSM}$ V	$V_{BRmin}$ ① V	$V_{RRM}$ V	Standard Types	Avalanche Types
900		800	VBO 13-08NO2	
1300	1230	1200	VBO 13-12NO2	VBO 13-12AO2
1500	1430	1400	VBO 13-14NO2	VBO 13-14AO2
1700	1630	1600	VBO 13-16NO2	VBO 13-16AO2

① For Avalanche Types only

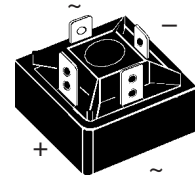
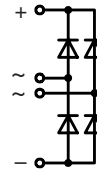

Symbol	Conditions	Maximum Ratings	Features	
$I_{dAV}$ ②	$T_C = 85^\circ\text{C}$ , module	18 A	<ul style="list-style-type: none"> <li>Avalanche rated parts available</li> <li>Package with DCB ceramic base plate</li> <li>Isolation voltage 3600 V~</li> <li>Planar passivated chips</li> <li>Low forward voltage drop</li> <li>1/4" fast-on terminals</li> <li>UL registered E 72873</li> </ul>	
$I_{dAVM}$	module	30 A		
$P_{RSM}$	$T_{VJ} = T_{VJM}$ t = 10 $\mu\text{s}$	2.5 kW		
$I_{FSM}$	$T_{VJ} = 45^\circ\text{C}$ ; $V_R = 0$	t = 10 ms (50 Hz), sine		220 A
		t = 8.3 ms (60 Hz), sine		230 A
$I^2t$	$T_{VJ} = 45^\circ\text{C}$ ; $V_R = 0$	t = 10 ms (50 Hz), sine		180 A
		t = 8.3 ms (60 Hz), sine		190 A
$T_{VJ}$	$T_{VJ} = T_{VJM}$ ; $V_R = 0$	t = 10 ms (50 Hz), sine		240 A <sup>2</sup> s
		t = 8.3 ms (60 Hz), sine		220 A <sup>2</sup> s
$T_{VJM}$	$T_{VJ} = T_{VJM}$	160 A <sup>2</sup> s		
$T_{stg}$	$V_R = 0$	150 A <sup>2</sup> s		
$V_{ISOL}$	50/60 Hz, RMS $I_{ISOL} \leq 1 \text{ mA}$	t = 1 min	3000 V~	
		t = 1 s	3600 V~	
$M_d$	Mounting torque (M5) (10-32 UNF)	1.5-2 Nm		
		13-18 lb.in.		
Weight	typ.	15 g		

## Features

- Avalanche rated parts available
- Package with DCB ceramic base plate
- Isolation voltage 3600 V~
- Planar passivated chips
- Low forward voltage drop
- 1/4" fast-on terminals
- UL registered E 72873

## Applications

- Supplies for DC power equipment
- Input rectifiers for PWM inverter
- Battery DC power supplies
- Field supply for DC motors

## Advantages

- Easy to mount with one screw
- Space and weight savings
- Improved temperature and power cycling

## Dimensions in mm (1 mm = 0.0394")

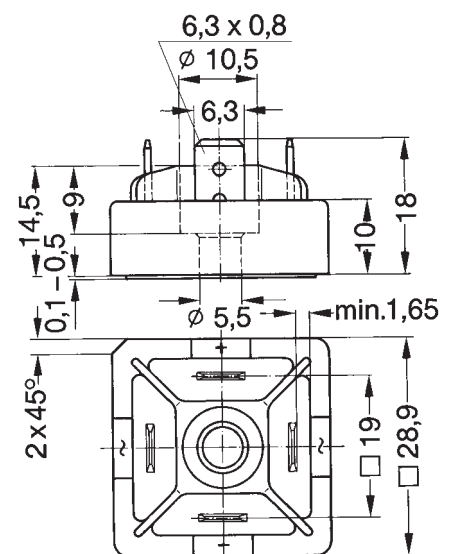

Symbol	Test Conditions	Characteristic Values
$I_R$	$V_R = V_{RRM}$ ; $T_{VJ} = 25^\circ\text{C}$	$\leq 0.3 \text{ mA}$
	$V_R = V_{RRM}$ ; $T_{VJ} = T_{VJM}$	$\leq 5 \text{ mA}$
$V_F$	$I_F = 55 \text{ A}$ ; $T_{VJ} = 25^\circ\text{C}$	$\leq 1.8 \text{ V}$
$V_{T0}$	For power-loss calculations only	0.85 V
$r_T$	$T_{VJ} = T_{VJM}$	17 m $\Omega$
$R_{thJC}$	per diode; DC current	5.6 K/W
	per module	1.4 K/W
$R_{thJK}$	per diode; DC current	6.0 K/W
	per module	1.5 K/W
$d_s$	Creeping distance on surface	13 mm
$d_A$	Creepage distance in air ③	9.5 mm
$a$	Max. allowable acceleration	50 m/s <sup>2</sup>

Data according to IEC 60747 and refer to a single diode unless otherwise stated

② for resistive load at bridge output, ③ with isolated fast-on tabs.

IXYS reserves the right to change limits, test conditions and dimensions.

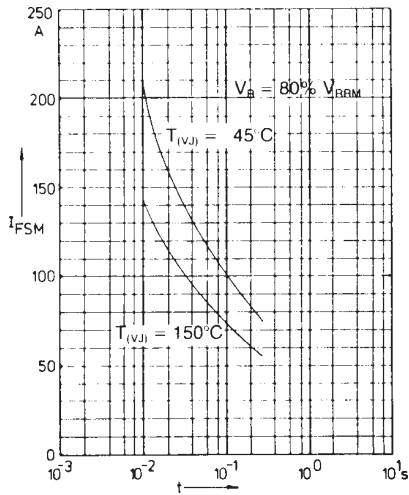

Fig. 1 Surge overload current per diode  
 $I_{FSM}$ : Crest value,  $t$ : duration

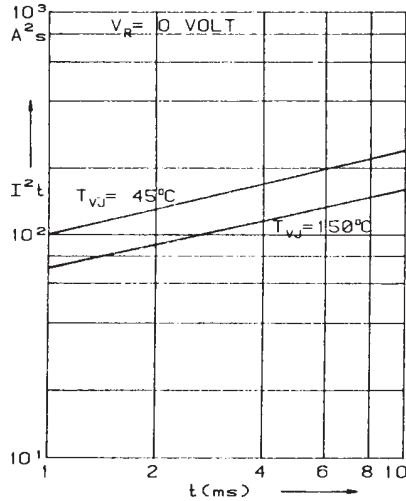

Fig. 2  $I^2t$  versus time (1-10 ms) per diode

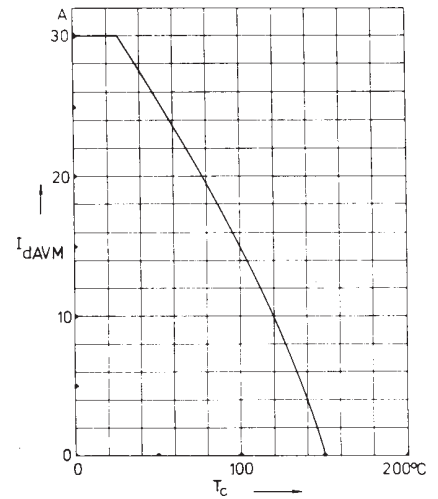

Fig. 3 Max. forward current at case temperature

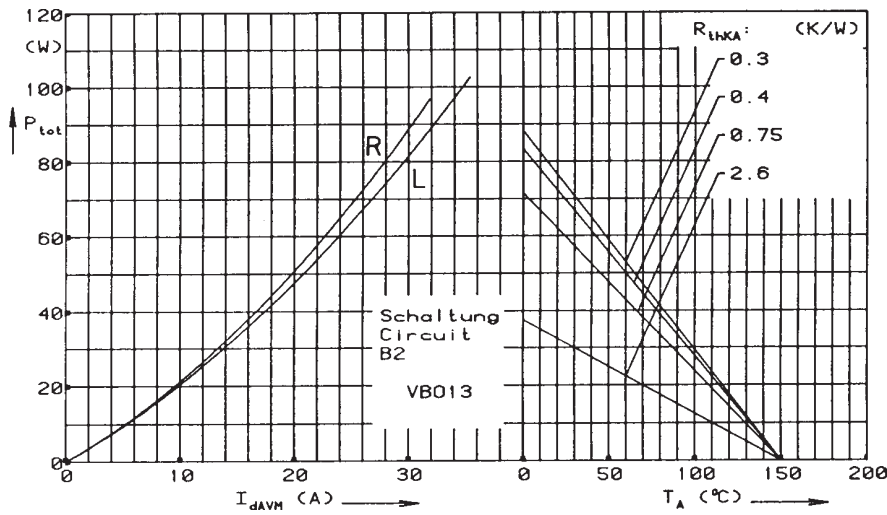

Fig. 4 Power dissipation versus direct output current and ambient temperature

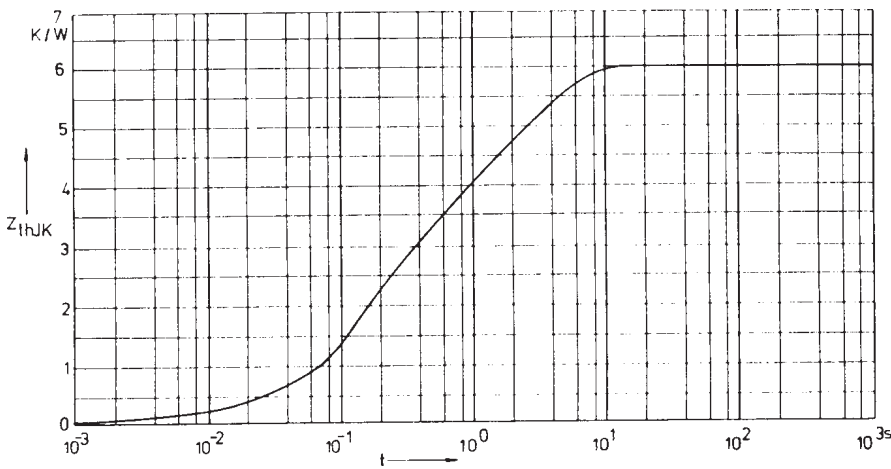

Fig. 5 Transient thermal impedance junction to heatsink per diode

Constants for  $Z_{thJK}$  calculation:

$i$	$R_{thi}$ (K/W)	$t_i$ (s)
1	0.059	0.00217
2	2.714	0.159
3	3.227	2.34