

DATA SHEET

BFQ67W

NPN 8 GHz wideband transistor

Product specification
File under Discrete Semiconductors, SC14

September 1995

NPN 8 GHz wideband transistor

BFQ67W

FEATURES

- High power gain
- Low noise figure
- High transition frequency
- Gold metallization ensures excellent reliability
- SOT323 envelope.

PINNING

PIN	DESCRIPTION
Code: V2	
1	base
2	emitter
3	collector

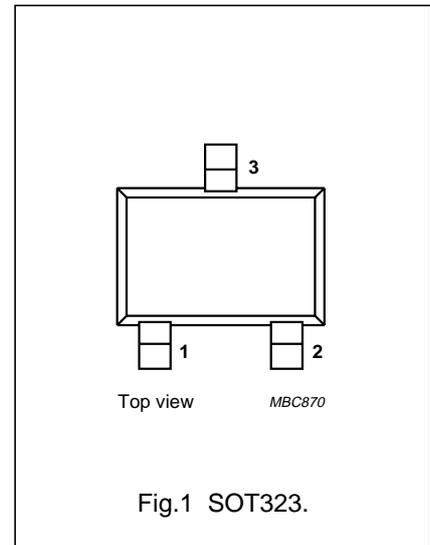

DESCRIPTION

NPN transistor in a plastic SOT323 envelope.

It is designed for wideband applications such as satellite TV tuners and RF portable communications equipment up to 2 GHz.

QUICK REFERENCE DATA

SYMBOL	PARAMETER	CONDITIONS	MIN.	TYP.	MAX.	UNIT
V_{CBO}	collector-base voltage	open emitter	–	–	20	V
V_{CEO}	collector-emitter voltage	open base	–	–	10	V
I_C	DC collector current		–	–	50	mA
P_{tot}	total power dissipation	up to $T_s = 118\text{ °C}$; note 1	–	–	300	mW
h_{FE}	DC current gain	$I_C = 15\text{ mA}$; $V_{CE} = 5\text{ V}$; $T_j = 25\text{ °C}$	60	100	–	
f_T	transition frequency	$I_C = 15\text{ mA}$; $V_{CE} = 8\text{ V}$; $f = 2\text{ GHz}$; $T_{amb} = 25\text{ °C}$	–	8	–	GHz
G_{UM}	maximum unilateral power gain	$I_C = 15\text{ mA}$; $V_{CE} = 8\text{ V}$; $f = 1\text{ GHz}$; $T_{amb} = 25\text{ °C}$	–	13	–	dB
F	noise figure	$I_C = 5\text{ mA}$; $V_{CE} = 8\text{ V}$; $f = 1\text{ GHz}$	–	1.3	–	dB

LIMITING VALUES

In accordance with the Absolute Maximum System (IEC 134).

SYMBOL	PARAMETER	CONDITIONS	MIN.	MAX.	UNIT
V_{CBO}	collector-base voltage	open emitter	–	20	V
V_{CEO}	collector-emitter voltage	open base	–	10	V
V_{EBO}	emitter-base voltage	open collector	–	2.5	V
I_C	DC collector current		–	50	mA
P_{tot}	total power dissipation	up to $T_s = 118\text{ °C}$; note 1	–	300	mW
T_{stg}	storage temperature		–65	150	°C
T_j	junction temperature		–	175	°C

Note

1. T_s is the temperature at the soldering point of the collector tab.

NPN 8 GHz wideband transistor

BFQ67W

THERMAL RESISTANCE

SYMBOL	PARAMETER	CONDITIONS	THERMAL RESISTANCE
$R_{th\ j-s}$	thermal resistance from junction to soldering point	up to $T_s = 118\text{ °C}$; note 1	190 K/W

Note

- T_s is the temperature at the soldering point of the collector tab.

CHARACTERISTICS

$T_j = 25\text{ °C}$, unless otherwise specified.

SYMBOL	PARAMETER	CONDITIONS	MIN.	TYP.	MAX.	UNIT
I_{CBO}	collector cut-off current	$I_E = 0$; $V_{CB} = 5\text{ V}$	–	–	50	nA
h_{FE}	DC current gain	$I_C = 15\text{ mA}$; $V_{CE} = 5\text{ V}$	60	100	–	
C_c	collector capacitance	$I_E = i_e = 0$; $V_{CB} = 8\text{ V}$; $f = 1\text{ MHz}$	–	0.7	–	pF
C_e	emitter capacitance	$I_C = i_c = 0$; $V_{EB} = 0.5\text{ V}$; $f = 1\text{ MHz}$	–	1.3	–	pF
C_{re}	feedback capacitance	$I_C = 0$; $V_{CB} = 8\text{ V}$; $f = 1\text{ MHz}$	–	0.5	–	pF
f_T	transition frequency	$I_C = 15\text{ mA}$; $V_{CE} = 8\text{ V}$; $f = 2\text{ GHz}$; $T_{amb} = 25\text{ °C}$	–	8	–	GHz
G_{UM}	maximum unilateral power gain (note 1)	$I_C = 15\text{ mA}$; $V_{CE} = 8\text{ V}$; $f = 1\text{ GHz}$; $T_{amb} = 25\text{ °C}$	–	13	–	dB
		$I_C = 15\text{ mA}$; $V_{CE} = 8\text{ V}$; $f = 2\text{ GHz}$; $T_{amb} = 25\text{ °C}$	–	8	–	dB
F	noise figure	$\Gamma_s = \Gamma_{opt}$; $I_C = 5\text{ mA}$; $V_{CE} = 8\text{ V}$; $f = 1\text{ GHz}$	–	1.3	–	dB
		$\Gamma_s = \Gamma_{opt}$; $I_C = 15\text{ mA}$; $V_{CE} = 8\text{ V}$; $f = 1\text{ GHz}$	–	2	–	dB
		$\Gamma_s = \Gamma_{opt}$; $I_C = 5\text{ mA}$; $V_{CE} = 8\text{ V}$; $f = 2\text{ GHz}$	–	2.2	–	dB
		$I_C = 5\text{ mA}$; $V_{CE} = 8\text{ V}$; $f = 2\text{ GHz}$; $Z_s = 60\ \Omega$	–	2.5	–	dB
		$\Gamma_s = \Gamma_{opt}$; $I_C = 15\text{ mA}$; $V_{CE} = 8\text{ V}$; $f = 2\text{ GHz}$	–	2.7	–	dB
		$I_C = 5\text{ mA}$; $V_{CE} = 8\text{ V}$; $f = 2\text{ GHz}$; $Z_s = 60\ \Omega$	–	3	–	dB

Note

- G_{UM} is the maximum unilateral power gain, assuming S_{12} is zero and

$$G_{UM} = 10 \log \left(\frac{|S_{21}|^2}{(1 - |S_{11}|^2)(1 - |S_{22}|^2)} \right) \text{ dB.}$$

NPN 8 GHz wideband transistor

BFQ67W

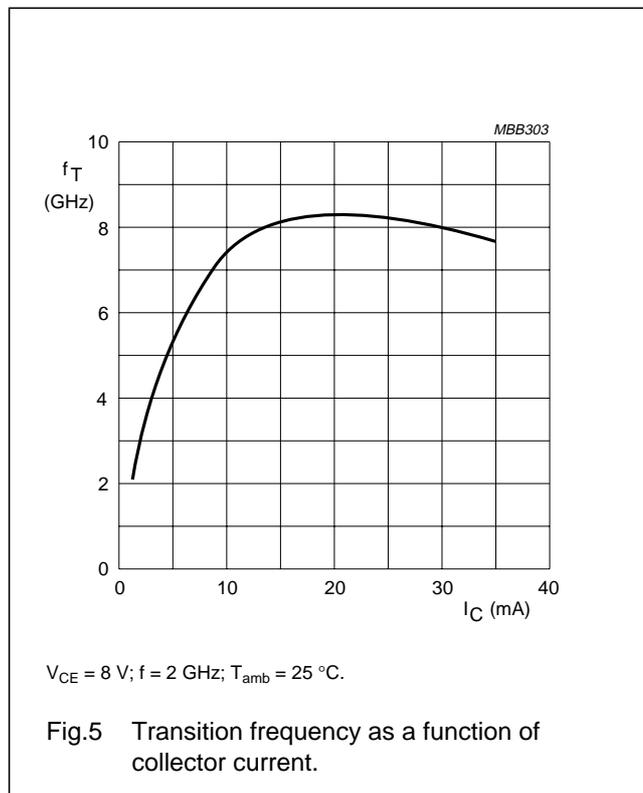
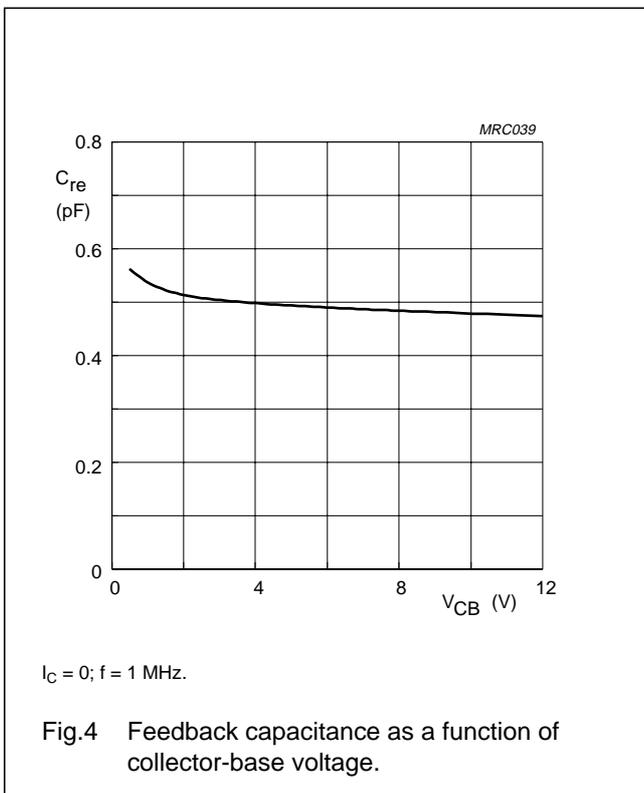
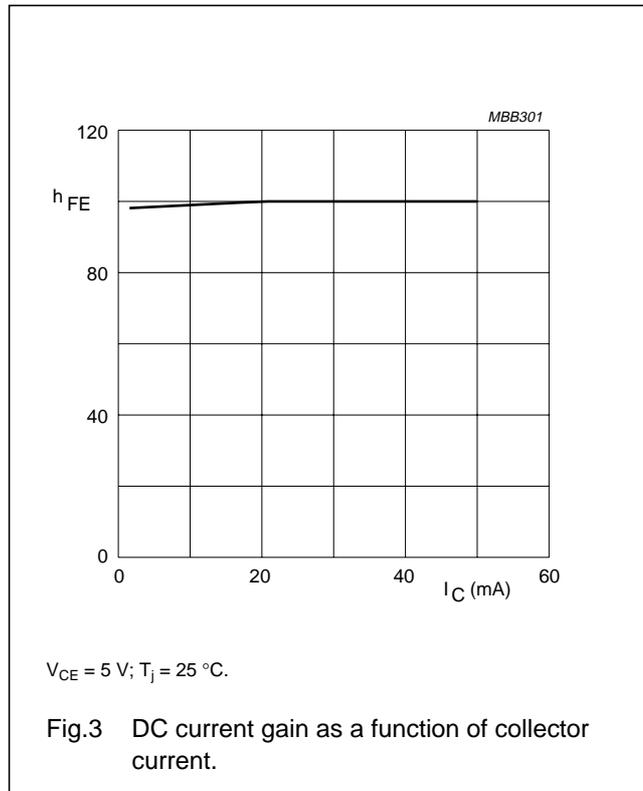
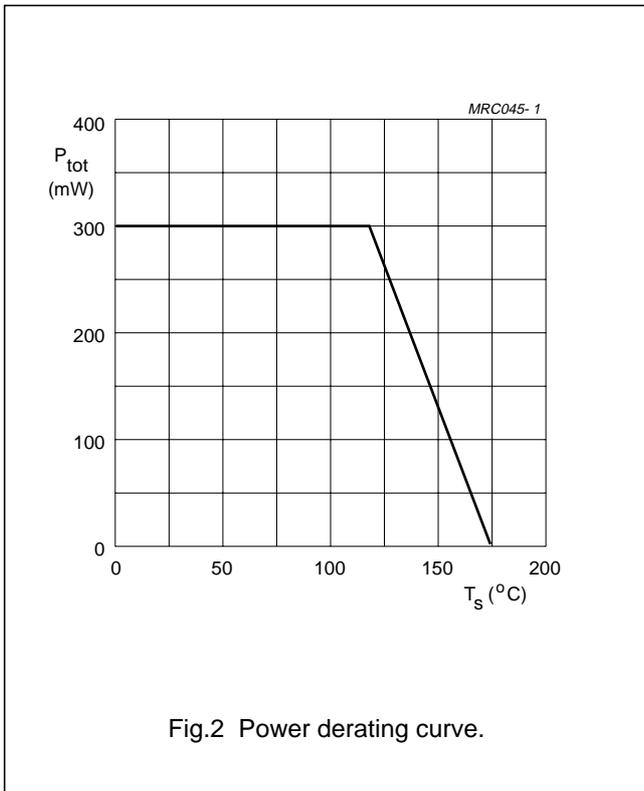

NPN 8 GHz wideband transistor

BFQ67W

In Figs 6 to 9, G_{UM} = maximum unilateral power gain; MSG = maximum stable gain; G_{max} = maximum available gain.

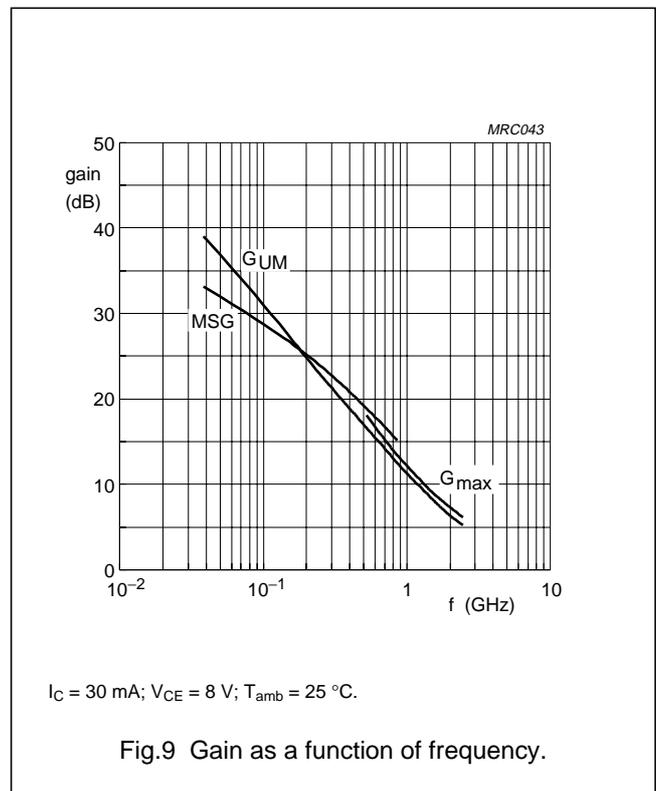
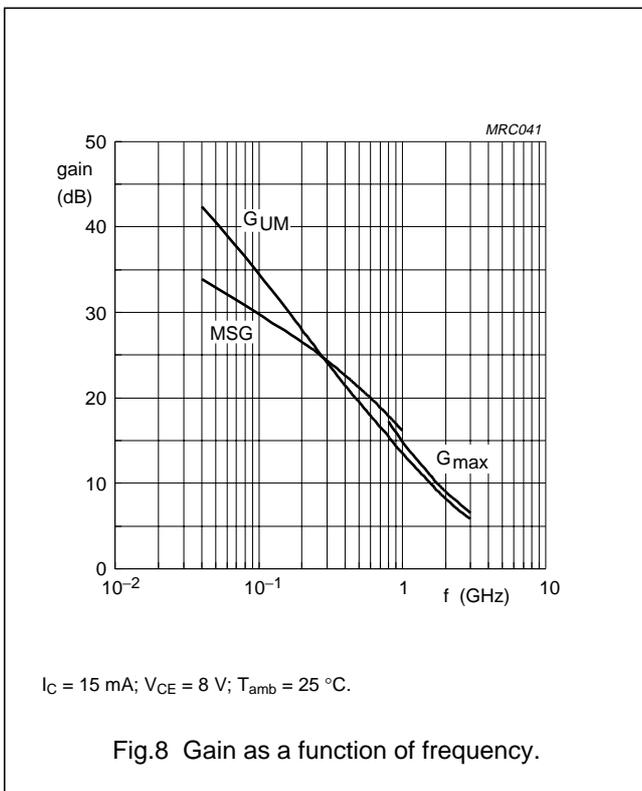
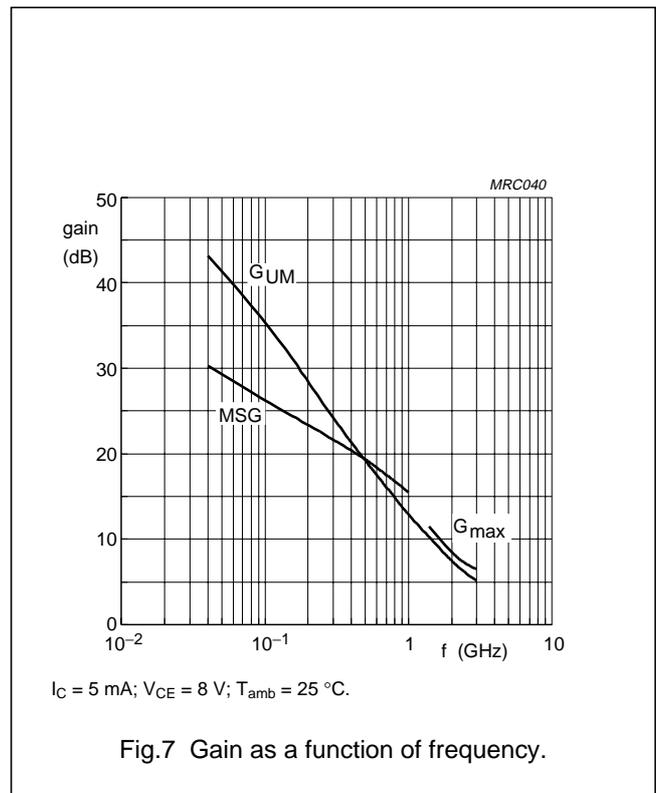
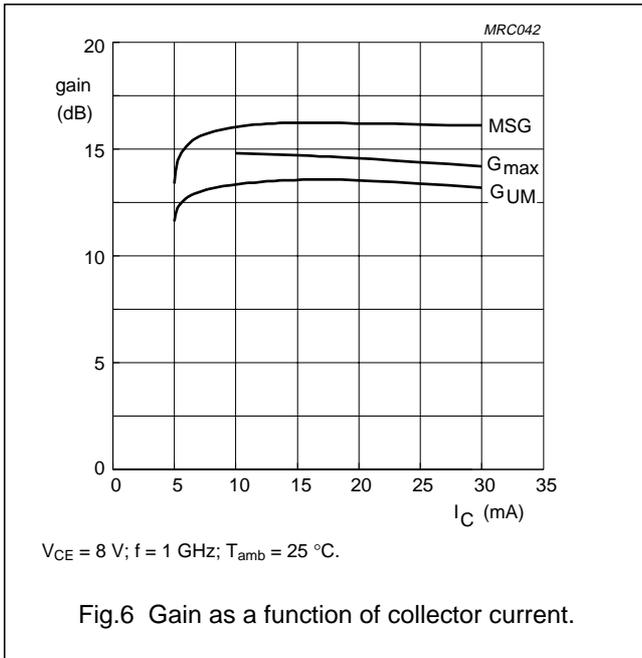

NPN 8 GHz wideband transistor

BFQ67W

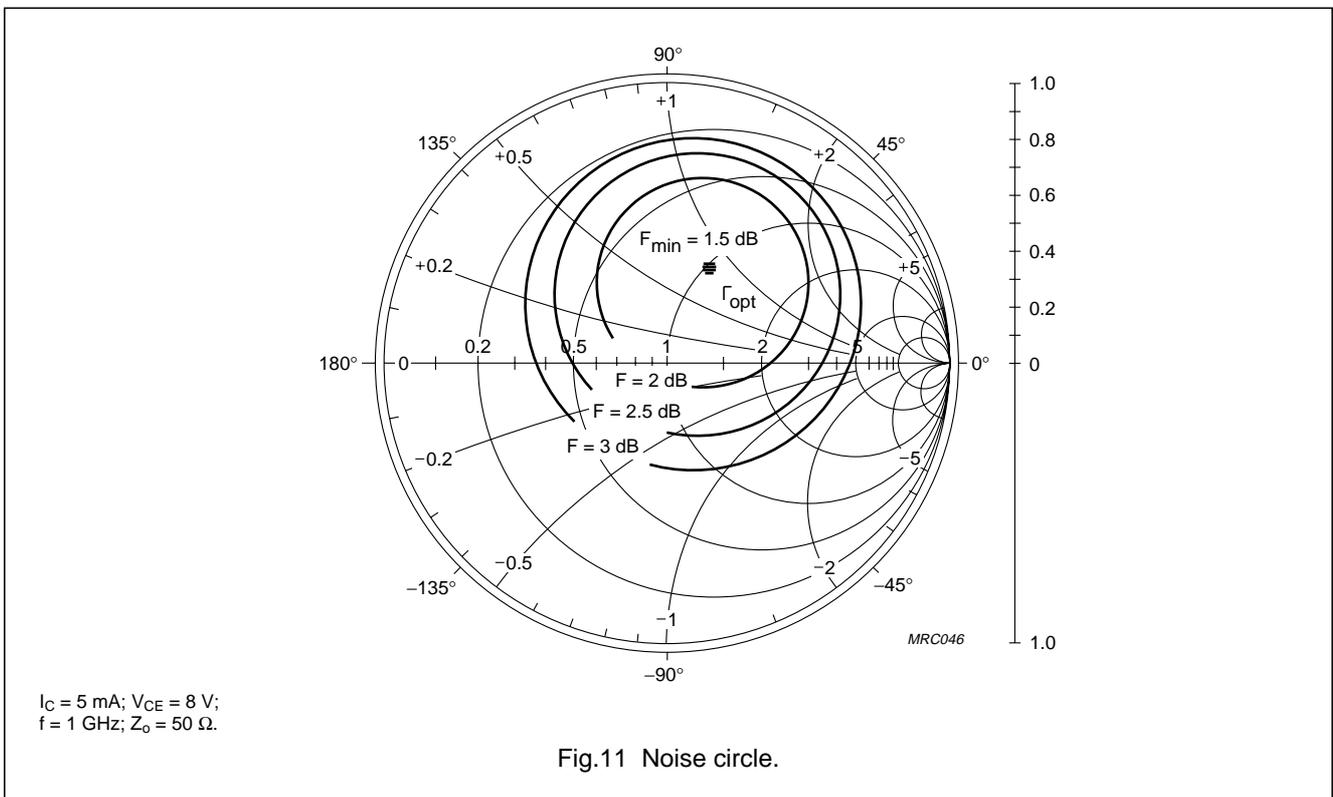
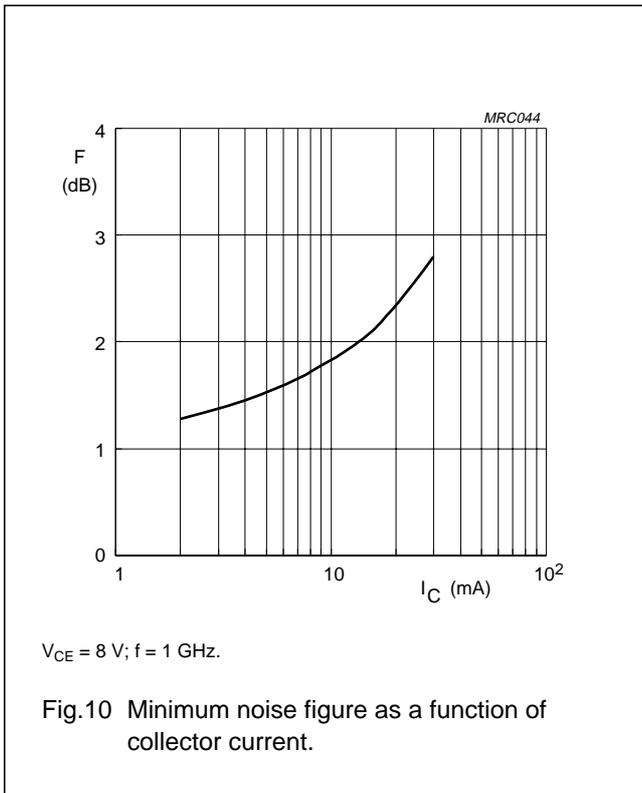

NPN 8 GHz wideband transistor

BFQ67W

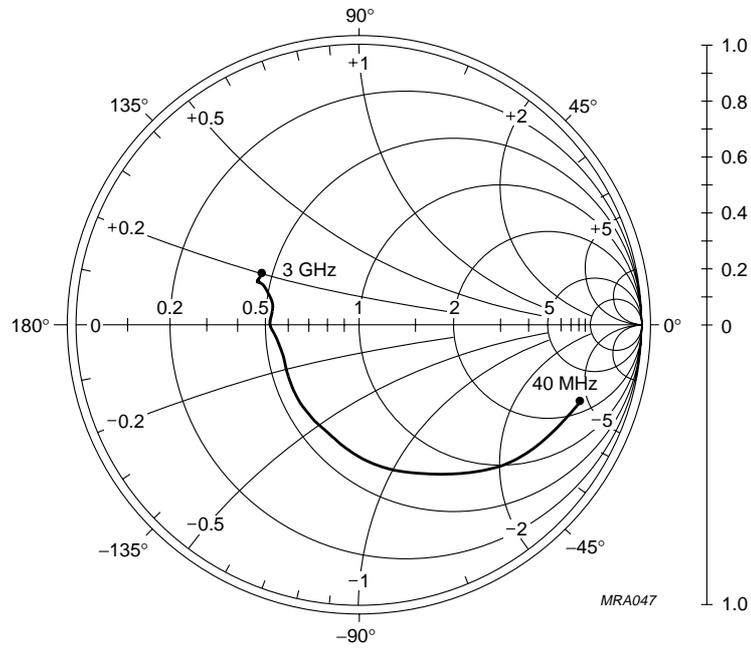

$I_C = 15 \text{ mA}; V_{CE} = 8 \text{ V}; Z_0 = 50 \Omega.$

Fig.12 Common emitter input reflection coefficient (S_{11}).

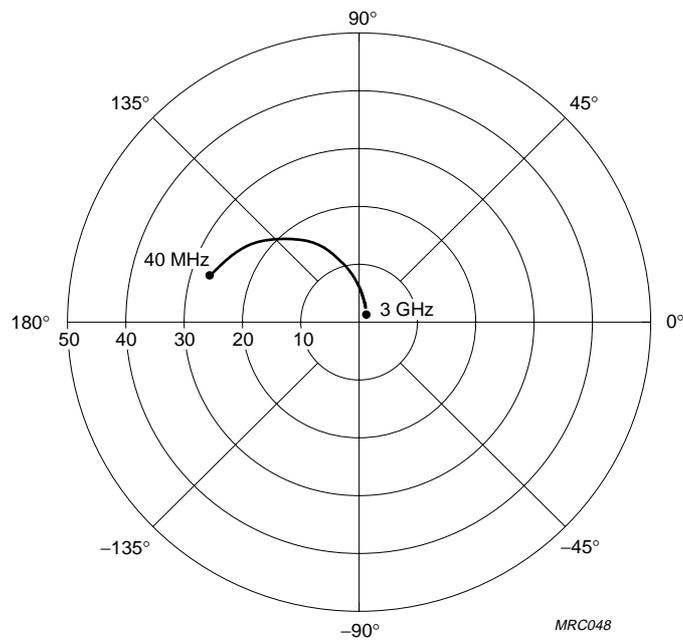

$I_C = 15 \text{ mA}; V_{CE} = 8 \text{ V}.$

Fig.13 Common emitter forward transmission coefficient (S_{21}).

NPN 8 GHz wideband transistor

BFQ67W

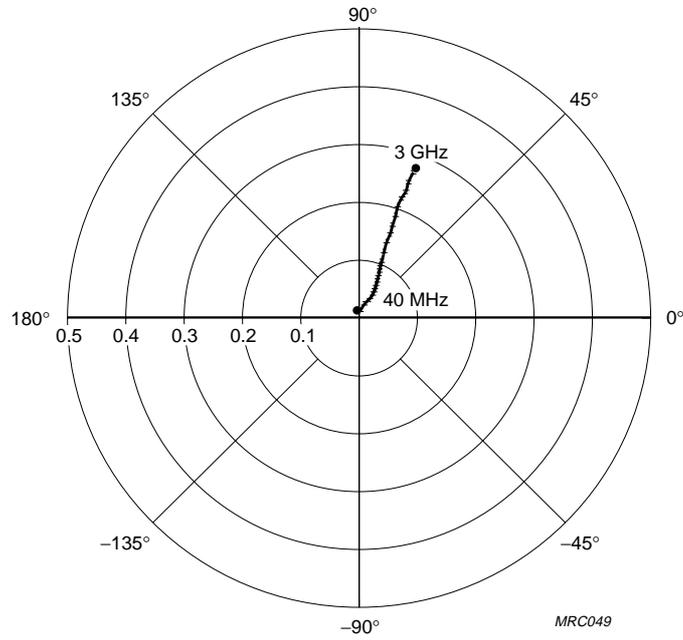

$I_C = 15 \text{ mA}; V_{CE} = 8 \text{ V}.$

Fig.14 Common emitter reverse transmission coefficient (S_{12}).

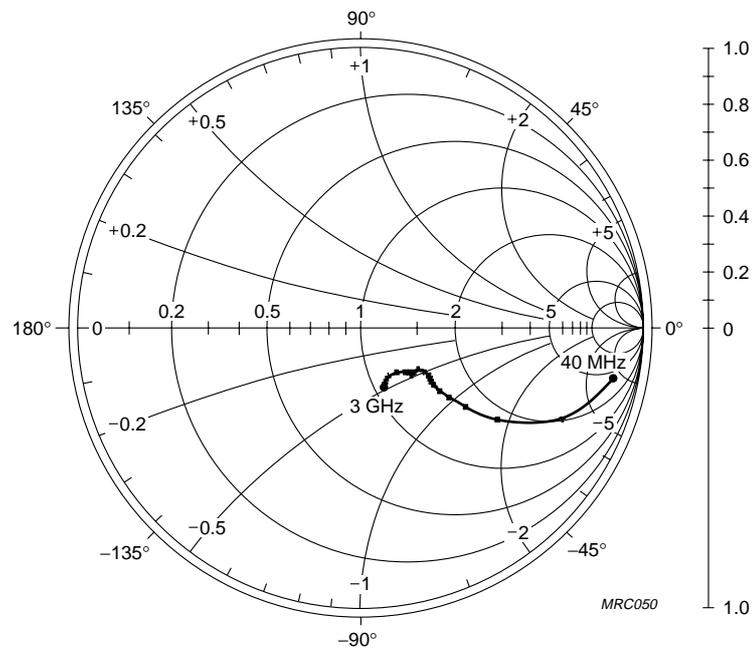

$I_C = 15 \text{ mA}; V_{CE} = 8 \text{ V}; Z_o = 50 \Omega.$

Fig.15 Common emitter output reflection coefficient (S_{22}).

NPN 8 GHz wideband transistor

BFQ67W

PACKAGE OUTLINE

Plastic surface mounted package; 3 leads

SOT323

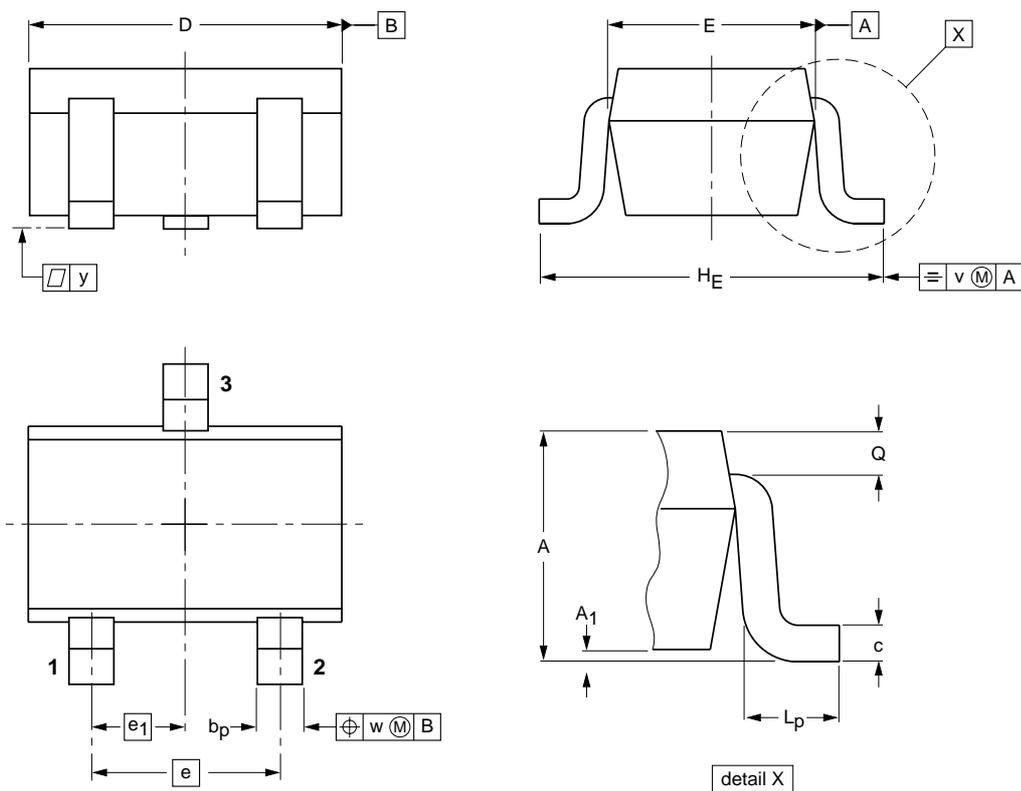

DIMENSIONS (mm are the original dimensions)

UNIT	A	A ₁ max	b _p	c	D	E	e	e ₁	H _E	L _p	Q	v	w
mm	1.1 0.8	0.1	0.4 0.3	0.25 0.10	2.2 1.8	1.35 1.15	1.3	0.65	2.2 2.0	0.45 0.15	0.23 0.13	0.2	0.2

OUTLINE VERSION	REFERENCES				EUROPEAN PROJECTION	ISSUE DATE
	IEC	JEDEC	EIAJ			
SOT323			SC-70			97-02-28

NPN 8 GHz wideband transistor

BFQ67W

DEFINITIONS

Data Sheet Status	
Objective specification	This data sheet contains target or goal specifications for product development.
Preliminary specification	This data sheet contains preliminary data; supplementary data may be published later.
Product specification	This data sheet contains final product specifications.
Limiting values	
Limiting values given are in accordance with the Absolute Maximum Rating System (IEC 134). Stress above one or more of the limiting values may cause permanent damage to the device. These are stress ratings only and operation of the device at these or at any other conditions above those given in the Characteristics sections of the specification is not implied. Exposure to limiting values for extended periods may affect device reliability.	
Application information	
Where application information is given, it is advisory and does not form part of the specification.	

LIFE SUPPORT APPLICATIONS

These products are not designed for use in life support appliances, devices, or systems where malfunction of these products can reasonably be expected to result in personal injury. Philips customers using or selling these products for use in such applications do so at their own risk and agree to fully indemnify Philips for any damages resulting from such improper use or sale.