

MICROWAVE LOW NOISE, LOW DISTORTION AMPLIFIER
NPN SILICON EPITAXIAL TRANSISTOR

DESCRIPTION

The 2SC4703 is designed for low distortion, low noise RF amplifier operating with low supply voltage ($V_{CE} = 5\text{ V}$). This low distortion characteristic makes it suitable for CATV, tele-communication and other use. It employs surface mount type plastic package, Power Mini Mold (SOT-89).

FEATURES

- Low distortion at low supply voltage.
 $IM_2 -55\text{ dB TYP.}$, $IM_3 -76\text{ dB TYP.}$
 $@V_{CE} = 5\text{ V}$, $I_c = 50\text{ mA}$, $V_o = 105\text{ dB}_{\mu/75\Omega}$
- Large P_T with surface mount type package.

ABSOLUTE MAXIMUM RATINGS ($T_A = 25\text{ }^\circ\text{C}$)

Collector to Base Voltage	V_{CBO}	25	V
Collector to Emitter Voltage	V_{CEO}	12	V
Emitter to Base Voltage	V_{EBO}	2.5	V
Collector Current	I_c	150	mA
Total Power Dissipation	P_T	1.8	W
Junction Temperature	T_j	150	$^\circ\text{C}$
Storage Temperature	T_{stg}	-55 to +150	$^\circ\text{C}$

* $0.7\text{ mm} \times 16\text{ cm}^2$ double sided ceramic substrate. (Copper plating)

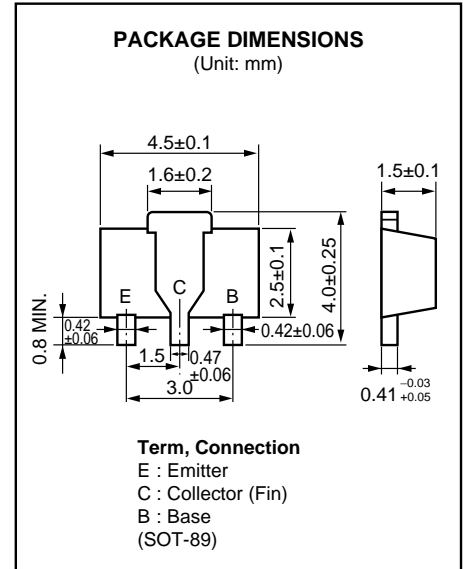

ELECTRICAL CHARACTERISTICS (T_A = 25 °C)

CHARACTERISTIC	SYMBOL	MIN.	TYP.	MAX.	UNIT	TEST CONDITIONS
Collector Cutoff Current	I _{CBO}			1.5	μA	V _{CB} = 20 V, I _E = 0
Emitter Cutoff Current	I _{EB0}			1.5	μA	V _{EB} = 2 V, I _C = 0
DC Current Gain	h _{FE}	50		250		V _{CE} = 5 V, I _C = 5 mA *1
Gain Bandwidth Product	f _T		6.0		GHz	V _{CE} = 5 V, I _C = 5 mA
Collector Capacitance *2	C _{ob}		1.5	2.5	pF	V _{CB} = 5 V, I _E = 0, f = 1 MHz
Insertion Gain	S _{21e} ²	6.5	8.3		dB	V _{CE} = 5 V, I _C = 50 mA, f = 1 GHz
			8.5			V _{CE} = 10 V, I _C = 20 mA, f = 1 GHz
Noise Figure	NF		2.3	3.5	dB	V _{CE} = 5 V, I _C = 50 mA, f = 1 GHz
2nd Order Intermodulation Distortion	IM ₂		-55		dB	V _{CE} = 5 V, I _C = 50 mA, V _O = 105 dBμ/75Ω
			-63			V _{CE} = 10 V, f = 190 MHz - 90 MHz
3rd Order Intermodulation Distortion	IM ₃		-76		dB	V _{CE} = 5 V, I _C = 50 mA, V _O = 105 dBμ/75Ω
			-81			V _{CE} = 10 V, f = 2 × 190 MHz - 200 MHz

*1 Puls Measurement PW ≤ 350 μs, Duty Cycle ≤ 2 %

*2 Emitter terminal should be connected to the guard terminal of the three terminal capacitance bridge.

h_{FE} Classification

Class	SH	SF	SE
Marking	SH	SF	SE
h _{FE}	50 to 100	80 to 160	125 to 250

TYPICAL CHARACTERISTICS (T_A = 25 °C)

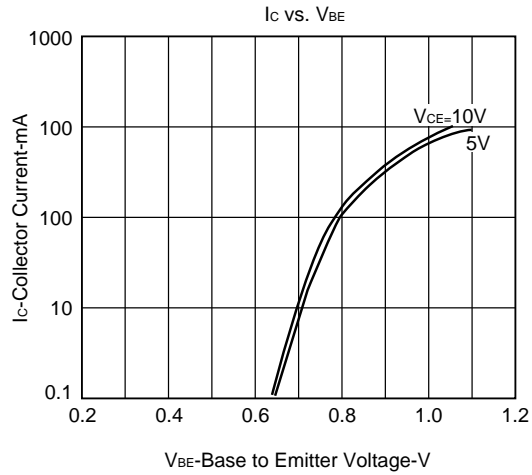
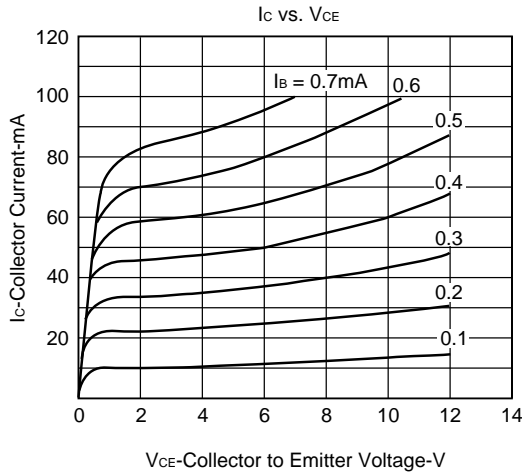

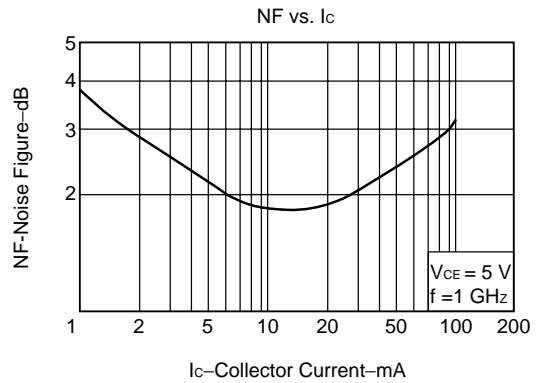
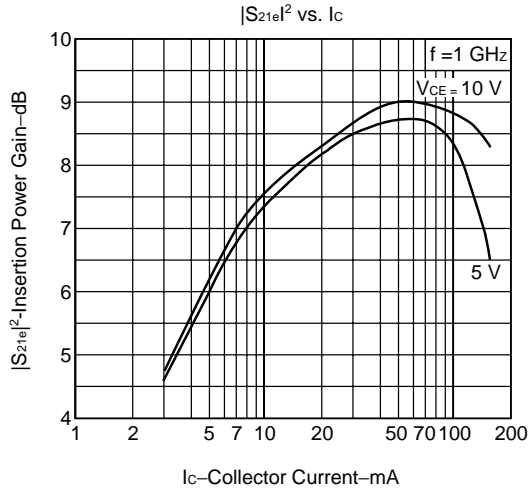
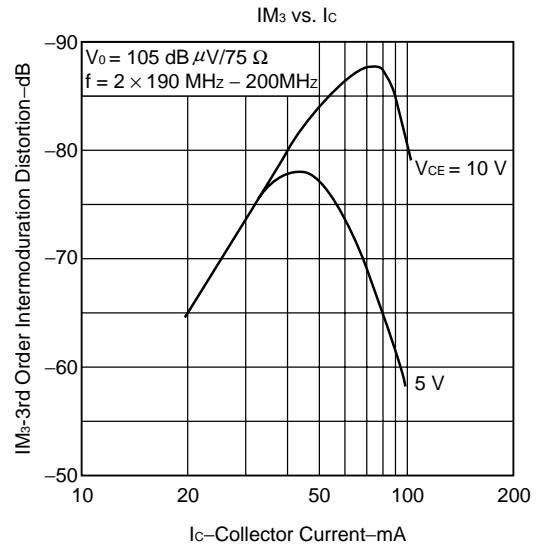
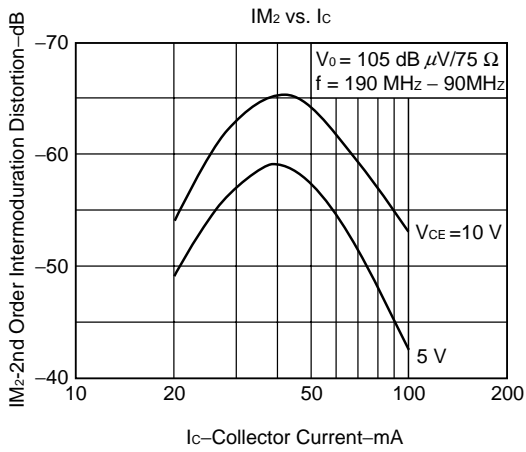
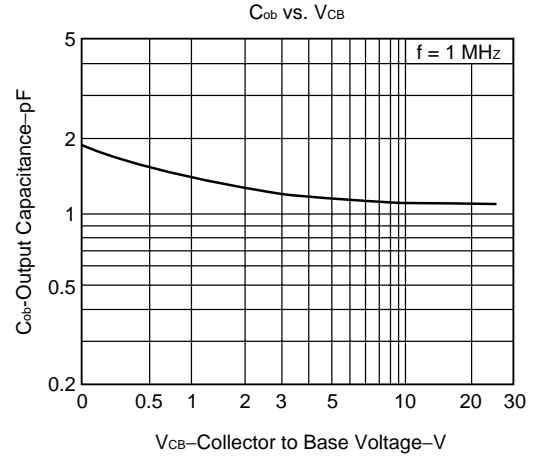
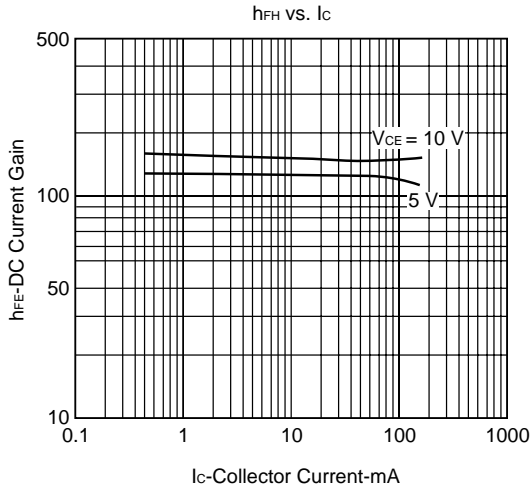

S-PARAMETER

2SC4073 5V 50mA

FREQUENCY MHz	S ₁₁		S ₂₁		S ₁₂		S ₂₂	
	MAG	ANG	MAG	ANG	MAG	ANG	MAG	ANG
100.00	0.641	-66.7	17.277	127.9	0.053	67.6	0.694	-45.3
200.00	0.426	-102.5	10.572	110.0	0.071	61.2	0.452	-60.2
300.00	0.345	-125.2	8.139	98.5	0.093	54.5	0.342	-69.7
400.00	0.306	-144.0	5.907	88.8	0.105	54.8	0.262	-77.4
500.00	0.288	-157.1	4.897	84.2	0.123	59.1	0.254	-80.5
600.00	0.276	-169.2	4.054	79.5	0.145	59.5	0.214	-86.2
700.00	0.278	178.7	3.711	75.8	0.172	58.6	0.203	-89.2
800.00	0.276	171.9	3.207	68.7	0.184	55.9	0.187	-94.5
900.00	0.297	162.4	2.836	65.8	0.199	57.6	0.182	-89.7
1000.00	0.278	156.6	2.598	63.2	0.223	57.2	0.173	-100.9
1100.00	0.295	149.6	2.444	59.0	0.253	55.1	0.174	-103.0
1200.00	0.285	142.4	2.244	54.7	0.266	52.6	0.174	-109.9
1300.00	0.308	137.8	2.051	51.3	0.274	51.9	0.178	-114.4
1400.00	0.315	131.2	1.939	50.4	0.294	52.9	0.173	-121.0
1500.00	0.329	128.2	1.916	45.1	0.329	49.3	0.177	-125.8
1600.00	0.328	122.6	1.745	42.4	0.332	47.0	0.175	-126.7
1700.00	0.344	121.4	1.680	39.1	0.352	45.4	0.189	-133.7
1800.00	0.349	116.4	1.581	38.6	0.361	46.2	0.195	-137.8
1900.00	0.360	113.8	1.627	34.5	0.402	43.3	0.198	-141.8
2000.00	0.370	109.3	1.455	30.8	0.393	40.6	0.189	-147.2

2SC4073 5V 100mA

FREQUENCY MHz	S ₁₁		S ₂₁		S ₁₂		S ₂₂	
	MAG	ANG	MAG	ANG	MAG	ANG	MAG	ANG
100.00	0.614	-74.1	17.789	124.8	0.048	62.1	0.651	-50.7
200.00	0.400	-109.1	10.554	107.4	0.065	58.1	0.398	-64.4
300.00	0.339	-133.0	8.039	96.5	0.092	56.2	0.303	-73.7
400.00	0.306	-150.7	5.810	87.2	0.104	55.9	0.234	-82.1
500.00	0.294	-163.7	4.803	82.8	0.124	60.1	0.230	-85.0
600.00	0.284	-174.6	3.970	78.2	0.145	60.1	0.194	-91.6
700.00	0.289	173.9	3.627	74.7	0.173	59.3	0.183	-95.5
800.00	0.288	167.7	3.143	67.6	0.187	56.6	0.173	-100.5
900.00	0.312	159.1	2.775	64.8	0.202	58.0	0.169	-105.1
1000.00	0.293	153.7	2.542	62.3	0.227	57.3	0.161	-107.5
1100.00	0.311	147.5	2.391	58.1	0.256	55.8	0.161	-109.4
1200.00	0.302	140.2	2.195	53.9	0.273	53.0	0.165	-115.5
1300.00	0.324	136.1	2.006	50.4	0.282	51.7	0.168	-121.2
1400.00	0.329	130.0	1.896	49.5	0.300	52.4	0.165	-127.0
1500.00	0.344	126.9	1.879	44.4	0.335	49.5	0.171	-131.9
1600.00	0.343	121.5	1.709	41.6	0.338	47.2	0.167	-133.4
1700.00	0.358	120.1	1.647	38.4	0.359	44.8	0.183	-139.9
1800.00	0.364	115.7	1.547	37.9	0.366	45.6	0.188	-143.4
1900.00	0.374	112.9	1.597	33.8	0.410	42.8	0.198	-147.6
2000.00	0.385	108.4	1.428	30.1	0.398	40.3	0.185	-153.4

S-PARAMETER

2SC4073 10V 50mA

FREQUENCY MHz	S ₁₁		S ₂₁		S ₁₂		S ₂₂	
	MAG	ANG	MAG	ANG	MAG	ANG	MAG	ANG
100.00	0.642	-64.7	17.702	128.9	0.047	67.3	0.688	-43.8
200.00	0.417	-98.0	10.932	110.9	0.067	58.8	0.446	-57.5
300.00	0.335	-120.3	8.436	99.2	0.091	56.0	0.347	-66.6
400.00	0.287	-139.6	6.135	89.7	0.103	55.4	0.271	-72.5
500.00	0.268	-152.8	5.094	85.0	0.122	60.1	0.262	-75.8
600.00	0.254	-165.6	4.214	80.2	0.141	59.2	0.220	-81.4
700.00	0.252	-178.6	3.851	76.8	0.167	59.1	0.208	-83.6
800.00	0.251	174.1	3.333	69.6	0.180	56.7	0.192	-89.1
900.00	0.272	164.0	2.952	66.6	0.196	58.4	0.186	-92.0
1000.00	0.255	158.1	2.696	64.1	0.218	58.1	0.176	-93.9
1100.00	0.269	150.7	2.532	60.1	0.247	55.8	0.177	-96.0
1200.00	0.262	142.8	2.326	55.8	0.263	53.5	0.178	-103.4
1300.00	0.283	138.2	2.124	52.4	0.273	52.5	0.178	-107.1
1400.00	0.291	131.8	2.007	51.4	0.289	53.7	0.175	-113.2
1500.00	0.305	129.0	1.985	46.3	0.324	49.8	0.179	-117.9
1600.00	0.305	122.7	1.806	43.5	0.325	48.1	0.173	-119.6
1700.00	0.320	121.6	1.739	40.4	0.347	45.9	0.187	-127.0
1800.00	0.325	116.7	1.636	39.9	0.355	46.7	0.194	-130.1
1900.00	0.336	113.8	1.682	35.7	0.397	44.3	0.194	-135.6
2000.00	0.348	109.4	1.504	32.1	0.388	41.5	0.183	-140.6

2SC4073 10V 100mA

FREQUENCY MHz	S ₁₁		S ₂₁		S ₁₂		S ₂₂	
	MAG	ANG	MAG	ANG	MAG	ANG	MAG	ANG
100.00	0.625	-70.1	18.613	125.5	0.049	59.7	0.658	-48.1
200.00	0.395	-104.9	11.086	108.0	0.068	58.8	0.401	-62.3
300.00	0.317	-127.3	8.456	97.2	0.089	56.8	0.307	-68.5
400.00	0.281	-145.7	6.120	88.0	0.101	57.6	0.240	-75.4
500.00	0.263	-158.8	5.067	83.6	0.122	60.5	0.234	-78.2
600.00	0.255	-171.2	4.185	79.1	0.143	61.1	0.201	-84.6
700.00	0.256	176.4	3.826	75.7	0.170	60.2	0.188	-87.4
800.00	0.254	169.9	3.307	68.7	0.181	57.3	0.175	-92.3
900.00	0.277	160.7	2.920	65.7	0.197	58.7	0.171	-95.6
1000.00	0.261	154.8	2.673	63.3	0.222	58.4	0.165	-97.1
1100.00	0.277	148.4	2.510	59.2	0.251	56.7	0.164	-99.9
1200.00	0.269	140.7	2.306	55.0	0.266	54.2	0.167	-106.7
1300.00	0.288	135.9	2.106	51.6	0.275	52.8	0.168	-111.6
1400.00	0.297	130.0	1.990	50.8	0.294	53.8	0.163	-117.1
1500.00	0.312	127.1	1.966	45.7	0.327	49.9	0.170	-121.9
1600.00	0.311	121.5	1.788	43.0	0.331	48.0	0.165	-123.7
1700.00	0.327	120.0	1.721	39.8	0.350	45.8	0.178	-131.0
1800.00	0.331	115.5	1.620	39.3	0.359	46.8	0.184	-134.4
1900.00	0.344	112.7	1.669	35.2	0.400	43.7	0.184	-138.7
2000.00	0.356	108.0	1.491	31.5	0.391	41.2	0.177	-144.7

[MEMO]

[MEMO]

No part of this document may be copied or reproduced in any form or by any means without the prior written consent of NEC Corporation. NEC Corporation assumes no responsibility for any errors which may appear in this document.

NEC Corporation does not assume any liability for infringement of patents, copyrights or other intellectual property rights of third parties by or arising from use of a device described herein or any other liability arising from use of such device. No license, either express, implied or otherwise, is granted under any patents, copyrights or other intellectual property rights of NEC Corporation or others.

While NEC Corporation has been making continuous effort to enhance the reliability of its semiconductor devices, the possibility of defects cannot be eliminated entirely. To minimize risks of damage or injury to persons or property arising from a defect in an NEC semiconductor device, customers must incorporate sufficient safety measures in its design, such as redundancy, fire-containment, and anti-failure features.

NEC devices are classified into the following three quality grades:

"Standard", "Special", and "Specific". The Specific quality grade applies only to devices developed based on a customer designated "quality assurance program" for a specific application. The recommended applications of a device depend on its quality grade, as indicated below. Customers must check the quality grade of each device before using it in a particular application.

Standard: Computers, office equipment, communications equipment, test and measurement equipment, audio and visual equipment, home electronic appliances, machine tools, personal electronic equipment and industrial robots

Special: Transportation equipment (automobiles, trains, ships, etc.), traffic control systems, anti-disaster systems, anti-crime systems, safety equipment and medical equipment (not specifically designed for life support)

Specific: Aircrafts, aerospace equipment, submersible repeaters, nuclear reactor control systems, life support systems or medical equipment for life support, etc.

The quality grade of NEC devices is "Standard" unless otherwise specified in NEC's Data Sheets or Data Books. If customers intend to use NEC devices for applications other than those specified for Standard quality grade, they should contact an NEC sales representative in advance.

Anti-radioactive design is not implemented in this product.

This datasheet has been download from:

www.datasheetcatalog.com

Datasheets for electronics components.