

**SP1002 Series 5pF 8kV Bidirectional TVS Array**

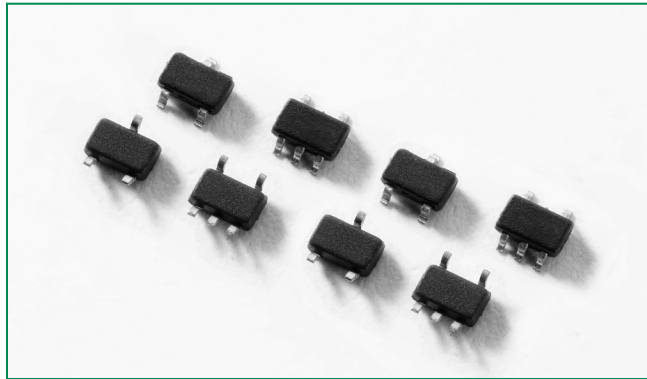

**Description**

Back-to-Back Zener diodes fabricated in a proprietary silicon avalanche technology protect each I/O pin to provide a high level of protection for electronic equipment that may experience destructive electrostatic discharges (ESD). These robust diodes can safely absorb repetitive ESD strikes at the maximum level specified in the IEC 61000-4-2 international standard (Level 4, ±8kV contact discharge) without performance degradation. Their very low loading capacitance also makes them ideal for protecting high-speed signal pins.

**Pinout**

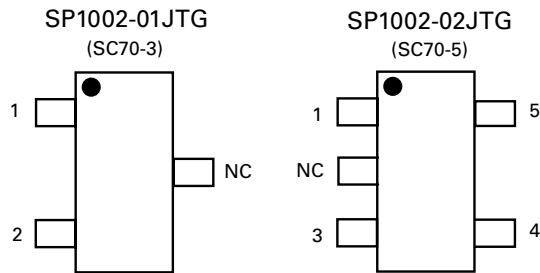

**Features**

- Low capacitance of 5pF (TYP) I/O to I/O
- ESD protection of ±8kV contact discharge, ±15kV air discharge, (Level 4, IEC 61000-4-2)
- EFT protection, IEC 61000-4-4, 40A (5/50ns)
- Low leakage current of 0.5µA (MAX) at 5V
- Small package saves board space
- Lightning Protection, IEC 61000-4-5, 2nd edition 2A (8/20µs)
- RoHS compliant and lead free

**Functional Block Diagram**

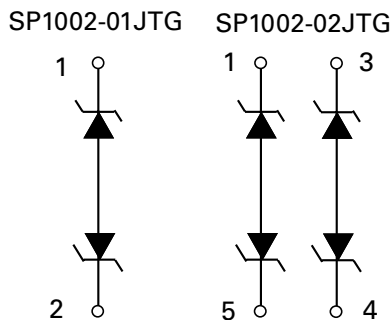

**Applications**

- Computer Peripherals
- Mobile Phones
- Digital Cameras
- Desktops/Notebooks
- LCD/PDPTVs
- Set Top Boxes
- DVD Players
- MP3/PMP

**Application Example**

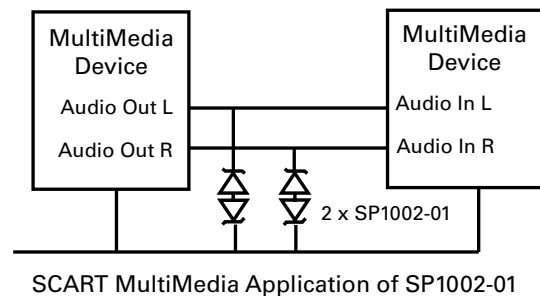

**Additional Information**



Life Support Note:

**Not Intended for Use in Life Support or Life Saving Applications**

The products shown herein are not designed for use in life sustaining or life saving applications unless otherwise expressly indicated.

### Absolute Maximum Ratings

Symbol	Parameter	Value	Units
$I_{PP}$	Peak Current ( $t_p=8/20\mu s$ )	2	A
$T_{OP}$	Operating Temperature	-40 to 125	°C
$T_{STOR}$	Storage Temperature	-55 to 150	°C

CAUTION: Stresses above those listed in "Absolute Maximum Ratings" may cause permanent damage to the device. This is a stress only rating and operation of the device at these or any other conditions above those indicated in the operational sections of this specification is not implied.

### Thermal Information

Parameter	Rating	Units
Storage Temperature Range	-55 to 150	°C
Maximum Junction Temperature	150	°C
Maximum Lead Temperature (Soldering 20-40s)	260	°C

### Electrical Characteristics ( $T_{OP} = 25^\circ C$ )

Parameter	Symbol	Test Conditions	Min	Typ	Max	Units
Voltage Drop	$V_D$	$I_R=1mA$	6.0		9.5	V
Reverse Standoff Voltage	$V_{RWM}$	$I_R \leq 1\mu A$ with 1 I/O at GND			6.0	V
Leakage Current	$I_{LEAK}$	$V_R=5V$ with I/O at GND			0.5	$\mu A$
Clamp Voltage <sup>1</sup>	$V_C$	$I_{PP}=1A, t_p=8/20\mu s$ , Fwd		9.2	13.0	V
		$I_{PP}=2A, t_p=8/20\mu s$ , Fwd		11.2	16.0	V
Dynamic Resistance	$R_{DYN}$	$(V_{C2} - V_{C1}) / (I_{PP2} - I_{PP1})$		2.0		$\Omega$
ESD Withstand Voltage <sup>1,2</sup>	$V_{ESD}$	IEC61000-4-2 (Contact)	$\pm 8$			kV
		IEC61000-4-2 (Air)	$\pm 15$			kV
Diode Capacitance <sup>1</sup>	$C_D$	Reverse Bias=0V		6		pF
		Reverse Bias=2.5V		5		pF
		Reverse Bias=5V		5		pF

Notes:

<sup>1</sup> Parameter is guaranteed by device characterization

<sup>2</sup> A minimum of 1,000 ESD pulses are applied at 1s intervals

### Soldering Parameters

Reflow Condition	Pb – Free assembly	
Pre Heat	- Temperature Min ( $T_{s(min)}$ )	150°C
	- Temperature Max ( $T_{s(max)}$ )	200°C
	- Time (min to max) ( $t_s$ )	60 – 180 secs
Average ramp up rate (Liquidus) Temp ( $T_L$ ) to peak	3°C/second max	
$T_{s(max)}$ to $T_L$ - Ramp-up Rate	3°C/second max	
Reflow	- Temperature ( $T_L$ ) (Liquidus)	217°C
	- Temperature ( $t_t$ )	60 – 150 seconds
Peak Temperature ( $T_p$ )	260 <sup>+0/-5</sup> °C	
Time within 5°C of actual peak Temperature ( $t_p$ )	20 – 40 seconds	
Ramp-down Rate	6°C/second max	
Time 25°C to peak Temperature ( $T_p$ )	8 minutes max.	
Do not exceed	260°C	

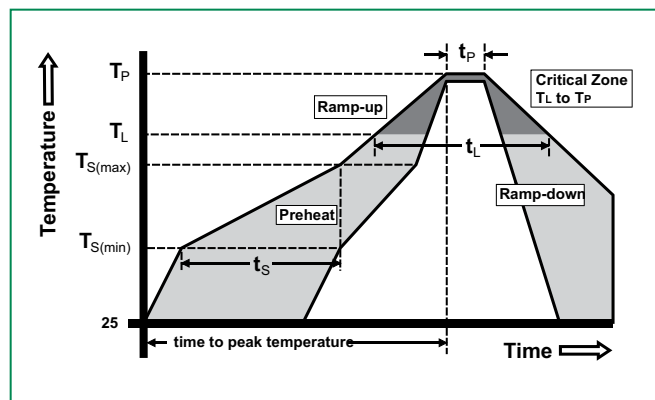

**Package Dimensions — SC70-3**

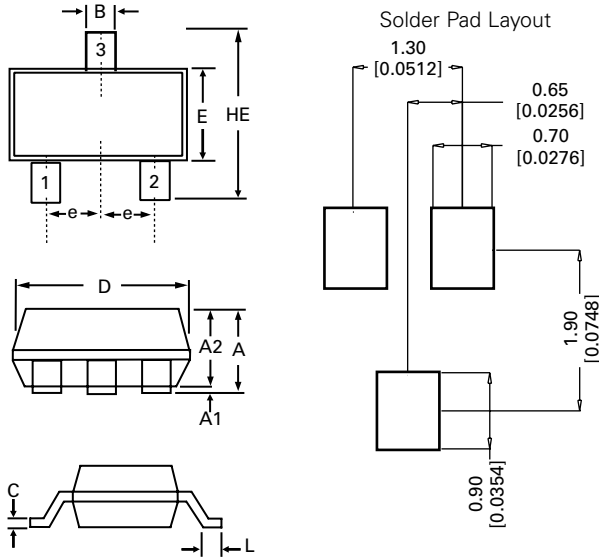

Package	SC70-3			
Pins	3			
JEDEC	MO-203			
	Millimeters		Inches	
	Min	Max	Min	Max
<b>A</b>	0.80	1.10	0.031	0.043
<b>A1</b>	0.00	0.10	0.000	0.004
<b>A2</b>	0.70	1.00	0.028	0.039
<b>B</b>	0.15	0.30	0.006	0.012
<b>c</b>	0.08	0.25	0.003	0.010
<b>D</b>	1.85	2.25	0.073	0.089
<b>E</b>	1.15	1.35	0.045	0.053
<b>e</b>	0.66 BSC		0.026 BSC	
<b>HE</b>	2.00	2.40	0.079	0.094
<b>L</b>	0.26	0.46	0.010	0.018

**Package Dimensions — SC70-5**

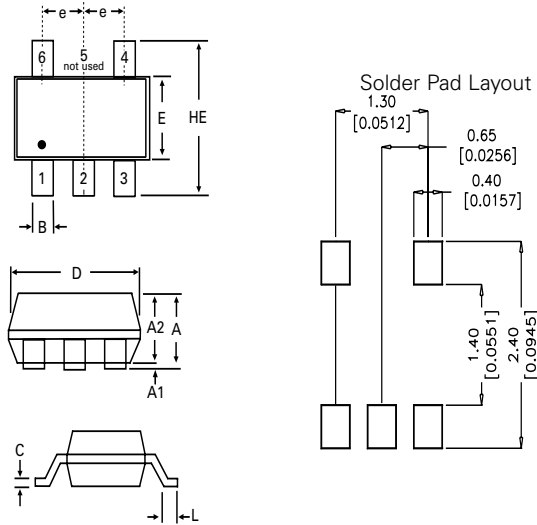

Package	SC70-5			
Pins	5			
JEDEC	MO-203			
	Millimeters		Inches	
	Min	Max	Min	Max
<b>A</b>	0.80	1.10	0.031	0.043
<b>A1</b>	0.00	0.10	0.000	0.004
<b>A2</b>	0.70	1.00	0.028	0.039
<b>B</b>	0.15	0.30	0.006	0.012
<b>c</b>	0.08	0.25	0.003	0.010
<b>D</b>	1.85	2.25	0.073	0.089
<b>E</b>	1.15	1.35	0.045	0.053
<b>e</b>	0.65 BSC		0.026 BSC	
<b>HE</b>	2.00	2.40	0.079	0.094
<b>L</b>	0.26	0.46	0.010	0.018

**Product Characteristics**

<b>Lead Plating</b>	Matte Tin
<b>Lead Material</b>	Copper Alloy
<b>Lead Coplanarity</b>	0.0004 inches (0.102mm)
<b>Substitute Material</b>	Silicon
<b>Body Material</b>	Molded Epoxy
<b>Flammability</b>	UL 94 V-0

Notes :

1. All dimensions are in millimeters
2. Dimensions include solder plating.
3. Dimensions are exclusive of mold flash & metal burr.
4. Blo is facing up for mold and facing down for trim/form, i.e. reverse trim/form.
5. Package surface matte finish VDI 11-13.

**Part Numbering System**

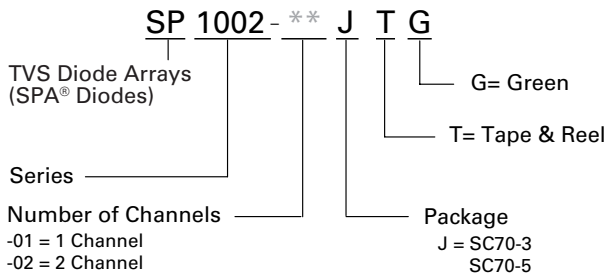

**Part Marking System**

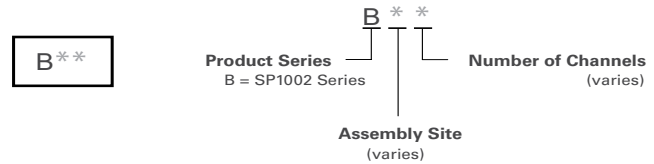

**Ordering Information**

Part Number	Package	Marking	Min. Order Qty.
SP1002-01JTG	SC70-3	B*1	3000
SP1002-02JTG	SC70-5	B*2	3000

**Embossed Carrier Tape & Reel Specification – SC70-3**

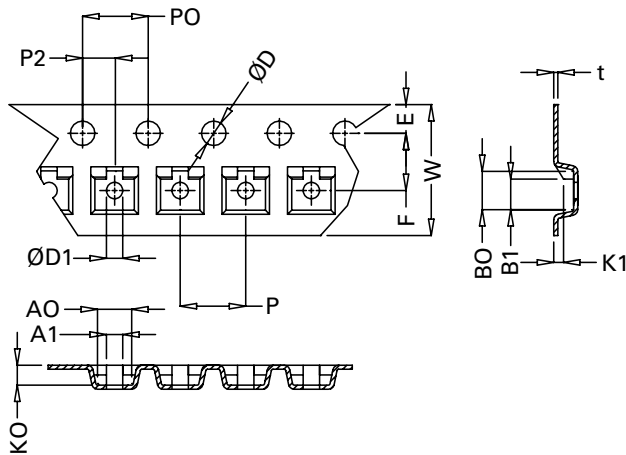

	Millimetres		Inches	
	Min	Max	Min	Max
<b>E</b>	1.65	1.85	0.065	0.073
<b>F</b>	3.45	3.55	0.135	0.139
<b>P2</b>	1.95	2.05	0.077	0.081
<b>D</b>	1.40	1.60	0.055	0.063
<b>D1</b>	1.00	1.25	0.039	0.049
<b>P0</b>	3.90	4.10	0.154	0.161
<b>10P0</b>	40.0 ± 0.20		1.574 ± 0.008	
<b>W</b>	7.70	8.10	0.303	0.318
<b>P</b>	3.90	4.10	0.153	0.161
<b>A0</b>	2.30	2.50	0.090	0.098
<b>A1</b>	1.00 Ref		0.039 Ref	
<b>B0</b>	2.30	2.50	0.090	0.098
<b>B1</b>	1.90 Ref		0.074	
<b>K0</b>	1.10	1.30	0.043	0.051
<b>K1</b>	0.60 Ref		0.023 Ref	
<b>t</b>	0.27 max		0.010	

**Embossed Carrier Tape & Reel Specification – SC70-5 and SC70-6**

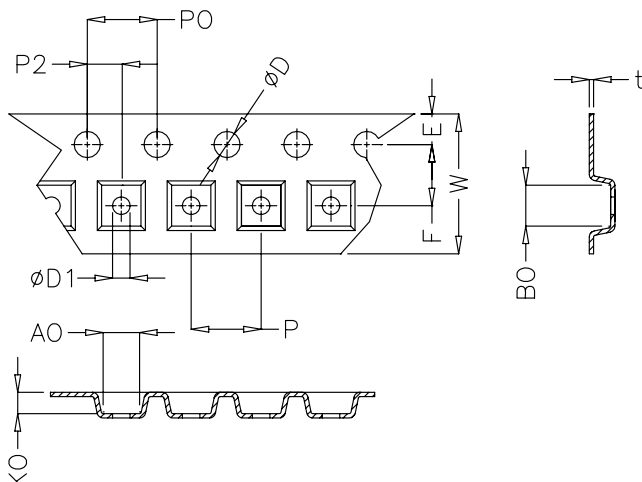

	Millimetres		Inches	
	Min	Max	Min	Max
<b>E</b>	1.65	1.85	0.065	0.073
<b>F</b>	3.45	3.55	0.135	0.139
<b>P2</b>	1.95	2.05	0.077	0.081
<b>D</b>	1.40	1.60	0.055	0.063
<b>D1</b>	1.00	1.25	0.039	0.049
<b>P0</b>	3.90	4.10	0.154	0.161
<b>10P0</b>	40.0 ± 0.20		1.574 ± 0.008	
<b>W</b>	7.70	8.10	0.303	0.318
<b>P</b>	3.90	4.10	0.153	0.161
<b>A0</b>	2.14	2.34	0.084	0.092
<b>B0</b>	2.24	2.44	0.088	0.096
<b>K0</b>	1.12	1.32	0.044	0.052
<b>t</b>	0.27 max		0.010 max	

**Disclaimer Notice - Information furnished is believed to be accurate and reliable. However, users should independently evaluate the suitability of and test each product selected for their own applications. Littelfuse products are not designed for, and may not be used in, all applications. Read complete Disclaimer Notice at [www.littelfuse.com/disclaimer-electronics](http://www.littelfuse.com/disclaimer-electronics).**