

PNP General Purpose Transistors

 Lead(Pb)-Free

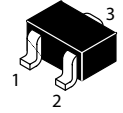
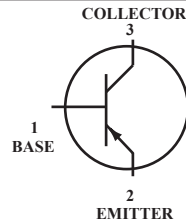

SOT-323(SC-70)

MAXIMUM RATINGS

Rating	Symbol	Value	Unit
Collector-Emitter Voltage	V_{CE0}	-60	Vdc
Collector-Base Voltage	V_{CB0}	-60	Vdc
Emitter-Base Voltage	V_{EB0}	-5.0	Vdc
Collector Current-Continuous	I_C	-600	mAdc

THERMAL CHARACTERISTICS

Characteristics	Symbol	Max	Unit
Total Device Dissipation FR-5 Board (1) $T_A=25^{\circ}\text{C}$	P_D	150	mW
Thermal Resistance, Junction to Ambient	$R_{\theta JA}$	833	$^{\circ}\text{C}/\text{W}$
Junction and Storage, Temperature	$T_{J,Tstg}$	-55 to +150	$^{\circ}\text{C}$

DEVICE MARKING

MMBT2907AW=20

ELECTRICAL CHARACTERISTICS

Characteristics	Symbol	Min	Max	Unit
-----------------	--------	-----	-----	------

OFF CHARACTERISTICS

Collector-Emitter Breakdown Voltage ($I_C = -10 \text{ mAdc}$, $I_B = 0$) ⁽²⁾	$V_{(BR)CEO}$	-60	-	Vdc
Collector-Base Breakdown Voltage ($I_C = -10 \mu\text{Adc}$, $I_E = 0$)	$V_{(BR)CBO}$	-60	-	Vdc
Emitter-Base Breakdown Voltage ($I_E = -10 \mu\text{Adc}$, $I_C = 0$)	$V_{(BR)EBO}$	-5.0	-	Vdc
Collector Cutoff Current ($V_{CE} = -30 \text{ Vdc}$, $V_{EB}(\text{off}) = -0.5 \text{ Vdc}$)	I_{CEX}		-50	nAdc
Collector Cutoff Current ($V_{CB} = -50 \text{ Vdc}$, $I_E = 0$) ($V_{CB} = -50 \text{ Vdc}$, $I_E = 0$, $T_A = 125^{\circ}\text{C}$)	I_{CBO}	-	-0.010 -10	nAdc
Base Cutoff Current ($V_{CE} = -30 \text{ Vdc}$, $V_{EB}(\text{off}) = -0.5 \text{ Vdc}$)	I_{BL}	-	-50	nAdc

1. FR-5=1.0 x 0.75 x 0.062 in

2. Pulse Test:Pulse Width=300 us, Duty Cycle \leq 2.0%

ELECTRICAL CHARACTERISTICS ($T_A=25^\circ\text{C}$ unless otherwise noted) (Continued)

Characteristics	Symbol	Min	Max	Unit
-----------------	--------	-----	-----	------

DC CHARACTERISTICS⁽¹⁾

DC Current Gain ($I_C = -0.1 \text{ mA}$, $V_{CE} = -10 \text{ Vdc}$)	h_{FE}	75	-	
($I_C = -1.0 \text{ mA}$, $V_{CE} = -10 \text{ Vdc}$)		100	-	
($I_C = -10 \text{ mA}$, $V_{CE} = -10 \text{ Vdc}$)		100	-	
($I_C = -150 \text{ mA}$, $V_{CE} = -10 \text{ Vdc}$)		100	300	
($I_C = -500 \text{ mA}$, $V_{CE} = -10 \text{ Vdc}$)		50	-	
Collector-Emitter Saturation Voltage ⁽³⁾ ($I_C = -150 \text{ mA}$, $I_B = -15 \text{ mA}$) ($I_C = -500 \text{ mA}$, $I_B = -50 \text{ mA}$)	$V_{CE(sat)}$	-	-0.4 -1.6	Vdc
Base-Emitter Saturation Voltage ⁽³⁾ ($I_C = -150 \text{ mA}$, $I_B = -15 \text{ mA}$) ($I_C = -500 \text{ mA}$, $I_B = -50 \text{ mA}$)	$V_{BE(sat)}$	-	-1.3 -2.6	Vdc

SMALL-SIGNAL CHARACTERISTICS

Current-Gain-Bandwidth Product (1) ($I_C = -50 \text{ mA}$, $V_{CE} = -20 \text{ Vdc}$, $f = 100 \text{ MHz}$)	f_T	200	-	MHz
Output Capacitance ($V_{CB} = -10 \text{ Vdc}$, $I_E = 0$, $f = 1.0 \text{ MHz}$)	C_{obo}	-	8.0	pF
Input Capacitance ($V_{EB} = -2.0 \text{ Vdc}$, $I_C = 0$, $f = 1.0 \text{ MHz}$)	C_{ibo}	-	30	pF

ELECTRICAL CHARACTERISTICS ($T_A=25^\circ\text{C}$ unless otherwise noted) (Continued)

Characteristics	Symbol	Min	Max	Unit
-----------------	--------	-----	-----	------

SWITCHING CHARACTERISTICS

Turn-On Time	$(V_{CC} = -30 \text{ Vdc}, I_C = -150 \text{ mA}, I_{B1} = -15 \text{ mA})$	t_{on}	-	45	ns
Delay Time		t_d	-	10	
Rise Time		t_r	-	40	
Turn-Off Time	$(V_{CC} = -60 \text{ Vdc}, I_C = -150 \text{ mA}, I_{B1} = I_{B2} = -15 \text{ mA})$	t_{off}	-	100	
Storage Time		t_s	-	80	
Fall Time		t_f	-	30	

TYPICAL CHARACTERISTICS

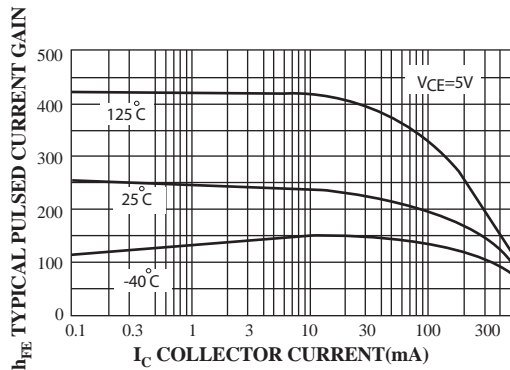

FIG.1 Typical Pulsed Current Gain vs Collector Current

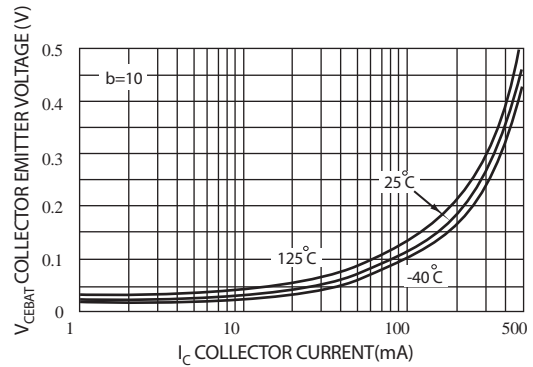

FIG.2 Collector-Emitter Saturation Voltage vs collector Current

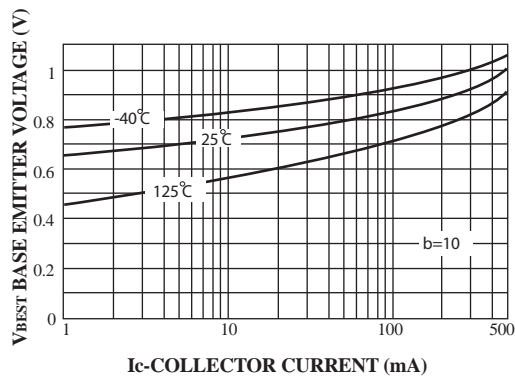

FIG.3 Base-Emitter Saturation Voltage vs Collector Current

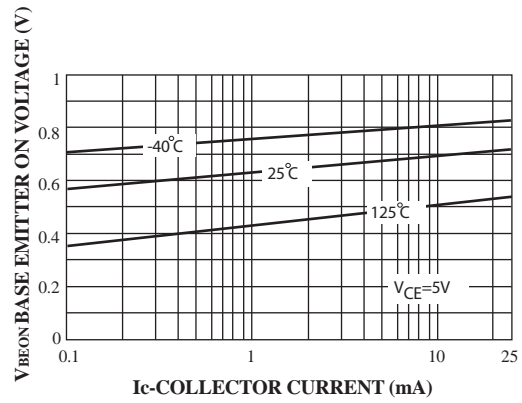

FIG.4 Base Emitter ON Voltage vs Collector Current

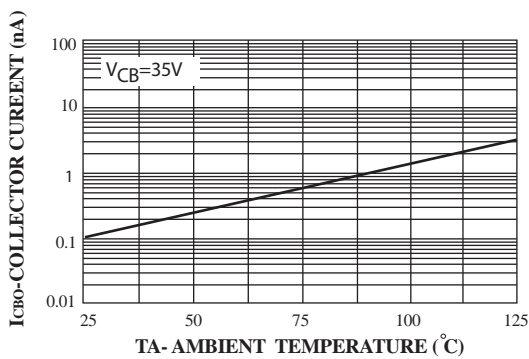

FIG.5 Collector-Cutoff Current vs. Ambient Temperature

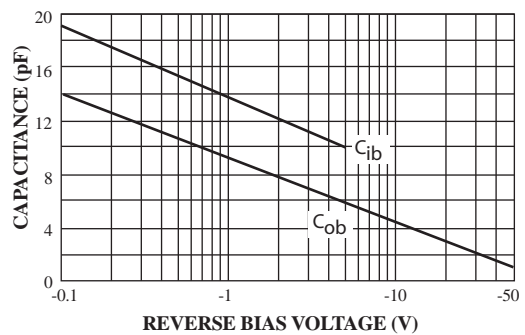
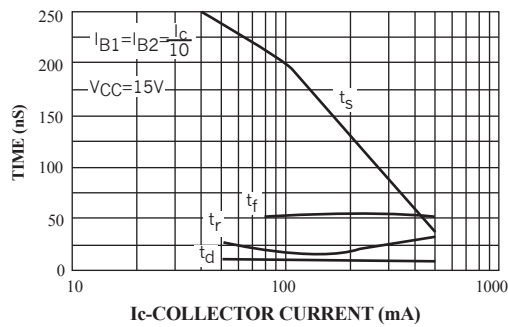

FIG.6 Input and Output Capacitance vs Reverse Bias Voltage

TYPICAL CHARACTERISTICS (CONTINUED)

Switching Times vs Collector Current



Turn On and Turn Off Times vs Collector Current

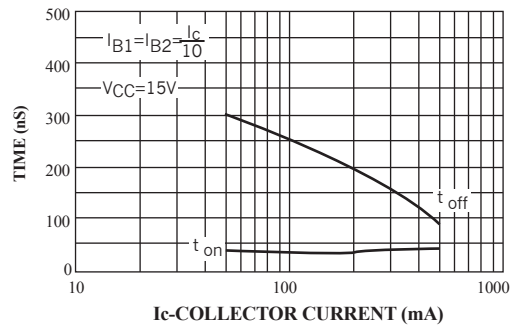

Rise Time vs Collector and Turn On Base Current

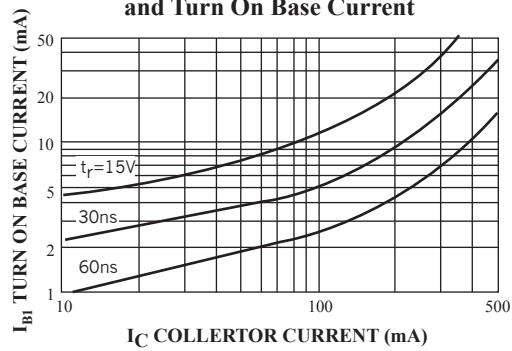

TEST CIRCUIT

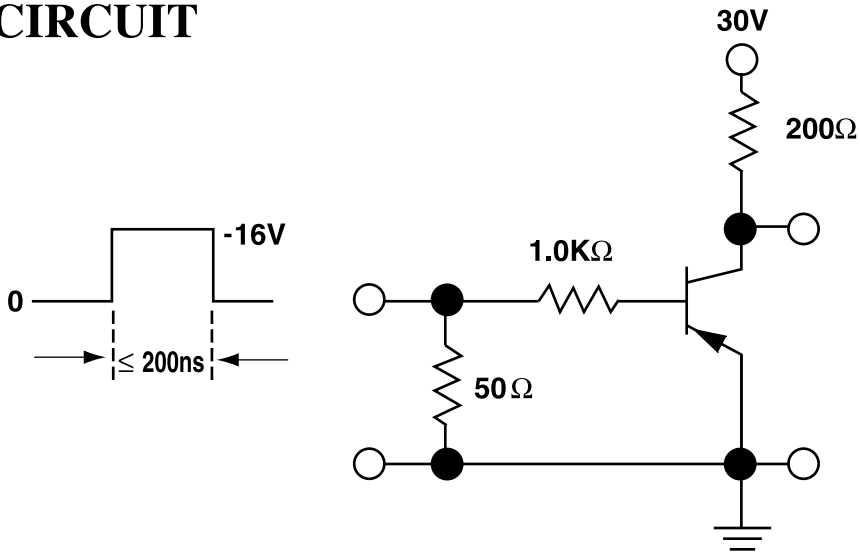

FIGURT 1: Saturated Turn-On Switching Time

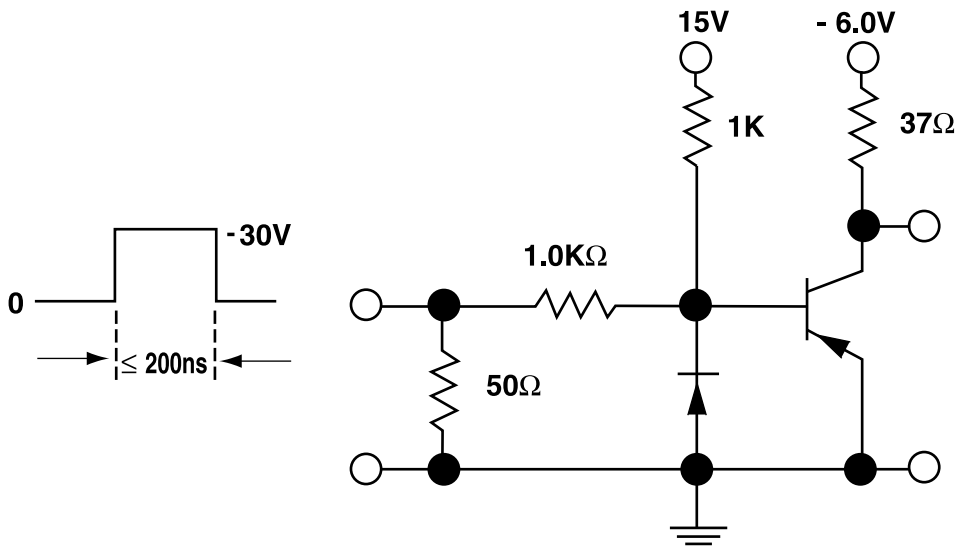

FIGURT 2: Saturated Turn-Off Switching Time

SOT-323 Package Outline Dimensions

Unit:mm

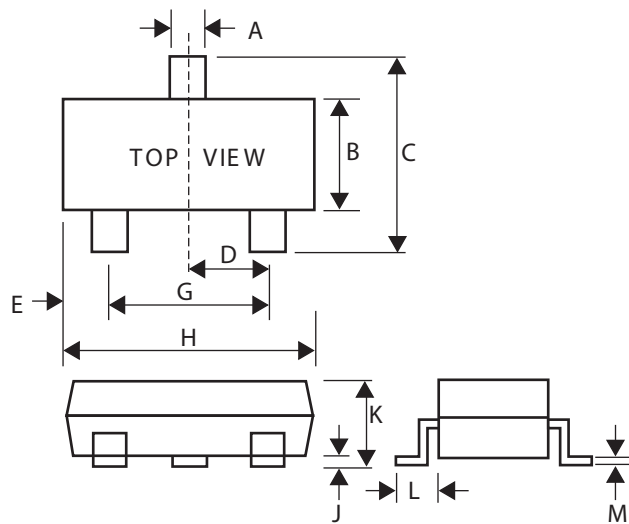

SOT-323		
Dim	Min	Max
A	0.30	0.40
B	1.15	1.35
C	2.00	2.40
D	-	0.65
E	0.30	0.40
G	1.20	1.40
H	1.80	2.20
J	0.00	0.10
K	0.80	1.00
L	0.42	0.53
M	0.10	0.25