

Features

- Glass Passivated Die Construction
- Low Forward Voltage Drop
- High Reliability
- High Surge Current Capability
- Design for Surface Mount Application
- Plastic Material – UL Flammability 94V-0
-  Recognized File # E157705

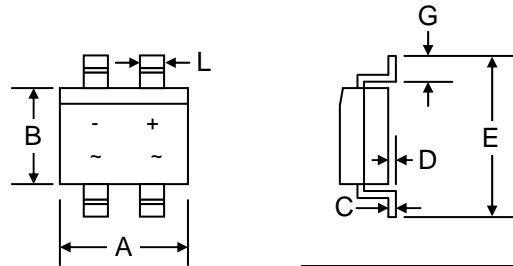

Mechanical Data

- Case: MB-S, Molded Plastic
- Terminals: Plated Leads Solderable per MIL-STD-202, Method 208
- Polarity: As Marked on Case
- Weight: 0.12 grams (approx.)
- Mounting Position: Any
- Marking: Type Number
- **Lead Free: For RoHS / Lead Free Version, Add "-LF" Suffix to Part Number, See Page 4**

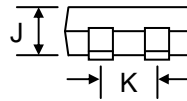

MB-S		
Dim	Min	Max
A	4.50	4.90
B	3.60	4.00
C	0.15	0.35
D	—	0.20
E	—	7.00
G	0.70	1.10
J	2.30	2.70
K	2.20	2.60
L	0.56	0.84
All Dimensions in mm		

Maximum Ratings and Electrical Characteristics @T_A=25°C unless otherwise specified

Single Phase, half wave, 60Hz, resistive or inductive load.
For capacitive load, derate current by 20%.

Characteristic	Symbol	B1S	B2S	B4S	B6S	B8S	B10S	Unit
Peak Repetitive Reverse Voltage	V _{RRM}							
Working Peak Reverse Voltage	V _{RWM}	100	200	400	600	800	1000	V
DC Blocking Voltage	V _R							
RMS Reverse Voltage	V _{R(RMS)}	70	140	280	420	560	700	V
Average Rectified Output Current (Note 1) @T _A = 40°C	I _O	0.8						A
Average Rectified Output Current (Note 2) @T _A = 40°C		0.5						
Non-Repetitive Peak Forward Surge Current 8.3ms Single Half Sine-Wave Superimposed on Rated Load (JEDEC Method)	I _{FSM}	35						A
Forward Voltage per diode @I _F = 0.4A	V _{FM}	1.0						V
@I _F = 0.8A		1.1						
Peak Reverse Current @T _A = 25°C	I _{RM}	5.0						μA
At Rated DC Blocking Voltage @T _A = 125°C		500						
Typical Junction Capacitance per diode (Note 3)	C _J	13						pF
Thermal Resistance Junction to Ambient (Note 2)	R _{JA}	134						°C/W
Thermal Resistance Junction to Ambient (Note 1)	R _{JA}	76						
Thermal Resistance Junction to Lead (Note 2)	R _{JL}	20						
Operating and Storage Temperature Range	T _J , T _{STG}	-55 to +150						°C

- Note: 1. Mounted on aluminum substrate PCB with 1.3 x 1.3mm pad areas.
2. Mounted on glass epoxy PCB with 1.3 x 1.3mm pad areas.
3. Measured at 1.0 MHz and applied reverse voltage of 4.0V D.C.

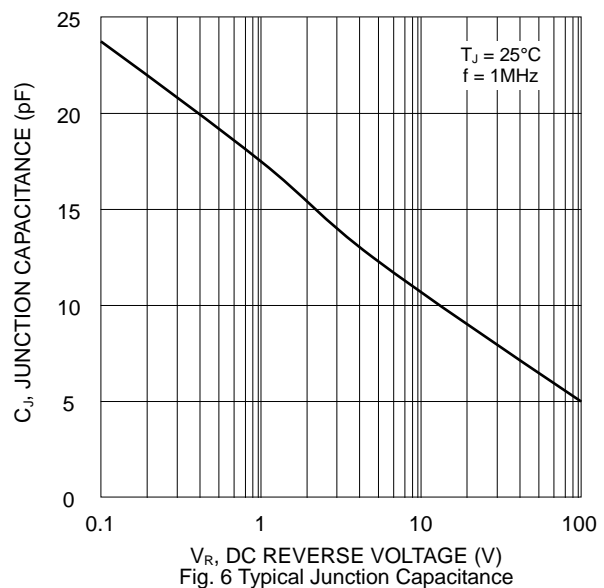
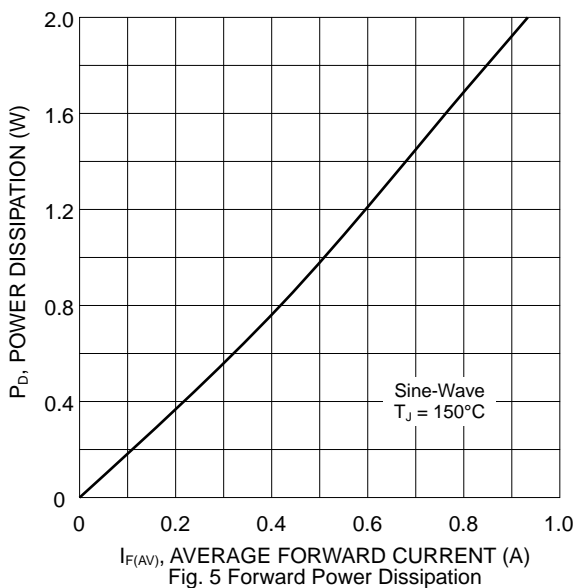
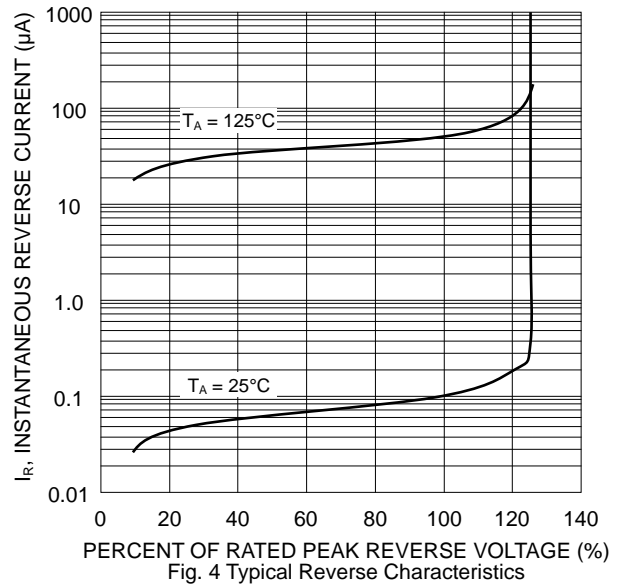
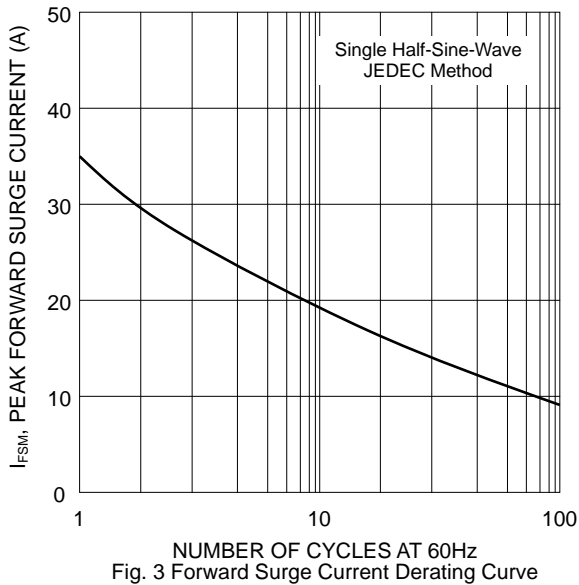
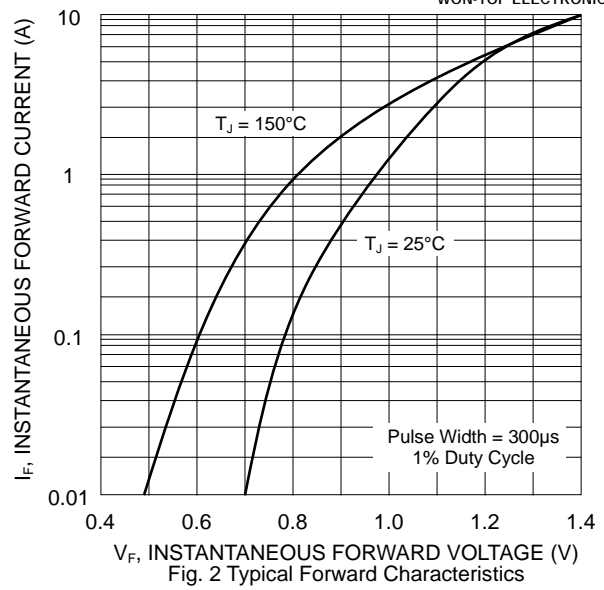
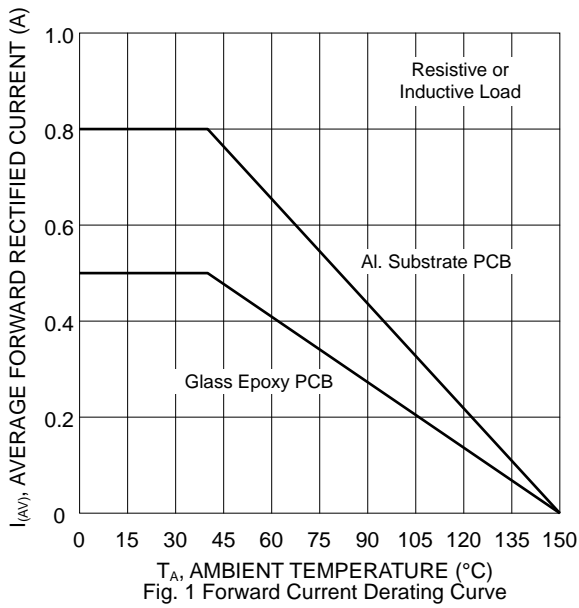

MARKING INFORMATION

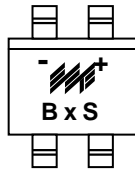

BxS = Device Number
 x = 1, 2, 4, 6, 8 or 10
 Polarity = As Marked on Body

RECOMMENDED FOOTPRINT

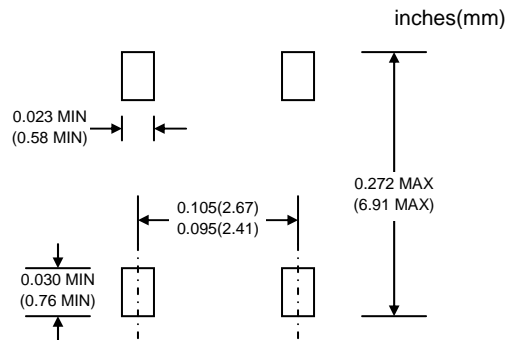

PACKAGING INFORMATION

TAPE & REEL

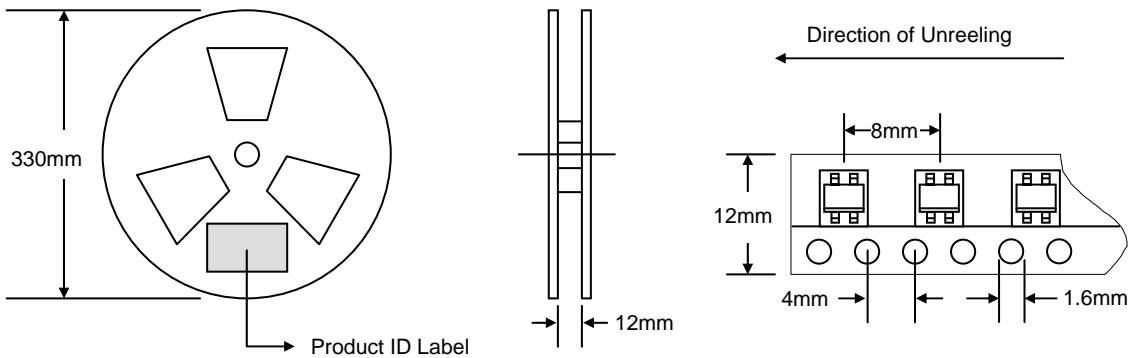

Reel Diameter (mm)	Quantity (PCS)	Inner Box Size L x W x H (mm)	Quantity (PCS)	Carton Size L x W x H (mm)	Quantity (PCS)	Approx. Gross Weight (KG)
330	3,000	340 x 337 x 45	6,000	370 x 370 x 420	48,000	15.0

Note: 1. Paper reel, white or gray color.
 2. Components are packed in accordance with EIA standard 481-1 and 481-2.

ORDERING INFORMATION

Product No.	Package Type	Shipping Quantity
B1S-T3	MB-S	3000/Tape & Reel
B2S-T3	MB-S	3000/Tape & Reel
B4S-T3	MB-S	3000/Tape & Reel
B6S-T3	MB-S	3000/Tape & Reel
B8S-T3	MB-S	3000/Tape & Reel
B10S-T3	MB-S	3000/Tape & Reel

1. Shipping quantity given is for minimum packing quantity only. For minimum order quantity, please consult the Sales Department.
2. **To order RoHS / Lead Free version (with Lead Free finish), add "-LF" suffix to part number above. For example, B1S-T3-LF.**

WON-TOP ELECTRONICS and  are registered trademarks of Won-Top Electronics Co., Ltd (WTE). WTE has checked all information carefully and believes it to be correct and accurate. However, WTE cannot assume any responsibility for inaccuracies. Furthermore, this information does not give the purchaser of semiconductor devices any license under patent rights to manufacturer. WTE reserves the right to change any or all information herein without further notice.

WARNING: DO NOT USE IN LIFE SUPPORT EQUIPMENT. WTE power semiconductor products are not authorized for use as critical components in life support devices or systems without the express written approval.

Won-Top Electronics Co., Ltd.
No. 44 Yu Kang North 3rd Road,
Chine Chen Dist., Kaohsiung 806, Taiwan
Phone: 886-7-822-5408 or 886-7-822-5410
Fax: 886-7-822-5417
Email: sales@wontop.com
Internet: http://www.wontop.com

We power your everyday.