

DATA SHEET

BLF248 VHF push-pull power MOS transistor

Product specification

September 1992

VHF push-pull power MOS transistor

BLF248

FEATURES

- High power gain
- Easy power control
- Good thermal stability
- Gold metallization ensures excellent reliability.

DESCRIPTION

Dual push-pull silicon N-channel enhancement mode vertical D-MOS transistor, designed for large signal amplifier applications in the VHF frequency range.

The transistor is encapsulated in a 4-lead SOT262 A1 balanced flange envelope, with two ceramic caps. The mounting flange provides the common source connection for the transistors.

PIN CONFIGURATION

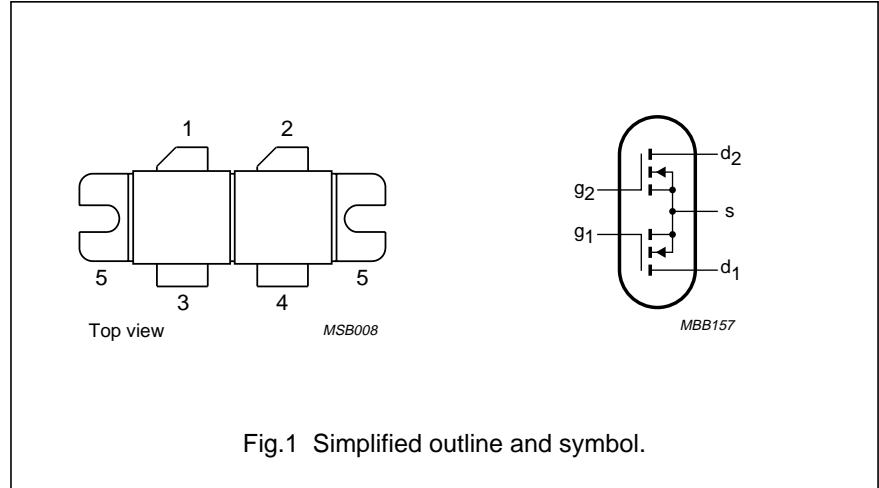

Fig.1 Simplified outline and symbol.

CAUTION

The device is supplied in an antistatic package. The gate-source input must be protected against static charge during transport and handling.

PINNING - SOT262 A1

PIN	DESCRIPTION
1	drain 1
2	drain 2
3	gate 1
4	gate 2
5	source

WARNING

Product and environmental safety - toxic materials

This product contains beryllium oxide. The product is entirely safe provided that the BeO discs are not damaged. All persons who handle, use or dispose of this product should be aware of its nature and of the necessary safety precautions. After use, dispose of as chemical or special waste according to the regulations applying at the location of the user. It must never be thrown out with the general or domestic waste.

QUICK REFERENCE DATA

RF performance at $T_h = 25\text{ }^\circ\text{C}$ in a push-pull common source test circuit.

MODE OF OPERATION	f (MHz)	V _{DS} (V)	P _L (W)	G _P (dB)	η_D (%)
class-AB	225	28	300	> 10	> 55
	175	28	300	typ. 13	typ. 67

VHF push-pull power MOS transistor

BLF248

LIMITING VALUES

In accordance with the Absolute Maximum System (IEC 134).

Per transistor section unless otherwise specified.

SYMBOL	PARAMETER	CONDITIONS	MIN.	MAX.	UNIT
V_{DS}	drain-source voltage		–	65	V
$\pm V_{GS}$	gate-source voltage		–	20	V
I_D	DC drain current		–	25	A
P_{tot}	total power dissipation	up to $T_{mb} = 25\text{ }^\circ\text{C}$ total device; both sections equally loaded	–	500	W
T_{stg}	storage temperature		–65	150	$^\circ\text{C}$

THERMAL RESISTANCE

SYMBOL	PARAMETER	CONDITIONS	THERMAL RESISTANCE
$R_{th\ j-mb}$	thermal resistance from junction to mounting base	total device; both sections equally loaded.	0.35 K/W
$R_{th\ mb-h}$	thermal resistance from mounting base to heatsink	total device; both sections equally loaded.	0.15 K/W

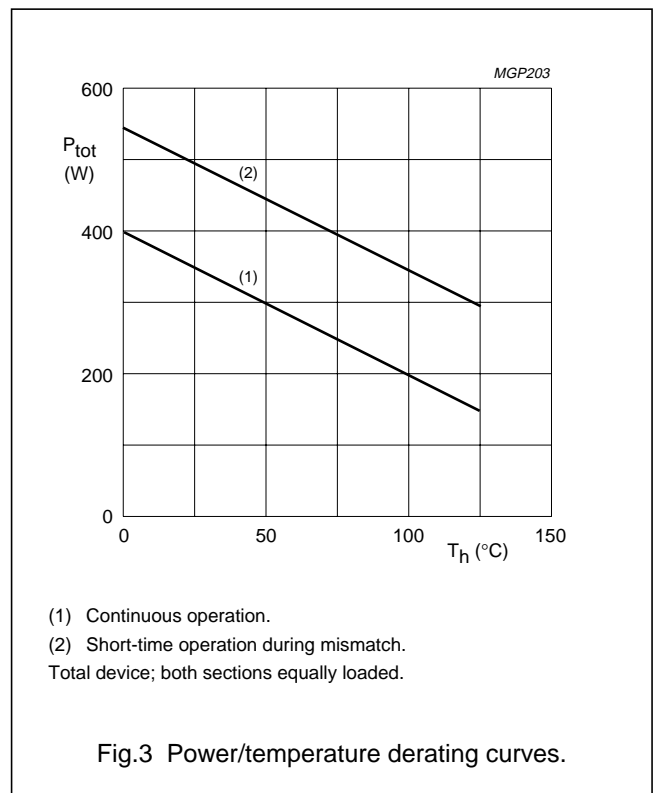
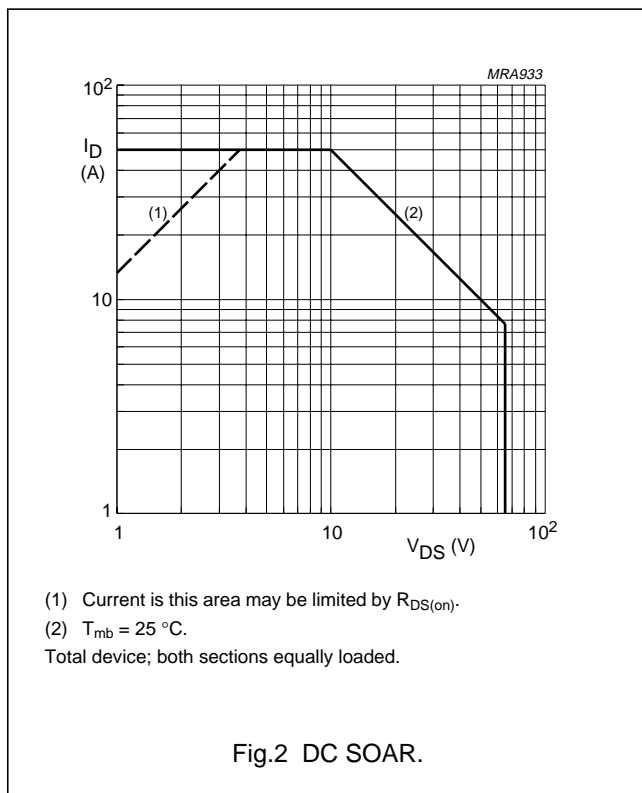

VHF push-pull power MOS transistor

BLF248

CHARACTERISTICS (per section)

$T_j = 25\text{ }^\circ\text{C}$ unless otherwise specified.

SYMBOL	PARAMETER	CONDITIONS	MIN.	TYP.	MAX.	UNIT
$V_{(BR)DSS}$	drain-source breakdown voltage	$V_{GS} = 0; I_D = 100\text{ mA}$	65	–	–	V
I_{DSS}	drain-source leakage current	$V_{GS} = 0; V_{DS} = 28\text{ V}$	–	–	5	mA
I_{GSS}	gate-source leakage current	$\pm V_{GS} = 20\text{ V}; V_{DS} = 0$	–	–	1	μA
$V_{GS(th)}$	gate-source threshold voltage	$I_D = 100\text{ mA}; V_{DS} = 10\text{ V}$	2	–	4.5	V
ΔV_{GS}	gate-source voltage difference of both transistor sections	$I_D = 100\text{ mA}; V_{DS} = 10\text{ V}$	–	–	100	mV
g_{fs}	forward transconductance	$I_D = 8\text{ A}; V_{DS} = 10\text{ V}$	5	7.5	–	S
g_{fs1}/g_{fs2}	forward transconductance ratio of both transistor sections	$I_D = 8\text{ A}; V_{DS} = 10\text{ V}$	0.9	–	1.1	
$R_{DS(on)}$	drain-source on-state resistance	$I_D = 8\text{ A}; V_{GS} = 10\text{ V}$	–	0.1	0.15	Ω
I_{DSX}	on-state drain current	$V_{GS} = 10\text{ V}; V_{DS} = 10\text{ V}$	–	37	–	A
C_{is}	input capacitance	$V_{GS} = 0; V_{DS} = 28\text{ V}; f = 1\text{ MHz}$	–	500	–	pF
C_{os}	output capacitance	$V_{GS} = 0; V_{DS} = 28\text{ V}; f = 1\text{ MHz}$	–	360	–	pF
C_{rs}	feedback capacitance	$V_{GS} = 0; V_{DS} = 28\text{ V}; f = 1\text{ MHz}$	–	46	–	pF

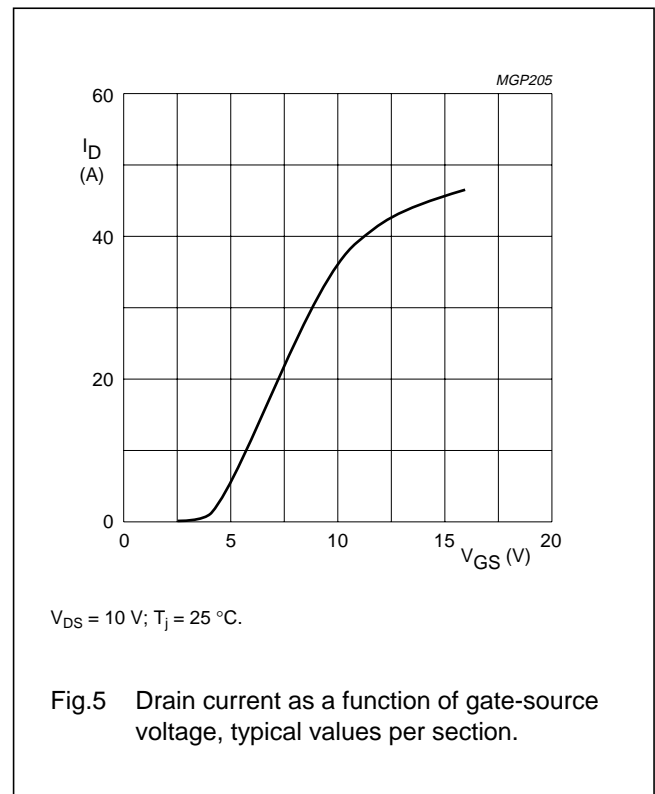
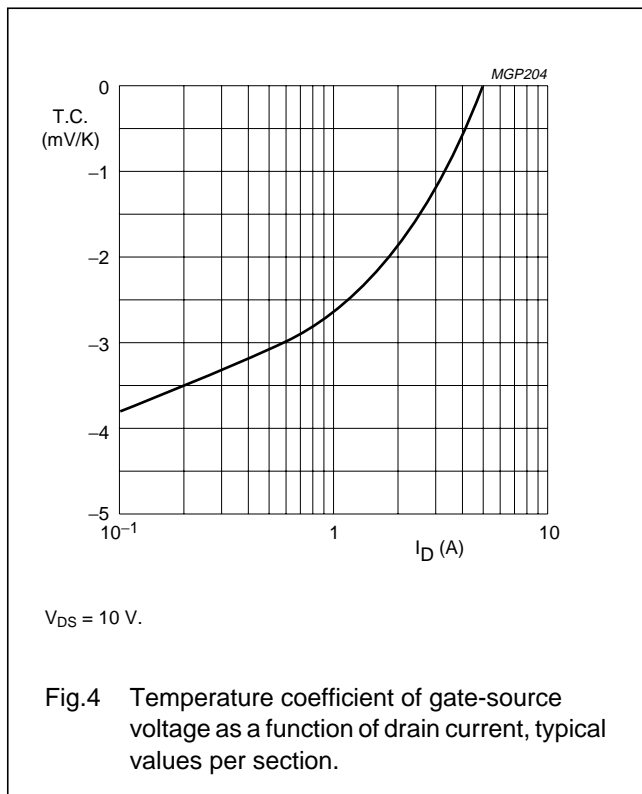

VHF push-pull power MOS transistor

BLF248

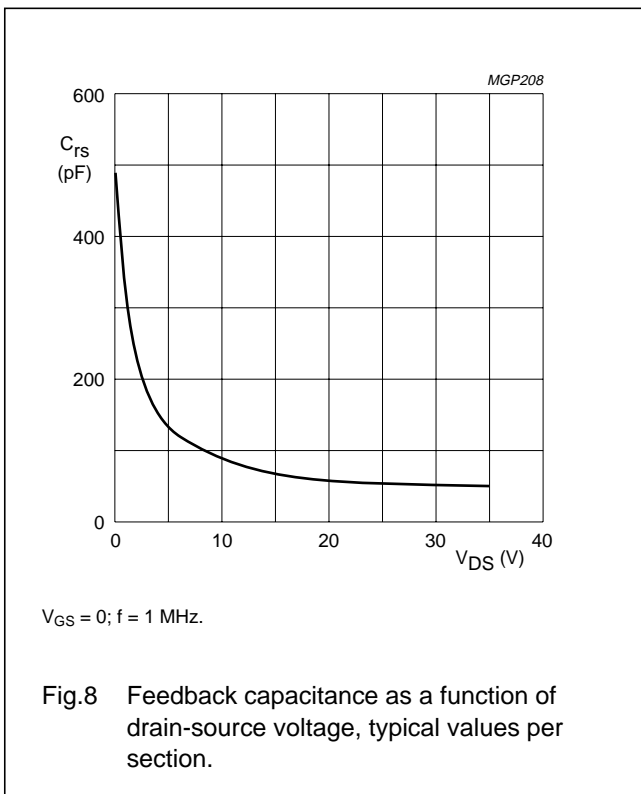
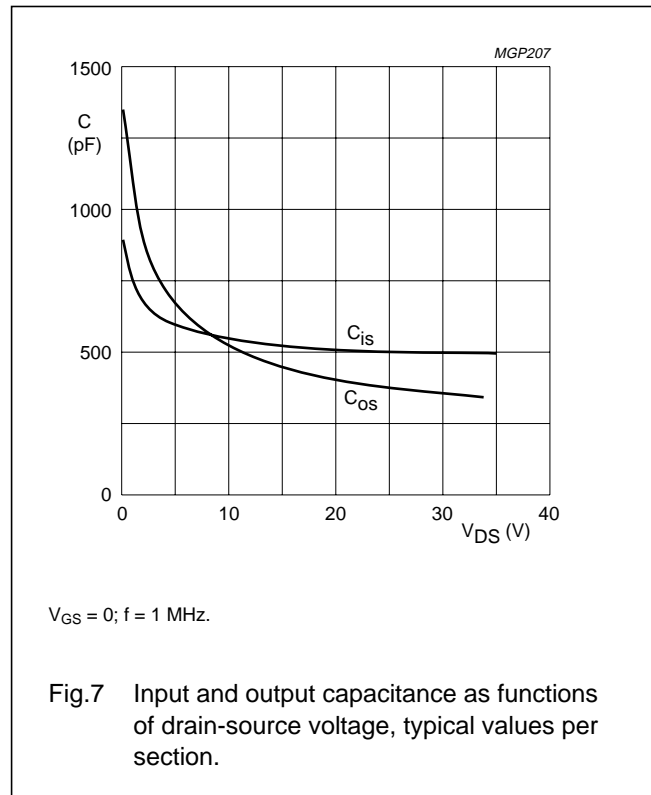
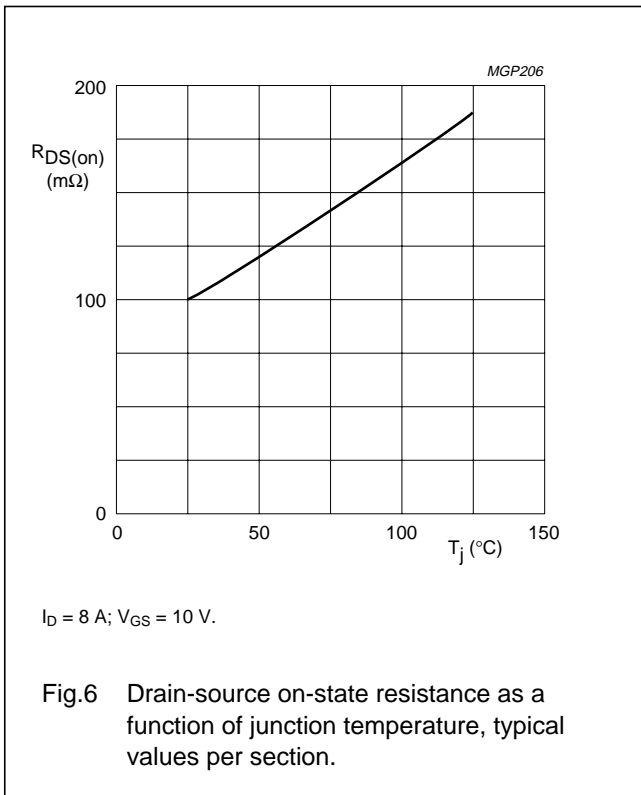

VHF push-pull power MOS transistor

BLF248

APPLICATION INFORMATION FOR CLASS-AB OPERATION

$T_h = 25\text{ }^\circ\text{C}$; $R_{th\text{ mb-h}} = 0.15\text{ K/W}$, unless otherwise specified.

RF performance in a linear amplifier in a common source class-AB circuit.

$R_{GS} = 536\text{ }\Omega$ per section; optimum load impedance per section = $0.79 - j0.11\text{ }\Omega$.

MODE OF OPERATION	f (MHz)	V _{DS} (V)	P _L (W)	G _P (dB)	η_D (%)
class-AB	225	28	300	> 10 typ. 11.5	> 55 typ. 65
	175	28	300	typ. 13	typ. 67

Ruggedness in class-AB operation

The BLF248 is capable of withstanding a load mismatch corresponding to VSWR = 50 through all phases under the following conditions:

$V_{DS} = 28\text{ V}$; $f = 225\text{ MHz}$ at rated output power.

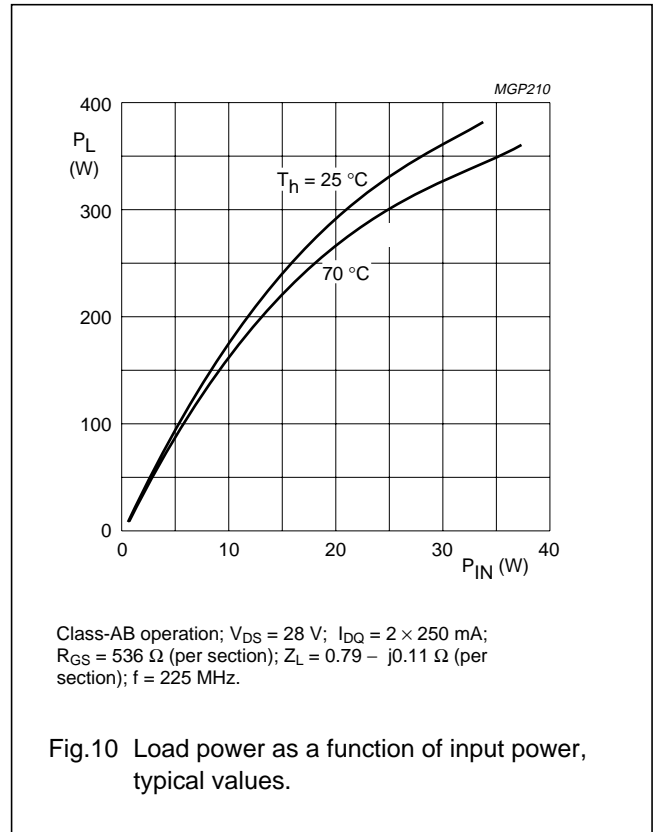
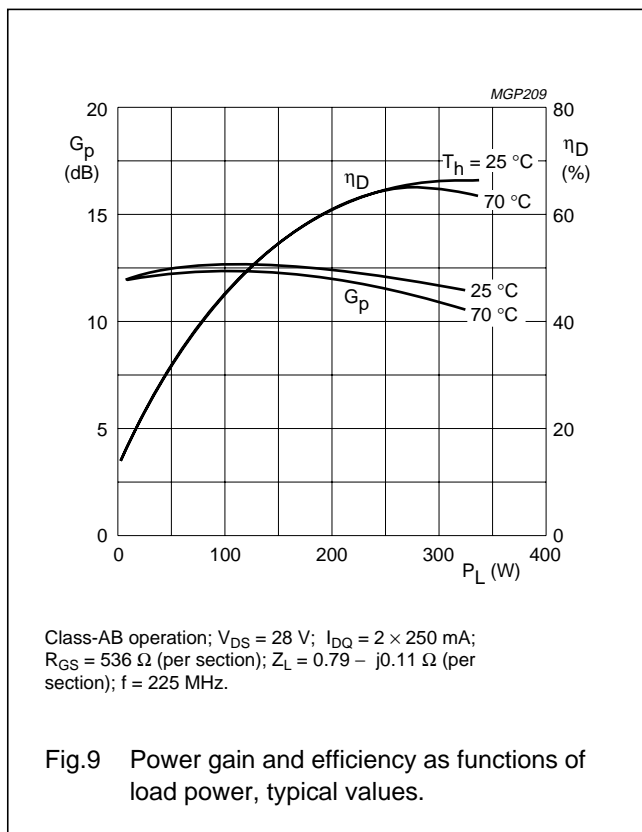

VHF push-pull power MOS transistor

BLF248

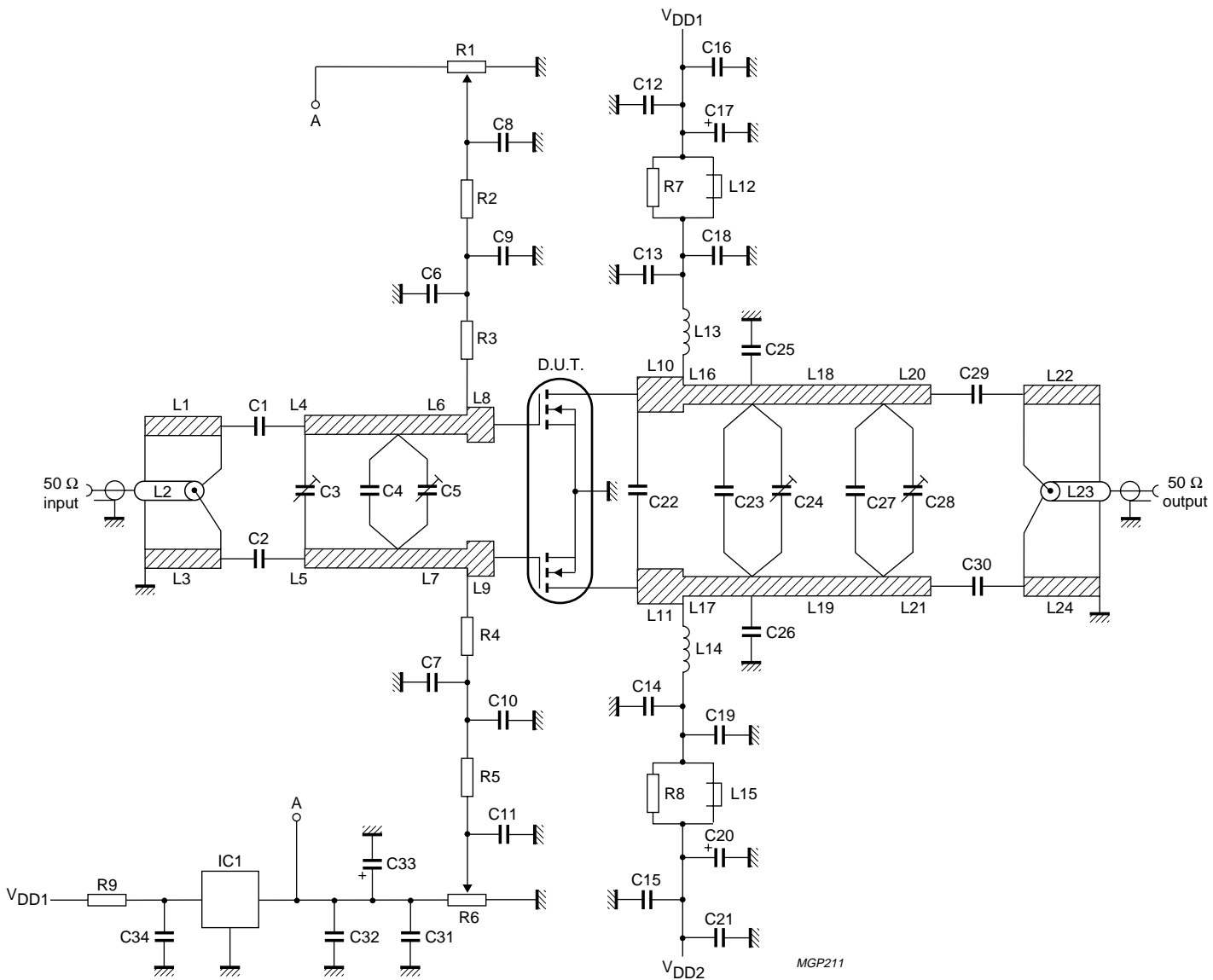

Fig.11 Test circuit for class-AB operation.

VHF push-pull power MOS transistor

BLF248

List of components (class-AB test circuit)

COMPONENT	DESCRIPTION	VALUE	DIMENSIONS	CATALOGUE NO.
C1, C2	multilayer ceramic chip capacitor (note 1)	2 × 56 pF + 18 pF in parallel, 500 V		
C3	film dielectric trimmer	2 to 9 pF		2222 809 09005
C4	multilayer ceramic chip capacitor (note 1)	47 pF, 500 V		
C5	film dielectric trimmer	5 to 60 pF		2222 809 08003
C6, C7, C9, C10, C12, C15, C31, C34	multilayer ceramic chip capacitor (note 1)	1 nF, 500 V		
C8, C11, C16, C21, C32	multilayer ceramic chip capacitor	100 nF, 50 V		2222 852 47104
C13, C14, C18, C19	multilayer ceramic chip capacitor (note 1)	510 pF, 500 V		
C17, C20, C33	electrolytic capacitor	10 µF, 63 V		
C22	multilayer ceramic chip capacitor (note 1)	82 pF, 500 V		
C23	multilayer ceramic chip capacitor (note 1)	10 pF + 30 pF in parallel, 500 V		
C24, C28	film dielectric trimmer	2 to 18 pF		2222 809 09006
C25, C26	multilayer ceramic chip capacitor (note 1)	39 pF + 47 pF in parallel, 500 V		
C27	multilayer ceramic chip capacitor (note 1)	18 pF, 500 V		
C29, C30	multilayer ceramic chip capacitor (note 1)	3 × 100 pF in parallel, 500 V		
L1, L3, L22, L24	stripline (note 2)	50 Ω	4.8 × 80 mm	
L2, L23	semi-rigid cable (note 3)	50 Ω	ext. dia. 3.6 mm ext. conductor length 80 mm	
L4, L5	stripline (note 2)	43 Ω	6 × 32.5 mm	
L6, L7, L10, L11	stripline (note 2)	43 Ω	6 × 10.5 mm	
L8, L9	stripline (note 2)	43 Ω	6 × 3 mm	
L12, L15	grade 3B Ferroxcube wide-band HF choke	2 in parallel		4312 020 36642
L13, L14	2 turns enamelled 1.6 mm copper wire	25 nH	int. dia. 5 mm leads 2 × 7 mm space 2.5 mm	
L16, L17	stripline (notes 2 and 4)	43 Ω	6 × 3 mm	
L18, L19	stripline (notes 2 and 4)	43 Ω	6 × 35 mm	
L20, L21	stripline (notes 2 and 4)	43 Ω	6 × 9 mm	
R1, R6	10 turns potentiometer	50 kΩ		
R2, R5	0.4 W metal film resistor	1 kΩ		

VHF push-pull power MOS transistor

BLF248

COMPONENT	DESCRIPTION	VALUE	DIMENSIONS	CATALOGUE NO.
R3, R4	0.4 W metal film resistor	536 Ω		
R7, R8	1 W metal film resistor	10 $\Omega \pm 5\%$		
R9	1 W metal film resistor	3.16 k Ω		
IC1	78L05 voltage regulator			

Notes

1. American Technical Ceramics (ATC) capacitor, type 100B or other capacitor of the same quality.
2. L1, L3 - L11, L16 - L22 and L24 are micro-striplines on a double copper-clad printed circuit board, with glass microfibre PTFE dielectric ($\epsilon_r = 2.2$), thickness $\frac{1}{16}$ inch, thickness of copper sheet $2 \times 35 \mu\text{m}$.
3. L2 and L23 are soldered on striplines L1 and L24 respectively.
4. A copper strap, thickness 0.8 mm, is soldered on striplines L16 - L21.

VHF push-pull power MOS transistor

BLF248

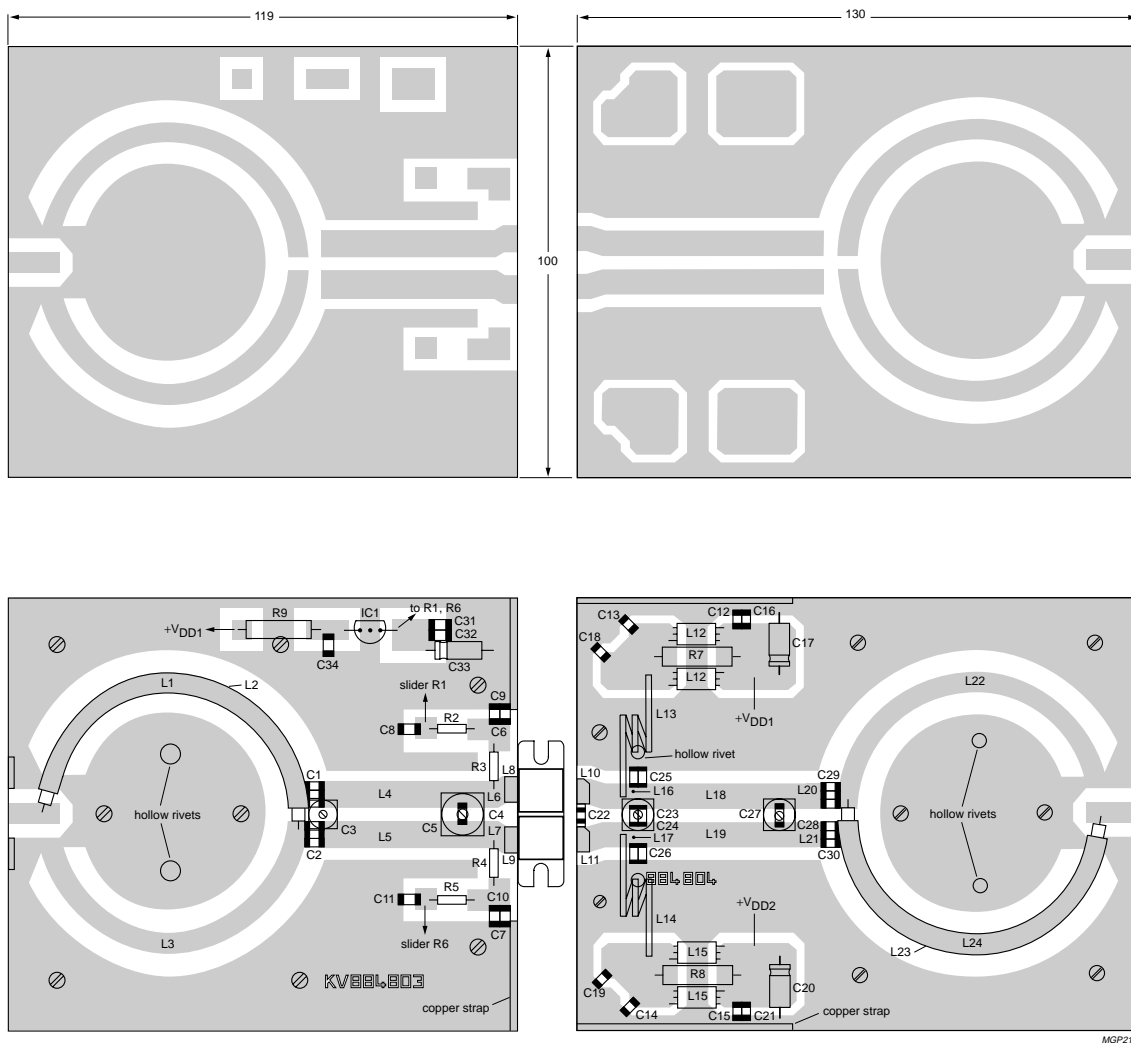

The circuit and components are situated on one side of the printed circuit board, the other side being fully metallized, to serve as a ground plane. Earth connections are made by means of copper straps and hollow rivets. Dimensions in mm.

Fig.12 Component layout for 225 MHz class-AB test circuit.

VHF push-pull power MOS transistor

BLF248

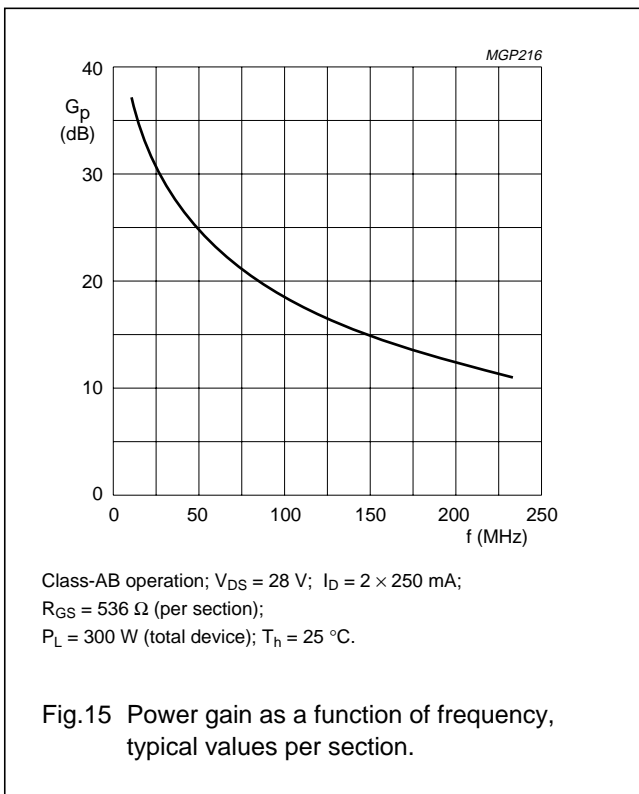
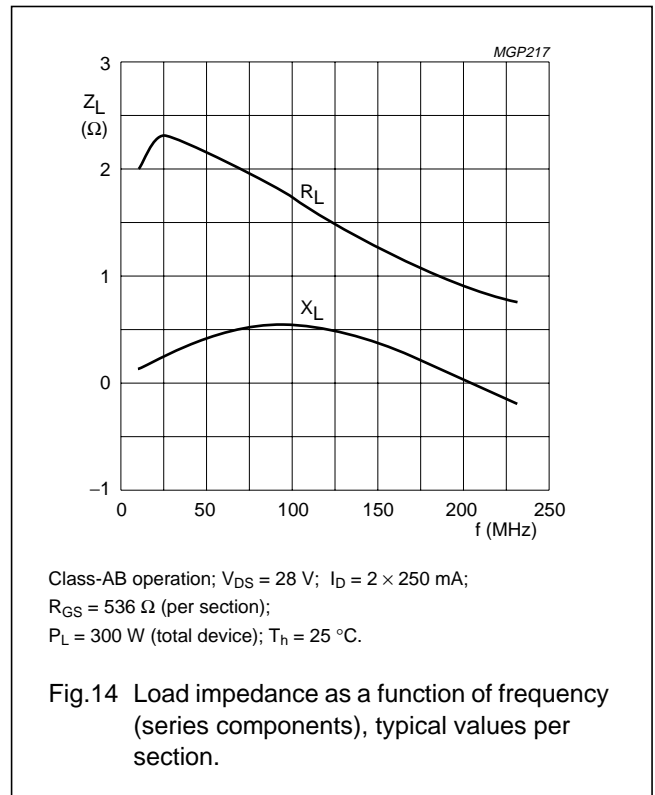
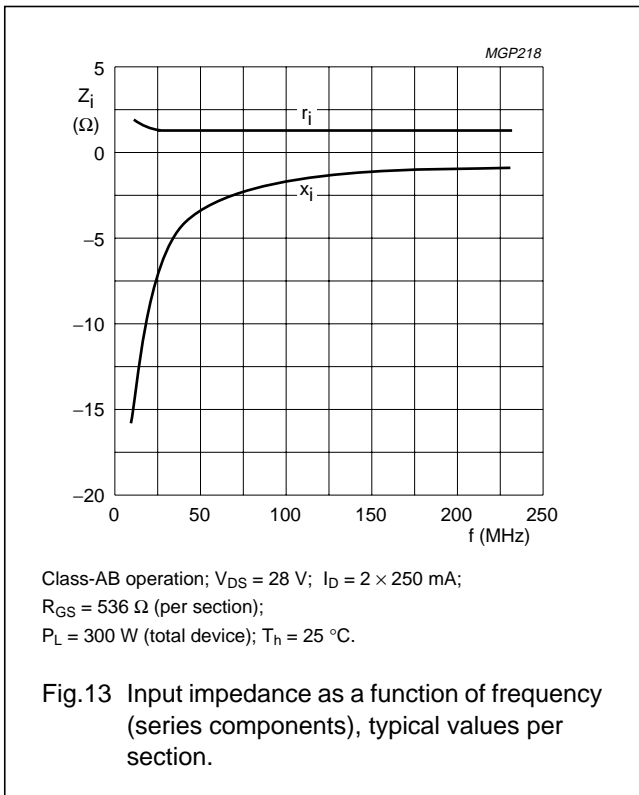

VHF push-pull power MOS transistor

BLF248

PACKAGE OUTLINE

Flanged double-ended ceramic package; 2 mounting holes; 4 leads

SOT262A1

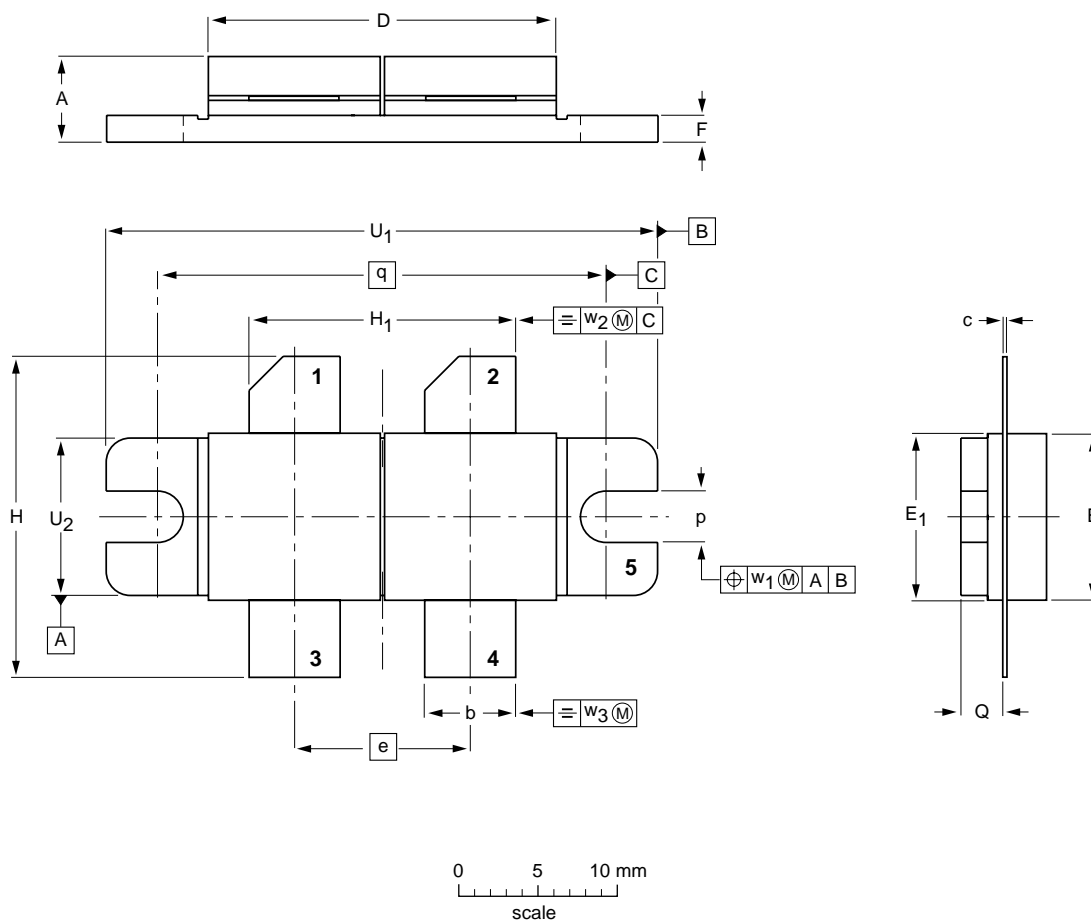

DIMENSIONS (millimetre dimensions are derived from the original inch dimensions)

UNIT	A	b	c	D	e	E	E ₁	F	H	H ₁	p	Q	q	U ₁	U ₂	w ₁	w ₂	w ₃
mm	5.77 5.00	5.85 5.58	0.16 0.10	21.98 21.71	11.05	10.27 10.05	10.29 10.03	1.78 1.52	20.58 20.06	17.02 16.51	3.28 3.02	2.85 2.59	27.94	34.17 33.90	9.91 9.65	0.51	1.02	0.25
inches	0.227 0.197	0.230 0.220	0.006 0.004	0.865 0.855	0.435	0.404 0.396	0.405 0.395	0.070 0.060	0.81 0.79	0.67 0.65	0.129 0.119	0.112 0.102	1.100	1.345 1.335	0.390 0.380	0.02	0.04	0.01

OUTLINE VERSION	REFERENCES				EUROPEAN PROJECTION	ISSUE DATE
	IEC	JEDEC	EIAJ			
SOT262A1						97-06-28

VHF push-pull power MOS transistor

BLF248

DEFINITIONS

Data Sheet Status	
Objective specification	This data sheet contains target or goal specifications for product development.
Preliminary specification	This data sheet contains preliminary data; supplementary data may be published later.
Product specification	This data sheet contains final product specifications.
Limiting values	
Limiting values given are in accordance with the Absolute Maximum Rating System (IEC 134). Stress above one or more of the limiting values may cause permanent damage to the device. These are stress ratings only and operation of the device at these or at any other conditions above those given in the Characteristics sections of the specification is not implied. Exposure to limiting values for extended periods may affect device reliability.	
Application information	
Where application information is given, it is advisory and does not form part of the specification.	

LIFE SUPPORT APPLICATIONS

These products are not designed for use in life support appliances, devices, or systems where malfunction of these products can reasonably be expected to result in personal injury. Philips customers using or selling these products for use in such applications do so at their own risk and agree to fully indemnify Philips for any damages resulting from such improper use or sale.