

## Silicon Switching Diode

BAR 99

- For high-speed switching

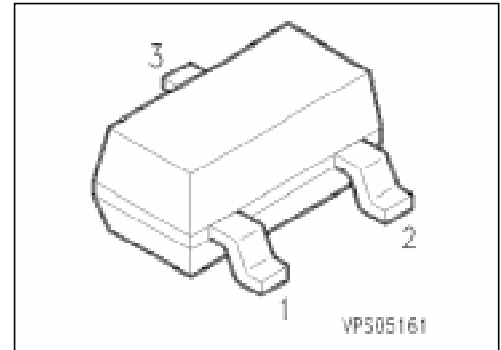

Type	Marking	Ordering Code (tape and reel)	Pin Configuration	Package <sup>1)</sup>
BAR 99	JGs	Q62702-A388		SOT-23

### Maximum Ratings

Parameter	Symbol	Values	Unit
Reverse voltage	$V_R$	70	V
Peak reverse voltage	$V_{RM}$	70	
Forward current	$I_F$	250	mA
Surge forward current, $t = 1 \mu s$	$I_{FS}$	4.5	A
Total power dissipation, $T_s = 54 \text{ }^\circ\text{C}$	$P_{tot}$	370	mW
Junction temperature	$T_j$	150	$^\circ\text{C}$
Storage temperature range	$T_{stg}$	- 65 ... + 150	

### Thermal Resistance

Junction - ambient <sup>2)</sup>	$R_{th JA}$	$\leq 330$	K/W
Junction - soldering point	$R_{th JS}$	$\leq 260$	

<sup>1)</sup> For detailed information see chapter Package Outlines.

<sup>2)</sup> Package mounted on epoxy pcb 40 mm × 40 mm × 1.5 mm/6 cm<sup>2</sup> Cu.

## Electrical Characteristics

at  $T_A = 25\text{ }^\circ\text{C}$ , unless otherwise specified.

Parameter	Symbol	Values			Unit
		min.	typ.	max.	

### DC characteristics

Breakdown voltage $I_{(BR)} = 100\text{ }\mu\text{A}$	$V_{(BR)}$	70	–	–	V
Forward voltage $I_F = 1\text{ mA}$ $I_F = 10\text{ mA}$ $I_F = 50\text{ mA}$ $I_F = 150\text{ mA}$	$V_F$	–	–	715 855 1000 1250	mV
Reverse current $V_R = 70\text{ V}$ $V_R = 25\text{ V}, T_A = 150\text{ }^\circ\text{C}$ $V_R = 70\text{ V}, T_A = 150\text{ }^\circ\text{C}$	$I_R$	–	–	2.5 30 50	$\mu\text{A}$

### AC characteristics

Diode capacitance $V_R = 0\text{ V}, f = 1\text{ MHz}$	$C_D$	–	–	1.5	pF
Reverse recovery time $I_F = 10\text{ mA}, I_R = 10\text{ mA}, R_L = 100\text{ }\Omega$ measured at $I_R = 1\text{ mA}$	$t_{rr}$	–	–	6	ns

### Test circuit for reverse recovery time

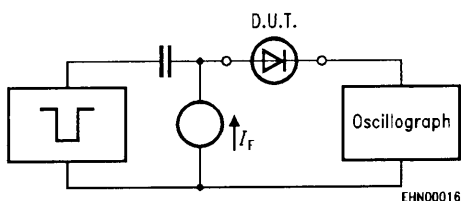

Pulse generator:  $t_p = 100\text{ ns}, D = 0.05$   
 $t_r = 0.6\text{ ns}, R_j = 50\text{ }\Omega$

Oscilloscope:  $R = 50\text{ }\Omega$   
 $t_r = 0.35\text{ ns}$   
 $C \leq 1\text{ pF}$

**Forward current  $I_F = f(T_A^*; T_S)$**

\* Package mounted on epoxy

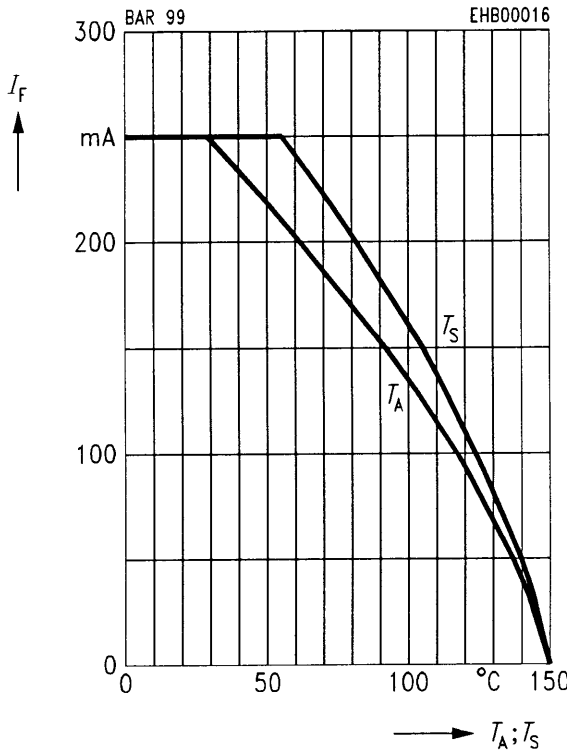

**Reverse current  $I_R = f(T_A)$**

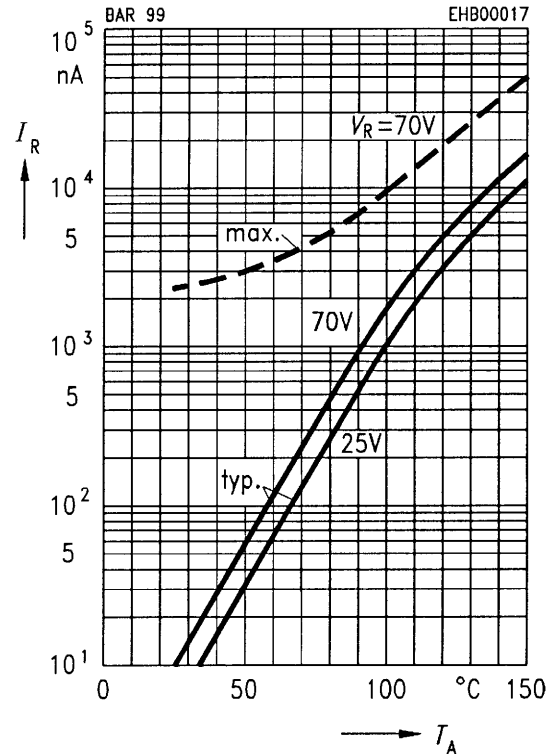

**Forward current  $I_F = f(V_F)$**

$T_A = 25\text{ °C}$

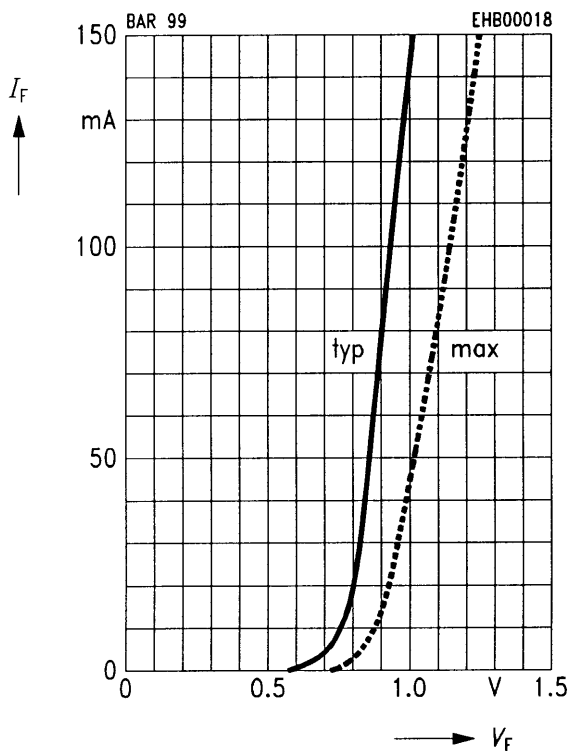

**Peak forward current  $I_{FM} = f(t)$**

$T_A = 25\text{ °C}$

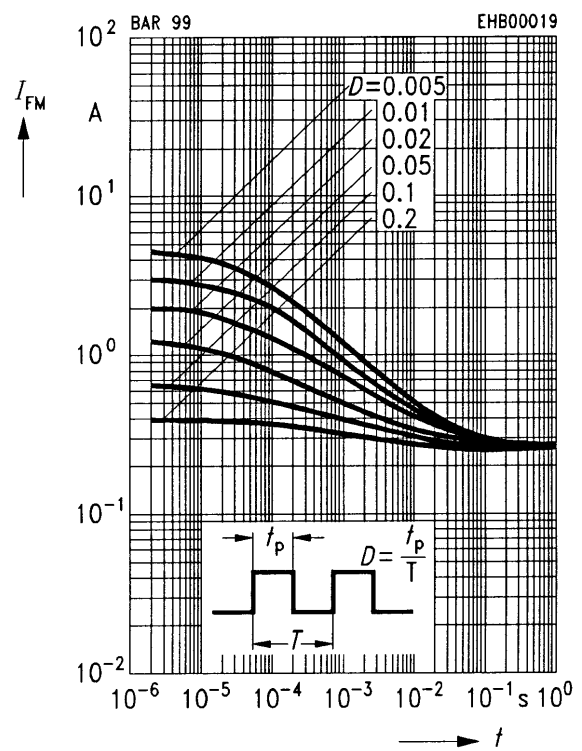

## Forward voltage $V_F = f(T_A)$

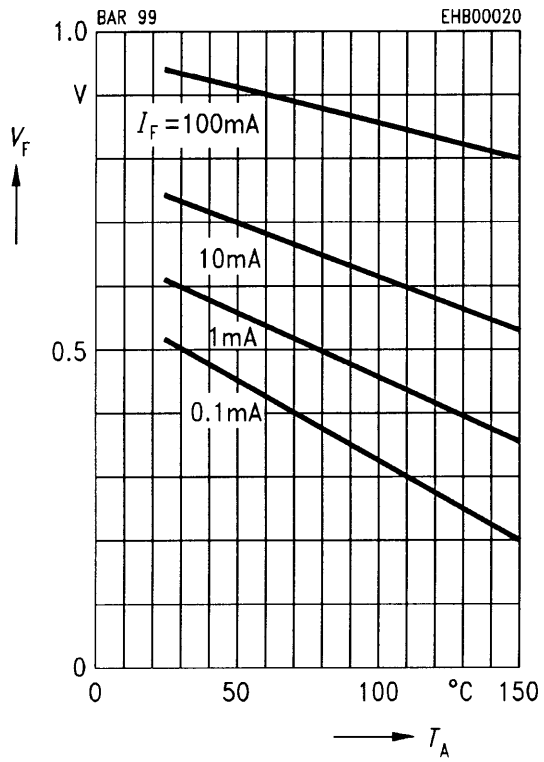

This datasheet has been download from:

[www.datasheetcatalog.com](http://www.datasheetcatalog.com)

Datasheets for electronics components.