



Frontier Electronics Corp.

667 E. COCHRAN STREET, SIMI VALLEY, CA 93065

TEL: (805) 522-9998 FAX: (805) 522-9989

E-mail: frontiersales@frontierusa.com

Web: <http://www.frontierusa.com>

1A SURFACE MOUNT FAST RECOVERY RECTIFIERS

FFM101M-LFR THRU FFM107M-LFR

FEATURES

- FOR SURFACE MOUNTED APPLICATIONS
- LOW PROFILE PACKAGE
- BUILT-IN STRAIN RELIEF
- EASY PICK AND PLACE
- PLASTIC MATERIAL USED CARRIES UNDERWRITERS
LABORATORY CLASSIFICATION 94 V-0
- FAST SWITCHING
- HIGH TEMPERATURE SOLDERING 250°C/10 SECONDS AT TERMINALS
- ROHS

MECHANICAL DATA

- CASE: MOLDED PLASTIC SOD-123, SOD-123, DIMENSIONS IN INCHES AND (MILLIMETERS)
- TERMINALS: SOLDER PLATED
- POLARITY: INDICATED BY CATHODE BAND
- WEIGHT: 0.04 GRAMS

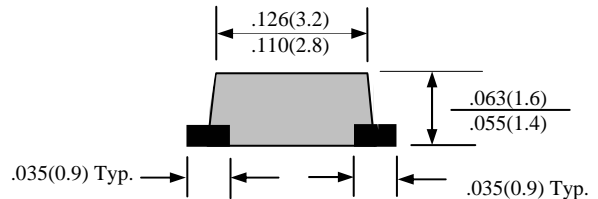
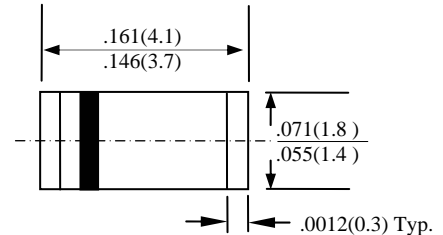

MAXIMUM RATINGS AND ELECTRICAL CHARACTERISTICS RATINGS AT 25°C AMBIENT TEMPERATURE UNLESS OTHERWISE SPECIFIED
SINGLE PHASE, HALF WAVE, 60 HZ, RESISTIVE OR INDUCTIVE LOAD. FOR CAPACITIVE LOAD, DERATE CURRENT BY 20%

RATINGS	SYMBOL	FFM101M-LF R	FFM102M-LF R	FFM103M-LF R	FFM104M-LF R	FFM105M-LF R	FFM106M-LF R	FFM107M-LF R	UNITS
MAXIMUM RECURRENT PEAK REVERSE VOLTAGE	V_{RRM}	50	100	200	400	600	800	1000	V
MAXIMUM RMS VOLTAGE	V_{RMS}	35	70	140	280	420	560	700	V
MAXIMUM DC BLOCKING VOLTAGE	V_{DC}	50	100	200	400	600	800	1000	V
MAXIMUM AVERAGE FORWARD RECTIFIED CURRENT AT $T_L=90^\circ\text{C}$	I_O	1.0							A
MAXIMUM OVERLOAD SURGE 8.3ms SINGLE HALF SINE-WAVE	I_{FSM}	30							A
TYPICAL JUNCTION CAPACITANCE (NOTE 1)	C_j	15							PF
TYPICAL THERMAL RESISTANCE (NOTE 2)	θ_{JL}	30							°C/W
STORAGE TEMPERATURE RANGE	T_{STG}	-55 TO + 150							°C
OPERATING TEMPERATURE RANGE	T_{OP}	-55 TO + 125							°C

ELECTRICAL CHARACTERISTICS (At $T_A = 25^\circ\text{C}$ UNLESS OTHERWISE NOTED)

CHARACTERISTICS	SYMBOL	FFM101M-LF R	FFM102M-LF R	FFM103M-LF R	FFM104M-LF R	FFM105M-LF R	FFM106M-LF R	FFM107M-LF R	UNITS
MAXIMUM FORWARD VOLTAGE AT 1.0A AND 25°C	V_F	1.3							V
MAXIMUM REVERSE CURRENT AT 25°C	I_R	5							μA
MAXIMUM REVERSE RECOVERY TIME (NOTE 3)	T_{RR}	150				250	500		nS
MARKING		F1	F2	F3	F4	F5	F6	F7	

- NOTE:
1. MEASURED AT 1.0 MHZ AND APPLIED REVERSE VOLTAGE OF 4.0 V
 2. THERMAL RESISTANCE FROM JUNCTION TO TERMINAL 5.0mm² (.013 mm THICK) LAND AREAS
 3. REVERSE RECOVERY TEST CONDITIONS: $I_F=0.5\text{A}$, $I_R=1.0\text{A}$, $I_{RR}=0.25\text{A}$

RATINGS AND CHARACTERISTIC CURVE FFM101M-LFR THRU FFM107M-LFR

FIG. 1-TEST CIRCUIT DIAGRAM AND REVERSE RECOVERY TIME CHARACTERISTIC

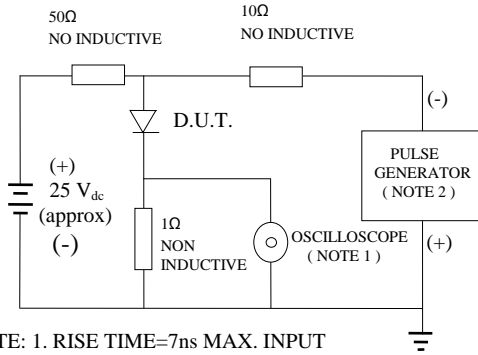

NOTE: 1. RISE TIME=7ns MAX. INPUT IMPEDANCE=1 MOhms 22PF
 2. RISE TIME =10ns MAX. SOURCE IMPEDANCE=50 OHMS

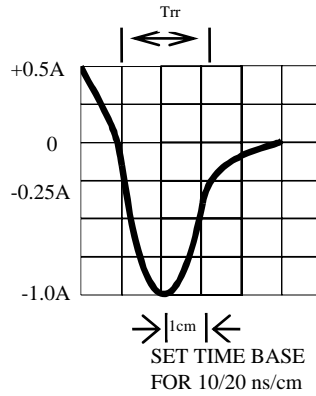

Fig. 2-MAXIMUM CURRENT DERATING CURVE

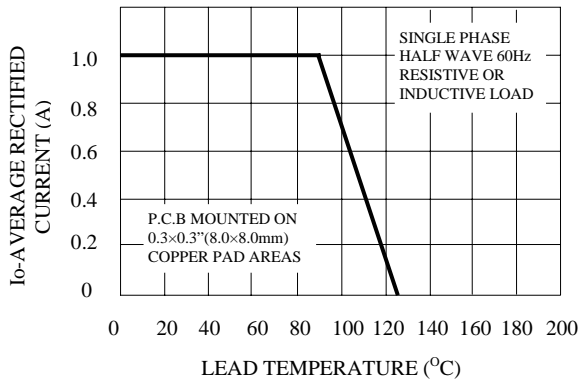

FIG. 3-TYPICAL JUNCTION CAPACITANCE

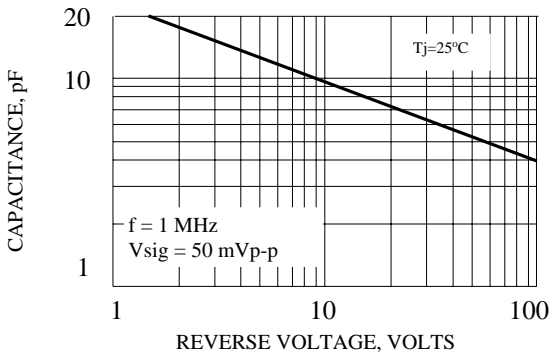

FIG. 4-TYPICAL REVERSE CHARACTERISTICS

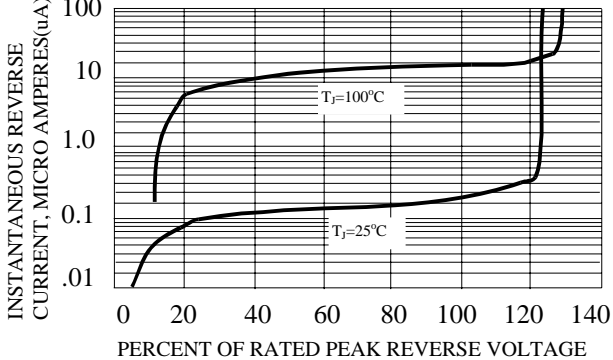

Fig. 5-MAXIMUM FORWARD SURGE CURRENT

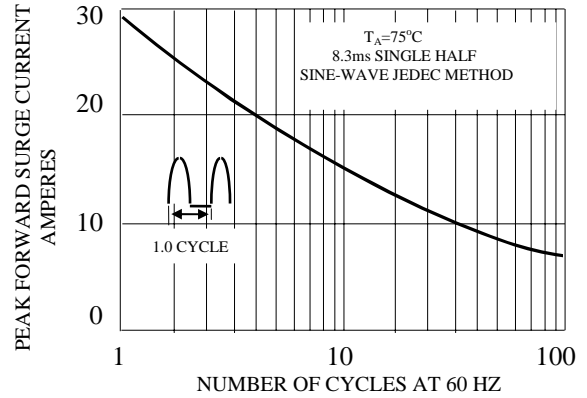

FIG. 6-TYPICAL INSTANTANEOUS FORWARD CHARACTERISTICS

