



DESCRIPTION:

The JX007 SCR series provide high dv/dt rate with strong resistance to electromagnetic interference. They are especially recommended for use on residual current circuit breaker, straight hair, igniter etc.

MAIN FEATURES

Symbol	Value	Unit
$I_{T(RMS)}$	0.8	A
I_{GT}	≤ 120	μA
V_{DRM} / V_{RRM}	400/600	V

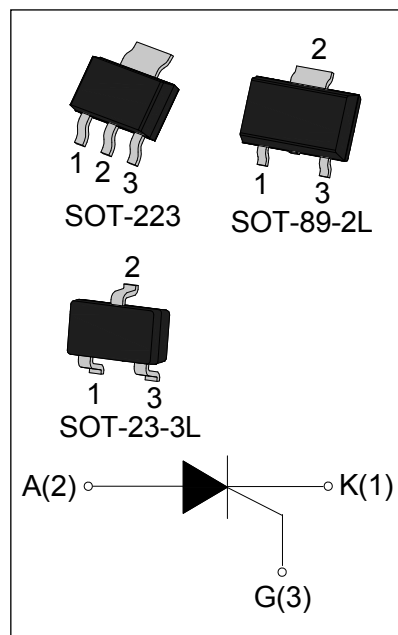

ABSOLUTE MAXIMUM RATINGS

Parameter	Symbol	Value	Unit	
Storage junction temperature range	T_{stg}	-40-150	$^{\circ}C$	
Operating junction temperature range	T_j	-40-125 ^①	$^{\circ}C$	
Repetitive peak off-state voltage	V_{DRM}	400/600	V	
Repetitive peak reverse voltage	V_{RRM}	400/600	V	
RMS on-state current	SOT-23-3L ($T_c=50^{\circ}C$)	$I_{T(RMS)}$	0.8	A
	SOT-223($T_c=70^{\circ}C$)			
	SOT-89-2L($T_c=61^{\circ}C$)			
Non repetitive surge peak on-state current (tp=10ms)	I_{TSM}	8	A	
I^2t value for fusing (tp=10ms)	I^2t	0.32	A^2s	
Critical rate of rise of on-state current	di/dt	50	$A/\mu s$	
Peak gate current (tp=20 μs , $T_j=125^{\circ}C$)	I_{GM}	0.2	A	
Peak gate power (tp=20 μs , $T_j=125^{\circ}C$)	P_{GM}	0.5	W	
Average gate power dissipation($T_j=125^{\circ}C$)	$P_{G(AV)}$	0.1	W	

NOTE 1: When we parallel connect a $\leq 1K\Omega$ resistor between Gate and Cathode, the T_j can reach $125^{\circ}C$; if without this resistor, the T_j only can reach $110^{\circ}C$.

ELECTRICAL CHARACTERISTICS ($T_j=25^{\circ}\text{C}$ unless otherwise specified)

Symbol	Test Condition	Value			Unit
		MIN.	TYP.	MAX.	
I_{GT}	$V_D=12\text{V } R_L=33\Omega$	-	30	120	μA
V_{GT}		-	0.6	0.8	V
V_{GD}	$V_D=V_{DRM} T_j=125^{\circ}\text{C}$	0.2	-	-	V
I_L	$I_G=1.2 I_{GT}$	-	-	5	mA
I_H	$I_T=0.05\text{A}$	-	-	3	mA
dV/dt	$V_D=2/3V_{DRM} T_j=125^{\circ}\text{C} R_{GK}=1\text{K}\Omega$	10	-	-	V/ μs
T_{on}	$I_{TM}=2\text{A } V_D=V_{DRM(max)} I_G=10\text{mA}$ $dI_G/dt=0.1\text{A}/\mu\text{s}$	-	-	3	μs

STATIC CHARACTERISTICS

Symbol	Parameter		Value(MAX)	Unit
V_{TM}	$I_T=1\text{A } t_p=380\mu\text{s}$	$T_j=25^{\circ}\text{C}$	1.5	V
I_{DRM}	$V_D=V_{DRM} V_R=V_{RRM}$	$T_j=25^{\circ}\text{C}$	5	μA
I_{RRM}		$T_j=125^{\circ}\text{C}$	100	μA

THERMAL RESISTANCES

Symbol	Parameter		Value	Unit
$R_{th(j-c)}$	junction to case	SOT-23-3L	113	$^{\circ}\text{C}/\text{W}$
		SOT-223	50	
		SOT-89-2L	60	
$R_{th(j-a)}$	junction to ambient	SOT-23-3L	125	$^{\circ}\text{C}/\text{W}$
		SOT-223	60	
		SOT-89-2L	90	

ORDERING INFORMATION

<p>J</p> <p>JieJie Microelectronics Co.,Ltd</p> <p>Sensitive gate SCRs</p>	<p>X</p>	<p>007</p> <p>IT(RMS):0.8A</p>	<p>V</p> <p>V:SOT-223 L:SOT-23-3L N2:SOT-89-2L</p>
---	-----------------	---------------------------------------	---

PACKAGE MECHANICAL DATA

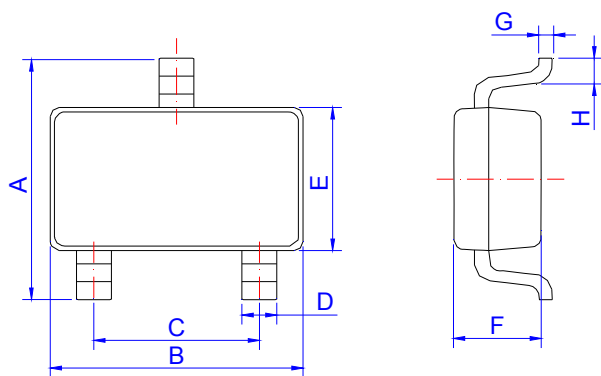

SOT-23-3L

Ref.	Dimensions					
	Millimeters			Inches		
	Min.	Typ.	Max.	Min.	Typ.	Max.
A	2.65	2.80	2.95	0.104	0.110	0.116
B	2.82	2.92	3.02	0.111	0.115	0.119
C	1.80	1.90	2.00	0.071	0.075	0.079
D	0.30	0.35	0.50	0.012	0.014	0.020
E	1.50	1.60	1.70	0.059	0.063	0.067
F	1.07	1.17	1.27	0.042	0.046	0.050
G	0.05	0.15	0.25	0.002	0.006	0.010
H	0.25	0.40	0.55	0.010	0.016	0.022

FOOTPRINT-SOT-23-3L (dimensions in mm)

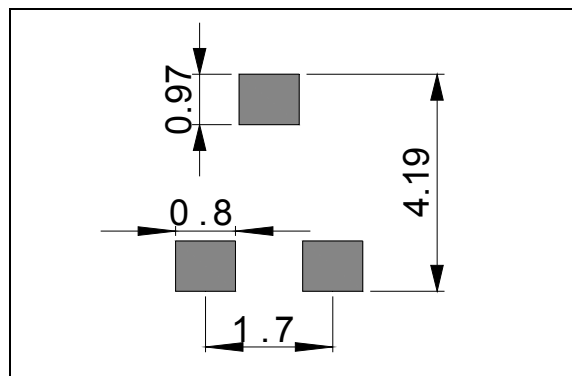

PACKAGE MECHANICAL DATA

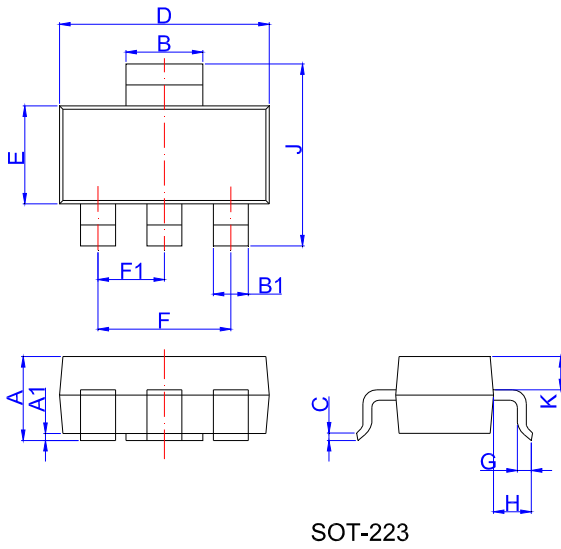

Ref.	Dimensions					
	Millimeters			Inches		
	Min.	Typ.	Max.	Min.	Typ.	Max.
A	1.5	1.6	1.8	0.059	0.063	0.071
A1	0.01	0.06	0.10	0.001	0.002	0.004
B	2.9	3.0	3.1	0.114	0.118	0.122
B1	0.6	0.7	0.8	0.024	0.028	0.031
C	0.22	0.26	0.32	0.009	0.010	0.013
D	6.3	6.5	6.7	0.248	0.256	0.264
E	3.3	3.5	3.7	0.130	0.138	0.146
F		4.6			0.181	
F1		2.3			0.091	
G	0.7	0.9	1.1	0.028	0.035	0.043
H	1.5	1.75	2.0	0.059	0.069	0.079
J	6.7	7.0	7.3	0.264	0.276	0.287
K	0.8	0.9	1.0	0.031	0.035	0.039

FOOTPRINT-SOT-223 (dimensions in mm)

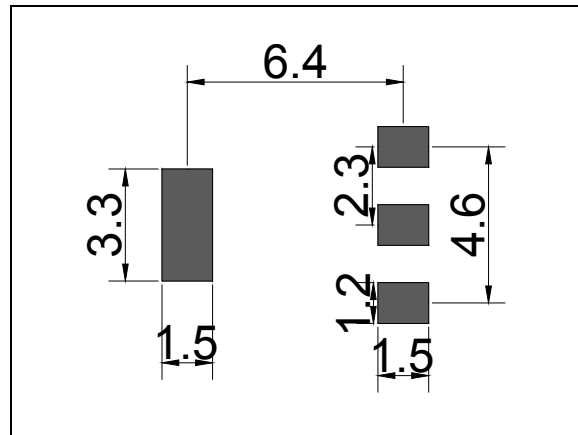

PACKAGE MECHANICAL DATA

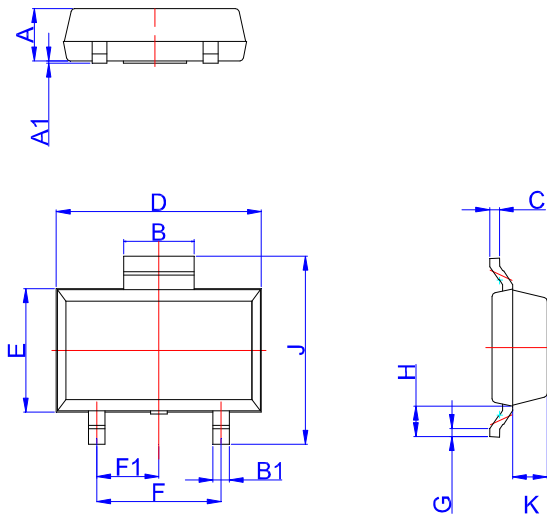

SOT-89-2L

Ref.	Dimensions					
	Millimeters			Inches		
	Min.	Typ.	Max.	Min.	Typ.	Max.
A	1.3	1.4	1.5	0.051	0.055	0.059
A1	0.01	0.06	0.10	0.001	0.002	0.004
B	1.6	1.7	1.8	0.063	0.067	0.071
B1	0.3	0.4	0.5	0.012	0.016	0.020
C	0.22	0.254	0.32	0.009	0.010	0.013
D	4.75	4.95	5.15	0.187	0.195	0.203
E	2.75	2.95	3.15	0.108	0.116	0.124
F		3.0			0.118	
F1		1.5			0.059	
G	0.2	0.3	0.4	0.008	0.012	0.016
H	0.58	0.78	0.98	0.023	0.031	0.039
J	4.3	4.5	4.7	0.169	0.177	0.185
K		0.88			0.035	

FOOTPRINT-SOT-89-2L (dimensions in mm)

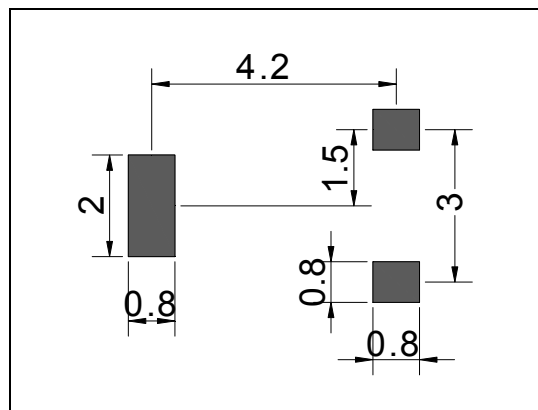

FIG.1: Maximum power dissipation versus RMS on-state current

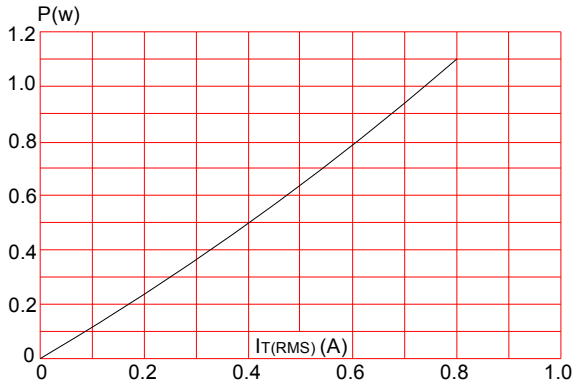

FIG.3: Surge peak on-state current versus number of cycles

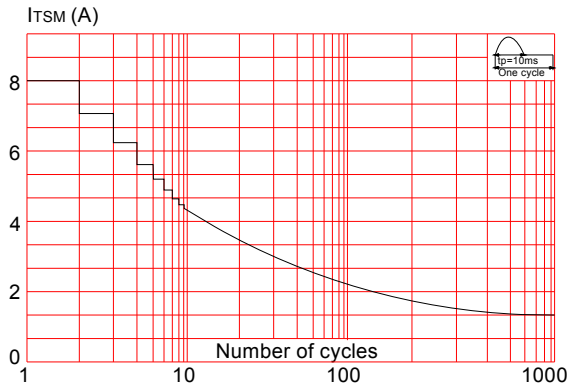

FIG.5: Non-repetitive surge peak on-state current for a sinusoidal pulse with width $t_p < 10\text{ms}$, and corresponding value of I^2t ($dI/dt < 50\text{A}/\mu\text{s}$)

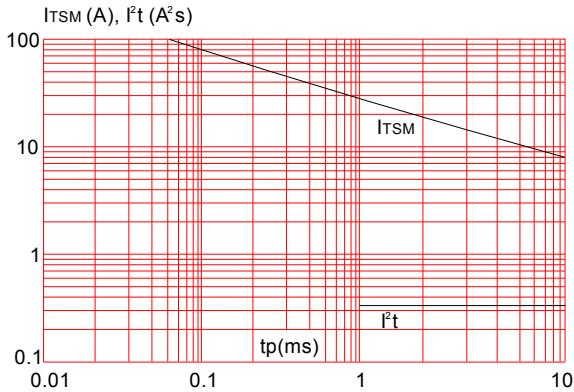

FIG.2: RMS on-state current versus ambient temperature (printed circuit board FR4,copper thickness:35 μm)(full cycle)

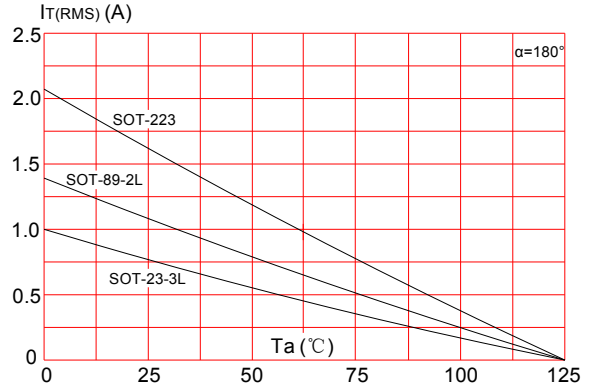

FIG.4: On-state characteristics (maximum values)

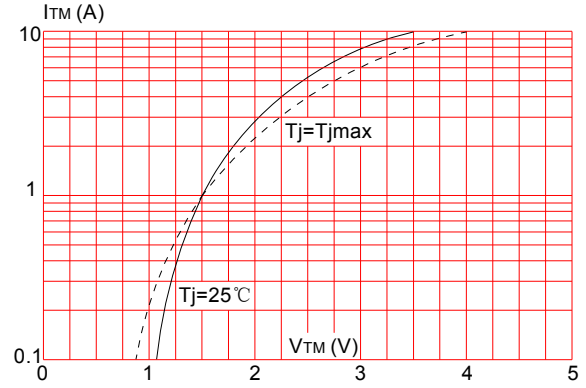
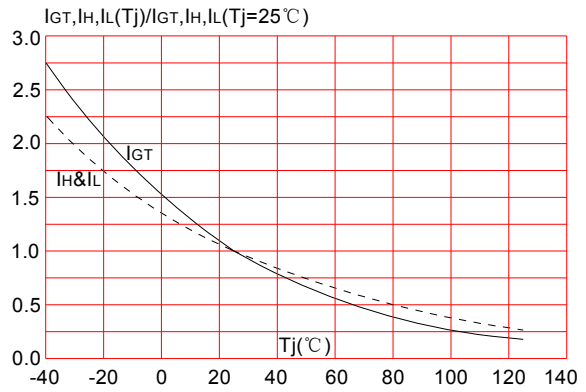
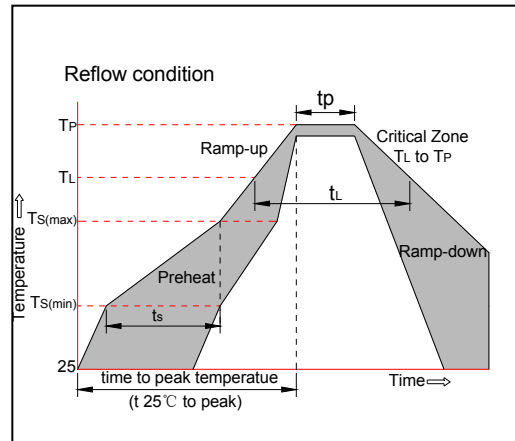

FIG.6: Relative variations of gate trigger current, holding current and latching current versus junction temperature



SOLDERING PARAMETERS

Reflow Condition		Pb-Free assembly (see figure at right)
Pre Heat	-Temperature Min ($T_{s(min)}$)	+150°C
	-Temperature Max ($T_{s(max)}$)	+200°C
	-Time (Min to Max) (t_s)	60-180 secs.
Average ramp up rate (Liquidus Temp (T_L) to peak)		3°C/sec. Max
$T_{s(max)}$ to T_L - Ramp-up Rate		3°C/sec. Max
Reflow	-Temperature(T_L) (Liquidus)	+217°C
	-Temperature(t_L)	60-150 secs.
Peak Temp (T_p)		+260(+0/-5)°C
Time within 5°C of actual Peak Temp (t_p)		20-40secs.
Ramp-down Rate		6°C/sec. Max
Time 25°C to Peak Temp (T_P)		8 min. Max
Do not exceed		+260°C



Information furnished in this document is believed to be accurate and reliable. However, Jiangsu JieJie Microelectronics Co.,Ltd assumes no responsibility for the consequences of use without consideration for such information nor use beyond it. Information mentioned in this document is subject to change without notice, apart from that when an agreement is signed, Jiangsu JieJie complies with the agreement. Products and information provided in this document have no infringement of patents. Jiangsu JieJie assumes no responsibility for any infringement of other rights of third parties which may result from the use of such products and information. This document is the seventh version which is made in 21-Feb.-2019. This document supersedes and replaces all information previously supplied.

 is a registered trademark of Jiangsu JieJie Microelectronics Co.,Ltd.

Copyright ©2019 Jiangsu JieJie Microelectronics Co.,Ltd. Printed All rights reserved.