



AD-ESD24VC2 Plastic-Encapsulated Diode

AD-ESD24VC2 Uni-direction ESD protection diode

DESCRIPTION

To protect voltage sensitive electronic components from ESD and other transients. Excellent clamping capability, low leakage, low capacitance and fast response time provide best in class protection on designs which are exposed to ESD.

The combination of small size, low capacitance and high level of ESD protection makes the product a flexible solution for applications such as HDMI, Display Port TM and MDDI interfaces. It is designed to replace multiplayer varistors (MLV).

FEATURES

- Uni-directional ESD protection of one line
- Reverse stand-off voltage: 24V
- Low reverse clamping voltage
- Low leakage current
- Excellent package: 2.90mm X 1.30mm X 1.00mm
- Fast response time
- JESD22-A114-B ESD rating of class 3B per human body model
- IEC 61000-4-2 level 3 ESD protection
- AEC-Q101 qualified

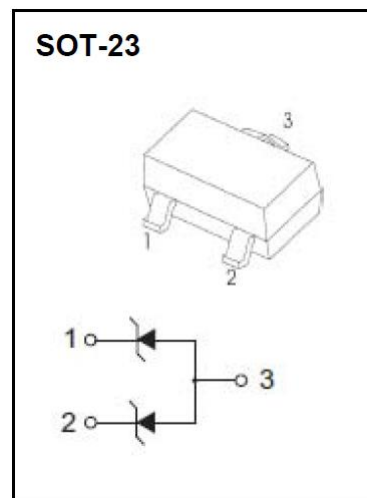

APPLICATIONS

- Computers and peripherals
- Audio and video equipment
- Cellular handsets and accessories
- Digital cameras
- Portable electronics
- Other electronics equipment communication systems

MARKING

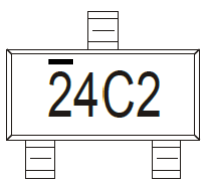

24C2 = Device code

MAXIMUM RATINGS (T_j = 25°C unless otherwise specified)

Parameter		Symbol	Value	Unit
IEC 61000-4-2 ESD voltage	Air model	V _{ESD} ¹⁾	±25	kV
	Contact model		±25	
JESD22-A114-B ESD voltage per human body model			±16	
ESD voltage per machine model			±0.4	
Peak pulse power		P _{PP} ²⁾	406	W
Peak pulse current		I _{PP} ²⁾	7	A
Maximum lead solder temperature (10 second duration)		T _L	260	°C
Operation junction and storage temperature range		T _j , T _{stg}	-55 ~ 150	°C

ESD STANDARD COMPLIANCE

IEC61000-4-2 standard

Contact discharge		Air discharge	
Level	Test voltage (kV)	Level	Test voltage (kV)
1	2	1	2
2	4	2	4
3	6	3	8
4	8	4	15

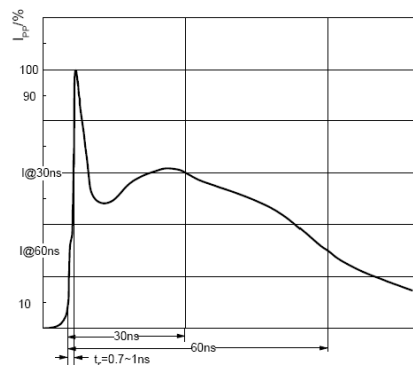

ESD pulse waveform according to IEC61000-4-2

JESD22-A114-B standard

ESD class	Human body discharge (V)
0	0 ~ 249
1A	250 ~ 499
1B	500 ~ 999
1C	1000 ~ 1999
2	2000 ~ 3999
3A	4000 ~ 7999
3B	8000 ~ 15999

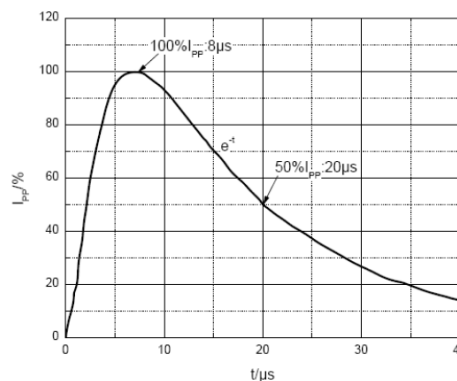

8/20μs pulse waveform according to IEC 61000-4-5

ELECTRICAL CHARACTERISTICS ($T_j = 25^\circ\text{C}$ unless otherwise specified)

Parameter	Symbol
Clamping voltage @ I_{PP}	V_C
Peak pulse current	I_{PP}
Breakdown voltage @ I_T	V_{BR}
Test current	I_T
Reverse leakage current @ V_{RWM}	I_R
Reverse standoff voltage	V_{RWM}
Forward voltage @ I_F	V_F
Forward current	I_F

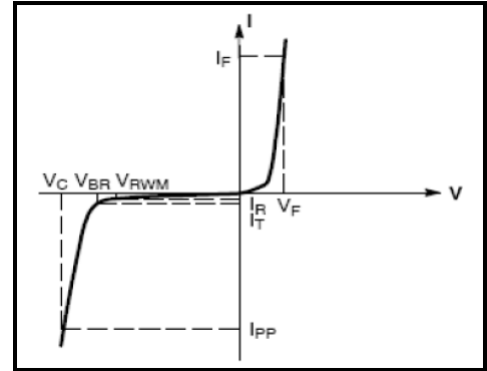
**V-I characteristics for a uni-directional TVS**

Parameter	Symbol	Test condition	Min	Typ	Max	Unit
Reverse standoff voltage	$V_{RWM}^{3)}$		-	-	24	V
Reverse leakage current	I_R	$V_{RWM} = 24\text{V}$	-	-	1	μA
Breakdown voltage	V_{BR}	$I_T = 1\text{mA}$	26.7	-	33	V
Clamping voltage	$V_C^{2)}$	$I_{PP} = 9\text{A}$	-	-	58	V
Forward voltage	V_F	$I_F = 10\text{mA}$	-	-	0.9	V
Junction capacitance	C_J	$V_R = 0\text{V}, f = 1\text{MHz}$	-	36	-	pF

1) Device stressed with ten non-repetitive ESD pulses.

2) Non-repetitive current pulse 8/20 μs exponential decay waveform according to IEC61000-4-5.

3) Other voltages available upon request.

TYPICAL CHARACTERISTICS

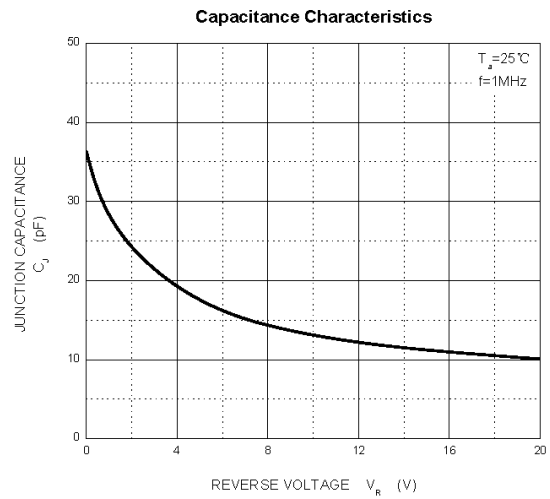
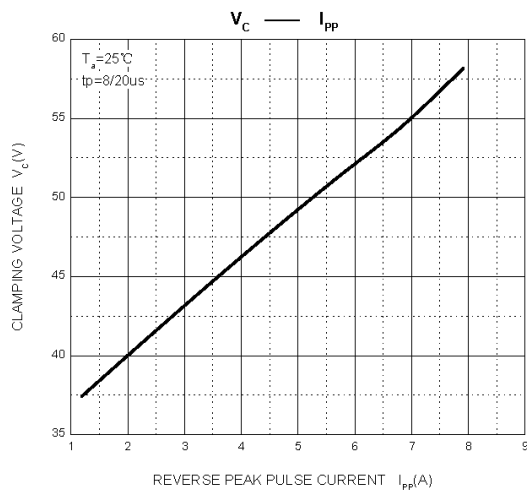
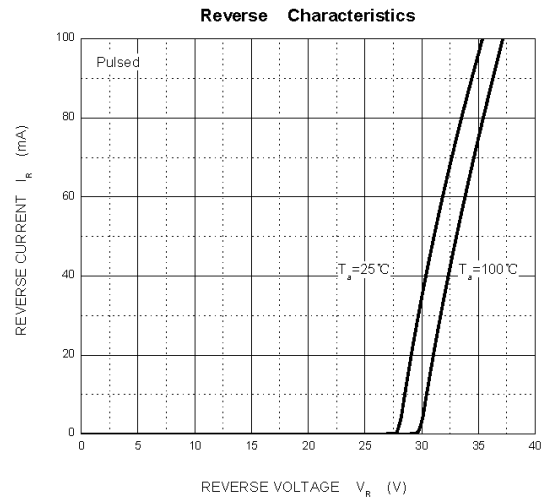
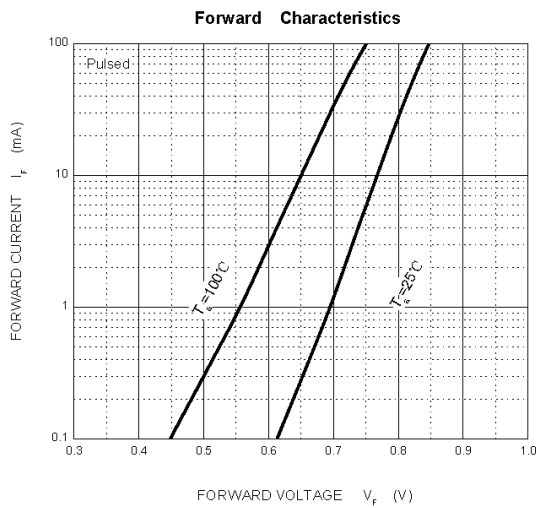

SOT-23 PACKAGE OUTLINE DIMENSIONS

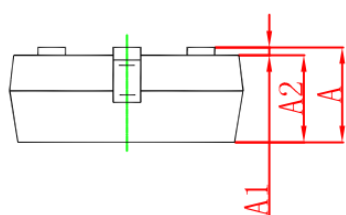
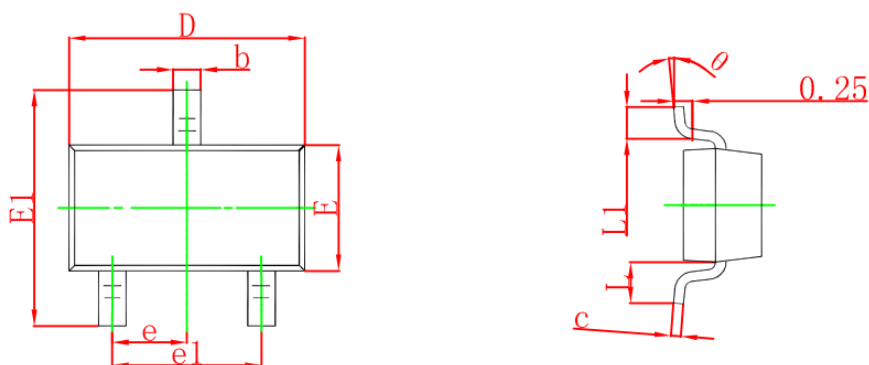

Symbol	Dimensions In Millimeters		Dimensions In Inches	
	Min	Max	Min	Max
A	0.900	1.150	0.035	0.045
A1	0.000	0.100	0.000	0.004
A2	0.900	1.050	0.035	0.041
b	0.300	0.500	0.012	0.020
c	0.080	0.150	0.003	0.006
D	2.800	3.000	0.110	0.118
E	1.200	1.400	0.047	0.055
E1	2.250	2.550	0.089	0.100
e	0.950 TYP		0.037 TYP	
e1	1.800	2.000	0.071	0.079
L	0.550 REF		0.022 REF	
L1	0.300	0.500	0.012	0.020
θ	0°	8°	0°	8°

SOT-23 SUGGESTED PAD LAYOUT

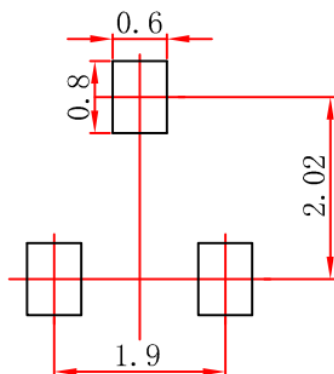

Note:

1. Controlling dimension in millimeters.
2. General tolerance: ±0.05mm.
3. The pad layout is for reference purpose only.

SOT-23 TAPE AND REEL

SOT-23 Embossed Carrier Tape

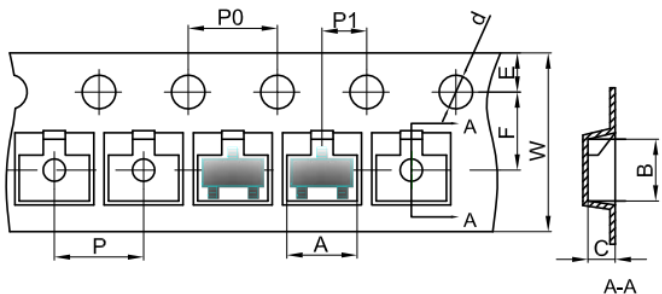

Packaging Description:
 SOT-23 parts are shipped in tape. The carrier tape is made from a dissipative (carbon filled) polycarbonate resin. The cover tape is a multilayer film (Heat Activated Adhesive in nature) primarily composed of polyester film, adhesive layer, sealant, and anti-static sprayed agent. These reeled parts in standard option are shipped with 3,000 units per 7" or 17.8cm diameter reel. The reels are clear in color and is made of polystyrene plastic (anti-static coated).

Dimensions are In millimeter										
Pkg type	A	B	C	d	E	F	P0	P	P1	W
SOT-23	3.15	2.77	1.22	Ø1.50	1.75	3.50	4.00	4.00	2.00	8.00

SOT-23 Tape Leader and Trailer

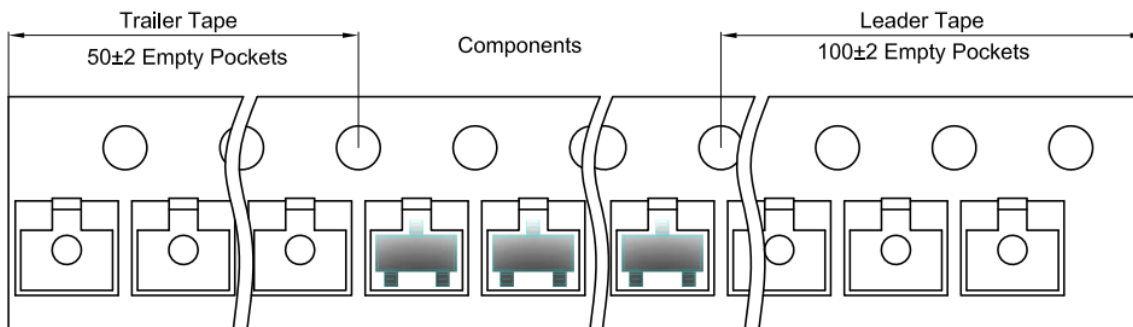

SOT-23 Reel

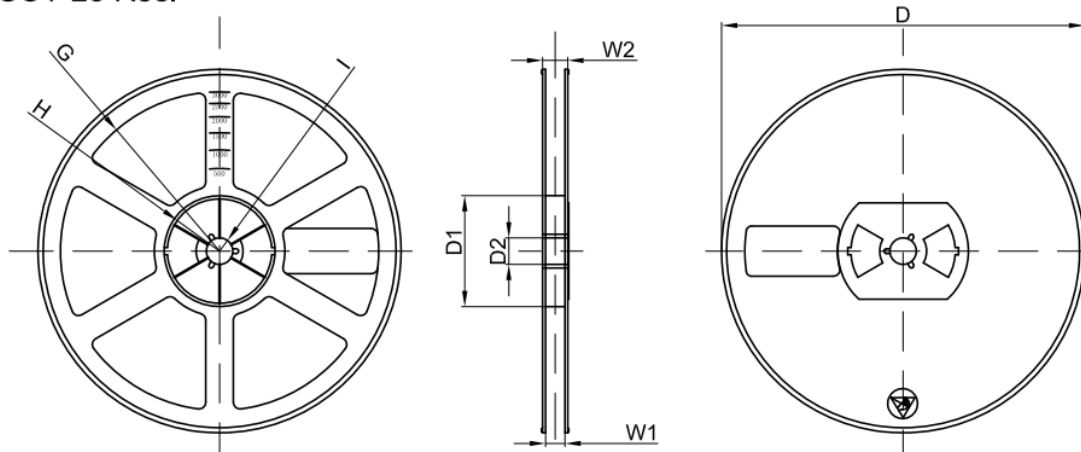

Dimensions are in millimeter								
Reel Option	D	D1	D2	G	H	I	W1	W2
7"Dia	Ø178.00	54.40	13.00	R78.00	R25.60	R6.50	9.50	12.30

REEL	Reel Size	Box	Box Size(mm)	Carton	Carton Size(mm)	G.W.(kg)
3000 pcs	7 inch	45,000 pcs	203×203×195	180,000 pcs	438×438×220	

PUBLISHED BY**JIANGSU CHANGJING ELECTRONICS TECHNOLOGY CO., LTD.**

13th Floor, C Block, Tengfei Building, Yan Chuang Yuan, Nanjing Jiangbei New Area, China

LEGAL DISCLAIMER

The information given in this document shall in no event be regarded as a guarantee of conditions or characteristics. With respect to any examples, hints or typical values stated herein and/or any information regarding the application of the device, JSCJ hereby disclaims any and all warranties and liabilities of any kind, including without limitation, warranties of non-infringement of intellectual property rights of any third party.

In addition, any information given in this document is subject to customer's compliance with its obligations stated in this document and any applicable legal requirements, norms and standards concerning customer's products and any use of the product of JSCJ in customer's applications.

The data contained in this document is exclusively intended for technically trained staff. It is the responsibility of customer's technical departments to evaluate the suitability of the product for the intended application and the completeness of the product information given in this document with respect to such application.

INFORMATION

For further information on technology, delivery terms and conditions as well as prices, please contact your nearest JSCJ office (www.jscj-elec.com).

WARNINGS

Due to technical requirements, products may contain dangerous substances. For information on the types in question, please contact your nearest JSCJ office.

Except as otherwise explicitly approved by JSCJ in a written document signed by authorized representatives of JSCJ, JSCJ's products may not be used in any applications where a failure of the product or any consequences of the use thereof can reasonably be expected to result in personal injury.