

## IL211AT/IL212AT/IL213AT PHOTOTRANSISTOR SMALL OUTLINE SURFACE MOUNT OPTOCOUPLER

### FEATURES

- **High Current Transfer Ratio**  
**IL211AT—20% Minimum**  
**IL212AT—50% Minimum**  
**IL213AT—100% Minimum**
- **Isolation Voltage, 2500 VAC<sub>RMS</sub>**
- **Electrical Specifications Similar to Standard 6 Pin Coupler**
- **Industry Standard SOIC-8 Surface Mountable Package**
- **Standard Lead Spacing, .05"**
- **Available in Tape and Reel (suffix T) (Conforms to EIA Standard RS481A)**
- **Compatible with Dual Wave, Vapor Phase and IR Reflow Soldering**
- **Underwriters Lab File #E52744 (Code Letter P)**

### DESCRIPTION

The IL211AT/212AT/213AT are optically coupled pairs with a Gallium Arsenide infrared LED and a silicon NPN phototransistor. Signal information, including a DC level, can be transmitted by the device while maintaining a high degree of electrical isolation between input and output. The IL211AT//212AT/213AT comes in a standard SOIC-8 small outline package for surface mounting which makes it ideally suited for high density applications with limited space. In addition to eliminating through-holes requirements, this package conforms to standards for surface mounted devices.

A choice of 20, 50, and 100% minimum CTR at  $I_F=10$  mA makes these optocouplers suitable for a variety of different applications.

### Maximum Ratings

#### Emitter

Peak Reverse Voltage ..... 6.0 V  
 Continuous Forward Current ..... 60 mA  
 Power Dissipation at 25°C ..... 90 mW  
 Derate Linearly from 25°C ..... 1.2 mW/°C

#### Detector

Collector-Emitter Breakdown Voltage ..... 30 V  
 Emitter-Collector Breakdown Voltage ..... 7 V  
 Collector-Base Breakdown Voltage ..... 70 V  
 Power Dissipation ..... 150 mW  
 Derate Linearly from 25°C ..... 2.0 mW/°C

#### Package

Total Package Dissipation at 25°C Ambient (LED + Detector) ..... 280 mW  
 Derate Linearly from 25°C ..... 3.3 mW/°C  
 Storage Temperature ..... -55°C to +150°C  
 Operating Temperature ..... -55°C to +100°C  
 Soldering Time at 260°C ..... 10 sec.

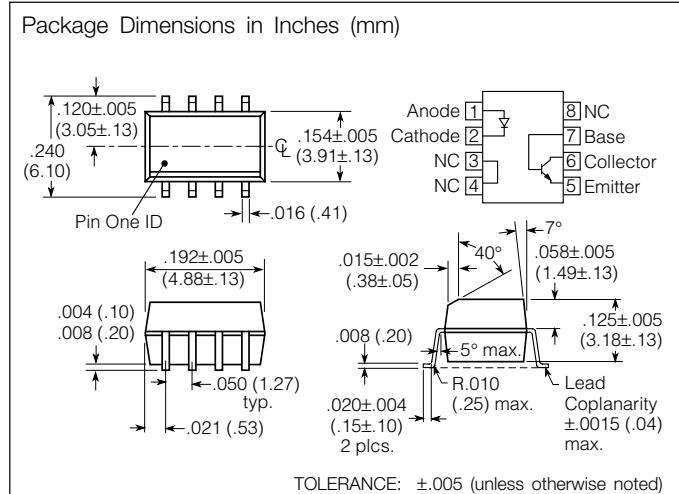

### Characteristics (T<sub>A</sub>=25°C)

	Symbol	Min.	Typ.	Max.	Unit	Condition
<b>Emitter</b>						
Forward Voltage	V <sub>F</sub>	1.3	1.5		V	I <sub>F</sub> =10 mA
Reverse Current	I <sub>R</sub>	0.1	100		μA	V <sub>R</sub> =6.0 V
Capacitance	C <sub>O</sub>	25			pF	V <sub>R</sub> =0
<b>Detector</b>						
Breakdown Voltage	BV <sub>CEO</sub>	30			V	I <sub>C</sub> =10 μA
	BV <sub>ECO</sub>	7			V	I <sub>E</sub> =10 μA
Collector-Emitter Dark Current	I <sub>CEOdark</sub>	5	50		nA	V <sub>CE</sub> =10 V, I <sub>F</sub> =0
Collector-Emitter Capacitance	C <sub>CE</sub>	10			pF	V <sub>CE</sub> =0
<b>Package</b>						
DC Current Transfer	CTR <sub>DC</sub>				%	I <sub>F</sub> =10 mA, V <sub>CE</sub> =5 V
IL211AT		20	50			
IL212AT		50	80			
IL213AT		100	130			
Collector-Emitter Saturation Voltage	V <sub>CE sat</sub>			0.4		I <sub>F</sub> =10 mA, I <sub>C</sub> =2.0 mA
Isolation Test Voltage	V <sub>IO</sub>	2500				VAC <sub>RMS</sub>
Capacitance, Input to Output	C <sub>IO</sub>	0.5			pF	
Resistance, Input to Output	R <sub>IO</sub>	100			GΩ	
Switching Time	t <sub>ON</sub> , t <sub>OFF</sub>	3.0			μs	I <sub>C</sub> =2 mA, R <sub>E</sub> =100 Ω, V <sub>CE</sub> =10 V

Specifications subject to change.

Figure 1. Forward voltage versus forward current

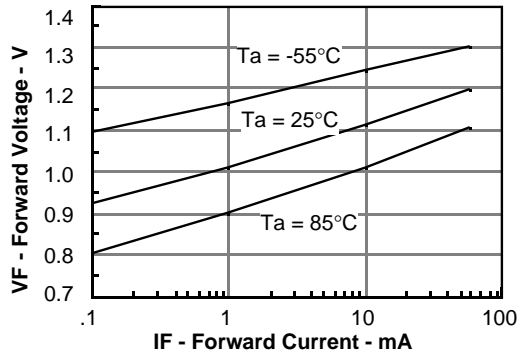

Figure 2. Normalized non-saturated and saturated CTRce versus LED current

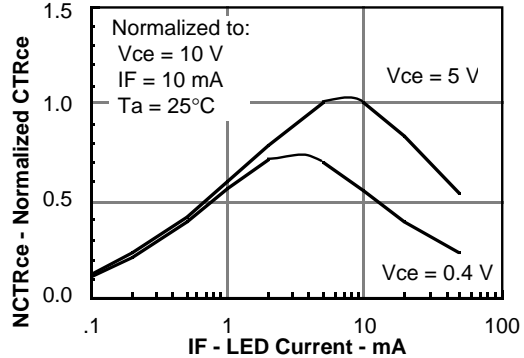

Figure 3. Collector-emitter current versus LED current

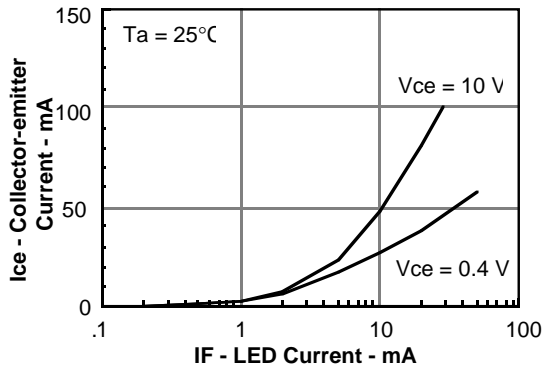

Figure 4. Normalized collector-base photocurrent versus LED current

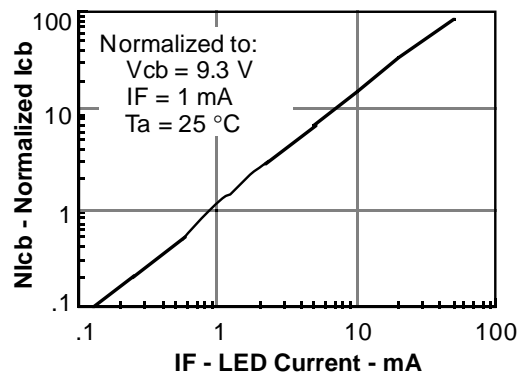

Figure 5. Normalized collector-base photocurrent versus LED current

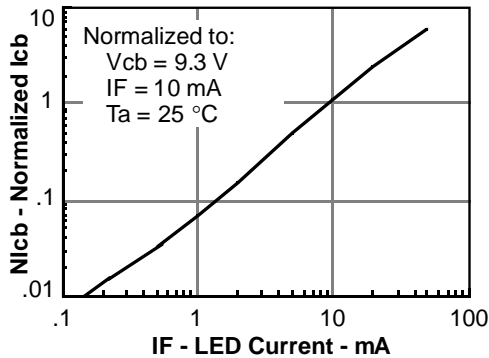

Figure 6. Collector-base photocurrent versus LED current

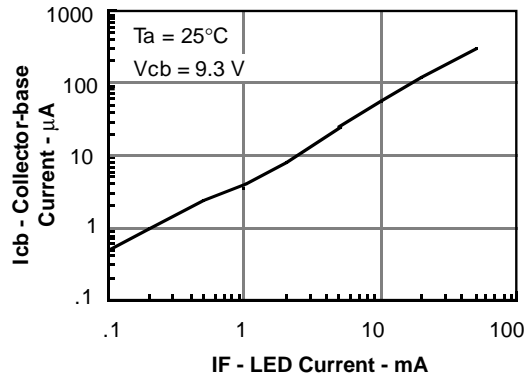

Figure 7. Collector-emitter leakage current versus temperature

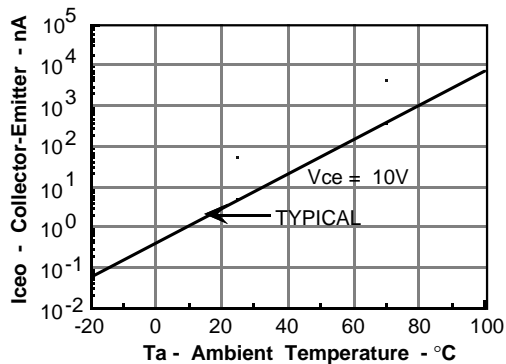
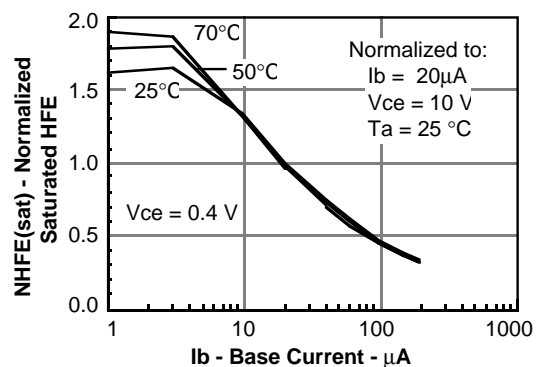
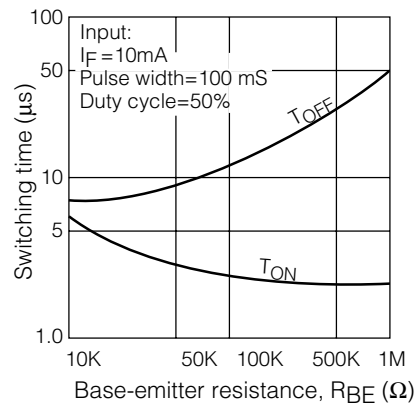

Figure 8. Normalized saturated HFE versus base current and temperature



**Figure 9. Typical switching characteristics versus base resistance (saturated operation)**



**Figure 10. Typical switching times versus load resistance**

