

Dual Bias Resistor Transistors

PNP Silicon Surface Mount Transistors with Monolithic Bias Resistor Network

The BRT (Bias Resistor Transistor) contains a single transistor with a monolithic bias network consisting of two resistors; a series base resistor and a base-emitter resistor. These digital transistors are designed to replace a single device and its external resistor bias network. The BRT eliminates these individual components by integrating them into a single device. In the LMUN5111DW1T1G series, two BRT devices are housed in the SOT-363 package which is ideal for low-power surface mount applications where board space is at a premium.

- . Simplifies Circuit Design
- . Reduces Board Space
- . Reduces Component Count
- . Available in 8 mm, 7 inch/3000 Unit Tape and Reel
- . We declare that the material of product compliance with RoHS requirements.

Ordering Information

Device	Package	Shipping
LMUN51XXDW1T1G	SC-88	3000/Tape&Reel
LMUN51XXDW1T3G	SC-88	10000/Tape&Reel

MAXIMUM RATINGS (T_A = 25°C unless otherwise noted, common for Q₁ and Q₂)

Rating	Symbol	Value	Unit
Collector-Base Voltage	V _{CBO}	-50	Vdc
Collector-Emitter Voltage	V _{CEO}	-50	Vdc
Collector Current	I _C	-100	mAdc

THERMAL CHARACTERISTICS

Characteristic (One Junction Heated)	Symbol	Max	Unit
Total Device Dissipation T _A = 25°C	P _D	187 (Note 1.) 256 (Note 2.)	mW
Derate above 25°C		1.5 (Note 1.) 2.0 (Note 2.)	mW/°C
Thermal Resistance – Junction-to-Ambient	R _{θJA}	670 (Note 1.) 490 (Note 2.)	°C/W
Characteristic (Both Junctions Heated)	Symbol	Max	Unit
Total Device Dissipation T _A = 25°C	P _D	250 (Note 1.) 385 (Note 2.)	mW
Derate above 25°C		2.0 (Note 1.) 3.0 (Note 2.)	mW/°C
Thermal Resistance – Junction-to-Ambient	R _{θJA}	493 (Note 1.) 325 (Note 2.)	°C/W
Thermal Resistance – Junction-to-Lead	R _{θJL}	188 (Note 1.) 208 (Note 2.)	°C/W
Junction and Storage Temperature	T _J , T _{stg}	-55 to +150	°C

1. FR-4 @ Minimum Pad 2. FR-4 @ 1.0 x 1.0 inch Pad

LMUN5111DW1T1G Series

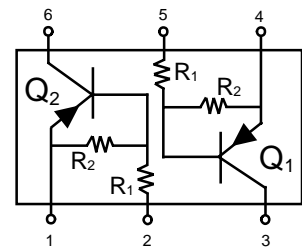
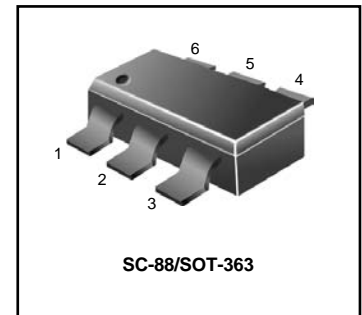

MARKING DIAGRAM

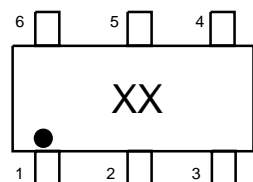

xx = Device Marking
(See Page 2)

DEVICE MARKING INFORMATION

See specific marking information in the device marking table on page 2 of this data sheet.

LMUN5111DW1T1G Series

DEVICE MARKING AND RESISTOR VALUES

Device	Package	Marking	R ₁ (K)	R ₂ (K)	Shipping
LMUN5111DW1T1G	SOT-363	0A	10	10	3000/Tape & Reel
LMUN5112DW1T1G	SOT-363	0B	22	22	3000/Tape & Reel
LMUN5113DW1T1G	SOT-363	0C	47	47	3000/Tape & Reel
LMUN5114DW1T1G	SOT-363	0D	10	47	3000/Tape & Reel
LMUN5115DW1T1G (Note 3.)	SOT-363	0E	10	–	3000/Tape & Reel
LMUN5116DW1T1G (Note 3.)	SOT-363	0F	4.7	–	3000/Tape & Reel
LMUN5130DW1T1G (Note 3.)	SOT-363	0G	1.0	1.0	3000/Tape & Reel
LMUN5131DW1T1G (Note 3.)	SOT-363	0H	2.2	2.2	3000/Tape & Reel
LMUN5132DW1T1G (Note 3.)	SOT-363	0J	4.7	4.7	3000/Tape & Reel
LMUN5133DW1T1G (Note 3.)	SOT-363	0K	4.7	47	3000/Tape & Reel
LMUN5134DW1T1G (Note 3.)	SOT-363	0L	22	47	3000/Tape & Reel
LMUN5135DW1T1G (Note 3.)	SOT-363	0M	2.2	47	3000/Tape & Reel
LMUN5136DW1T1G (Note 3.)	SOT-363	0N	100	100	3000/Tape & Reel
LMUN5137DW1T1G (Note 3.)	SOT-363	0P	47	22	3000/Tape & Reel

ELECTRICAL CHARACTERISTICS

(T_A = 25°C unless otherwise noted, common for Q₁ and Q₂)

Characteristic	Symbol	Min	Typ	Max	Unit
----------------	--------	-----	-----	-----	------

OFF CHARACTERISTICS

Collector-Base Cutoff Current (V _{CB} = -50 V, I _E = 0)	I _{CBO}	–	–	-100	nAdc	
Collector-Emitter Cutoff Current (V _{CE} = -50 V, I _B = 0)	I _{CEO}	–	–	-500	nAdc	
Emitter-Base Cutoff Current (V _{EB} = -6.0 V, I _C = 0)	LMUN5111DW1T1G	I _{EBO}	–	–	-0.5	mAdc
	LMUN5112DW1T1G		–	–	-0.2	
	LMUN5113DW1T1G		–	–	-0.1	
	LMUN5114DW1T1G		–	–	-0.2	
	LMUN5115DW1T1G		–	–	-0.9	
	LMUN5116DW1T1G		–	–	-1.9	
	LMUN5130DW1T1G		–	–	-4.3	
	LMUN5131DW1T1G		–	–	-2.3	
	LMUN5132DW1T1G		–	–	-1.5	
	LMUN5133DW1T1G		–	–	-0.18	
	LMUN5134DW1T1G		–	–	-0.13	
	LMUN5135DW1T1G		–	–	-0.2	
LMUN5136DW1T1G		–	–	-0.05		
LMUN5137DW1T1G		–	–	-0.13		
Collector-Base Breakdown Voltage (I _C = -10 μA, I _E = 0)	V _{(BR)CBO}	-50	–	–	Vdc	
Collector-Emitter Breakdown Voltage(Note 4.)(I _C = -2.0 mA, I _B = 0)	V _{(BR)CEO}	-50	–	–	Vdc	

ON CHARACTERISTICS (Note 4.)

Collector-Emitter Saturation Voltage (I _C = -10mA, I _E = -0.3 mA)	V _{CE(sat)}	–	–	-0.25	Vdc
(I _C = -10mA, I _B = -5mA)	LMUN5130DW1T1G/LMUN5131DW1T1G				
(I _C = -10mA, I _B = -1mA)	LMUN5115DW1T1/LMUN5116DW1T1G				
	LMUN5132DW1T1G/LMUN5133DW1T1G/LMUN5134DW1T1G				

3. New resistor combinations. Updated curves to follow in subsequent data sheets.

4. Pulse Test: Pulse Width < 300 μs, Duty Cycle < 2.0%

LMUN5111DW1T1G Series

ELECTRICAL CHARACTERISTICS

(T_A = 25°C unless otherwise noted, common for Q₁ and Q₂,) (Continued)

Characteristic	Symbol	Min	Typ	Max	Unit	
ON CHARACTERISTICS (Note 5.)						
DC Current Gain (V _{CE} = -10 V, I _C = -5.0 mA)	LMUN5111DW1T1G	h _{FE}	35	60	-	
	LMUN5112DW1T1G		60	100	-	
	LMUN5113DW1T1G		80	140	-	
	LMUN5114DW1T1G		80	140	-	
	LMUN5115DW1T1G		160	250	-	
	LMUN5116DW1T1G		160	250	-	
	LMUN5130DW1T1G		3.0	5.0	-	
	LMUN5131DW1T1G		8.0	15	-	
	LMUN5132DW1T1G		15	27	-	
	LMUN5133DW1T1G		80	140	-	
	LMUN5134DW1T1G		80	130	-	
	LMUN5135DW1T1G		80	140	-	
	LMUN5136DW1T1G		80	130	-	
	LMUN5137DW1T1G		80	140	-	
Output Voltage (on) (V _{CC} = -5.0 V, V _B = -2.5 V, R _L = 1.0 kΩ)	LMUN5111DW1T1G	V _{OL}	-	-	-0.2	
	LMUN5112DW1T1G		-	-	-0.2	
	LMUN5114DW1T1G		-	-	-0.2	
	LMUN5115DW1T1G		-	-	-0.2	
	LMUN5116DW1T1G		-	-	-0.2	
	LMUN5130DW1T1G		-	-	-0.2	
	LMUN5131DW1T1G		-	-	-0.2	
	LMUN5132DW1T1G		-	-	-0.2	
	LMUN5133DW1T1G		-	-	-0.2	
	LMUN5134DW1T1G		-	-	-0.2	
	LMUN5135DW1T1G		-	-	-0.2	
	(V _{CC} = -5.0 V, V _B = -3.5 V, R _L = 1.0 kΩ)	LMUN5113DW1T1G		-	-	-0.2
	(V _{CC} = -5.0 V, V _B = -5.5 V, R _L = 1.0 kΩ)	LMUN5136DW1T1G		-	-	-0.2
	(V _{CC} = -5.0 V, V _B = -4.0 V, R _L = 1.0 kΩ)	LMUN5137DW1T1G		-	-	-0.2
Output Voltage (off) (V _{CC} = -5.0 V, V _B = -0.5 V, R _L = 1.0 kΩ)	LMUN5130DW1T1G	V _{OH}	-4.9	-	-	
	LMUN5115DW1T1G					
	LMUN5116DW1T1G					
	LMUN5131DW1T1G					
	LMUN5133DW1T1G					

LMUN5111DW1T1G Series

ELECTRICAL CHARACTERISTICS

($T_A = 25^\circ\text{C}$ unless otherwise noted, common for Q_1 and Q_2 .) (Continued)

Characteristic	Symbol	Min	Typ	Max	Unit	
ON CHARACTERISTICS (Note 5.)						
Input Resistor	LMUN5111DW1T1G	R_1	7.0	10	13	$k\Omega$
	LMUN5112DW1T1G		15.4	22	28.6	
	LMUN5113DW1T1G		32.9	47	61.1	
	LMUN5114DW1T1G		7.0	10	13	
	LMUN5115DW1T1G		7.0	10	13	
	LMUN5116DW1T1G		3.3	4.7	6.1	
	LMUN5130DW1T1G		0.7	1.0	1.3	
	LMUN5131DW1T1G		1.5	2.2	2.9	
	LMUN5132DW1T1G		3.3	4.7	6.1	
	LMUN5133DW1T1G		3.3	4.7	6.1	
	LMUN5134DW1T1G		15.4	22	28.6	
	LMUN5135DW1T1G		1.54	2.2	2.86	
	LMUN5136DW1T1G		70	100	130	
	LMUN5137DW1T1G		32.9	47	61.1	
Resistor Ratio	LMUN5111DW1T1G/LMUN5112DW1T1G	R_1/R_2				
	LMUN5113DW1T1G/LMUN5136DW1T1G		0.8	1.0	1.2	
	LMUN5114DW1T1G/LMUN5115DW1T1G		0.17	0.21	0.25	
	LMUN5116DW1T1G/LMUN5130DW1T1G		—	—	—	
	LMUN5131DW1T1G/LMUN5132DW1T1G		0.8	1.0	1.2	
	LMUN5133DW1T1G		0.055	0.1	0.185	
	LMUN5134DW1T1G		0.38	0.47	0.56	
	LMUN5135DW1T1G		0.038	0.047	0.056	
LMUN5137DW1T1G		1.7	2.1	2.6		

5. Pulse Test: Pulse Width < 300 ms, Duty Cycle < 2.0%

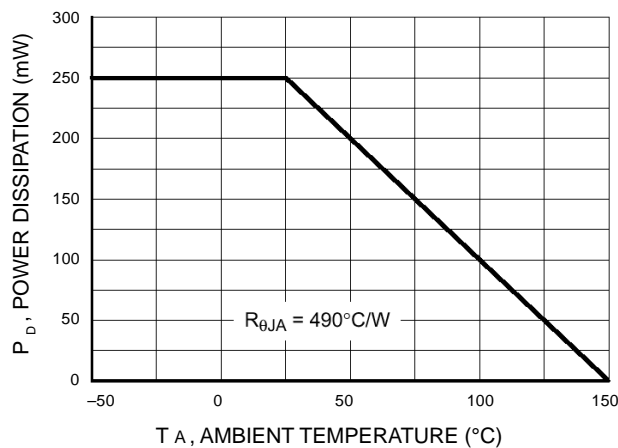

Figure 1. Derating Curve

LMUN5111DW1T1G Series

TYPICAL ELECTRICAL CHARACTERISTICS – LMUN5111DW1T1G

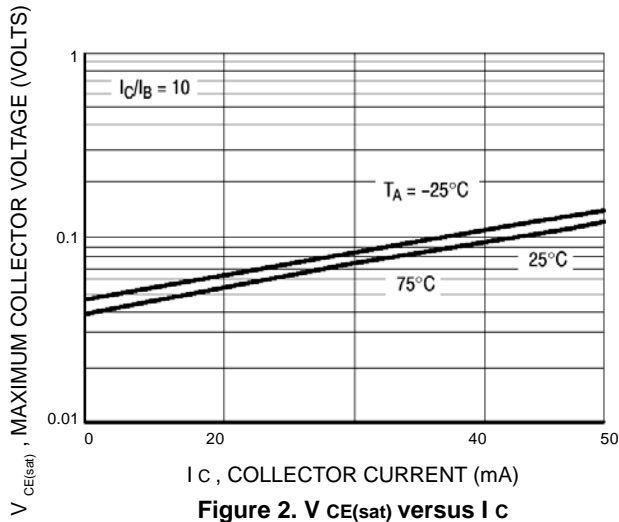

Figure 2. $V_{CE(sat)}$ versus I_C

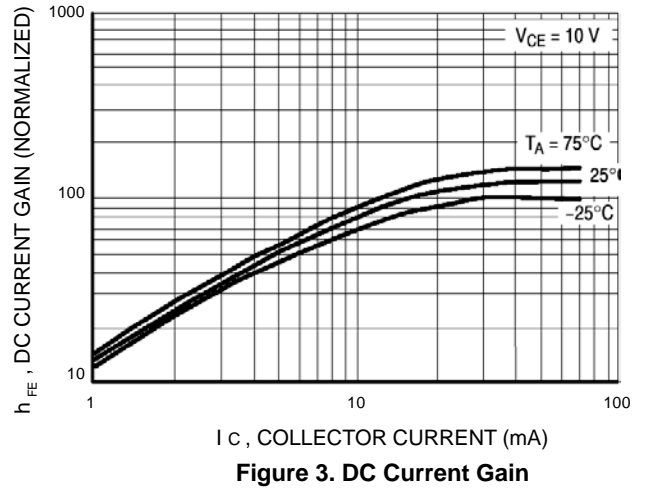

Figure 3. DC Current Gain

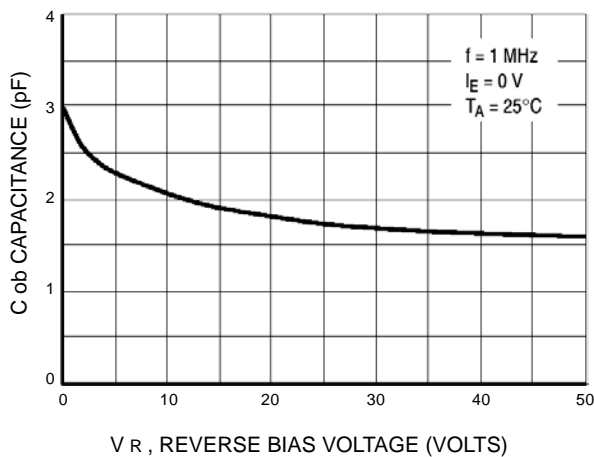

Figure 4. Output Capacitance

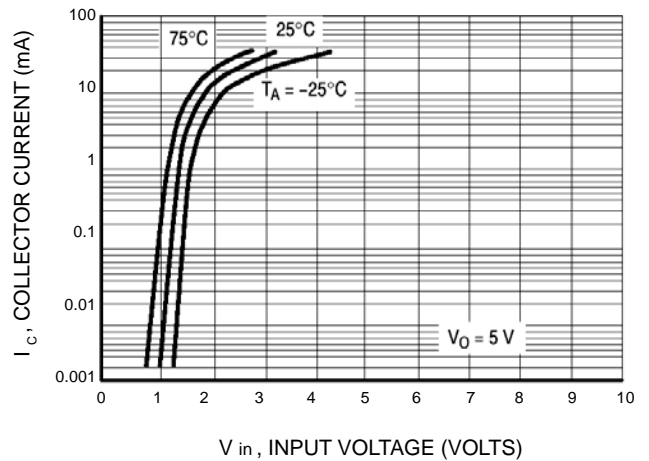

Figure 5. Output Current versus Input Voltage

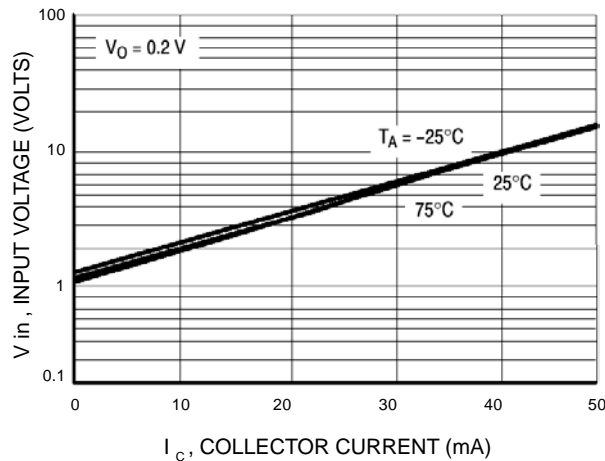

Figure 6. Input Voltage versus Output Current

LMUN5111DW1T1G Series

TYPICAL ELECTRICAL CHARACTERISTICS – LMUN5112DW1T1G

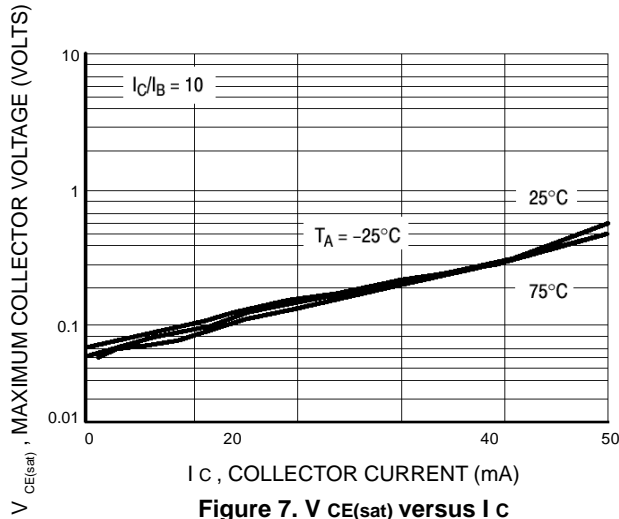

Figure 7. $V_{CE(sat)}$ versus I_C

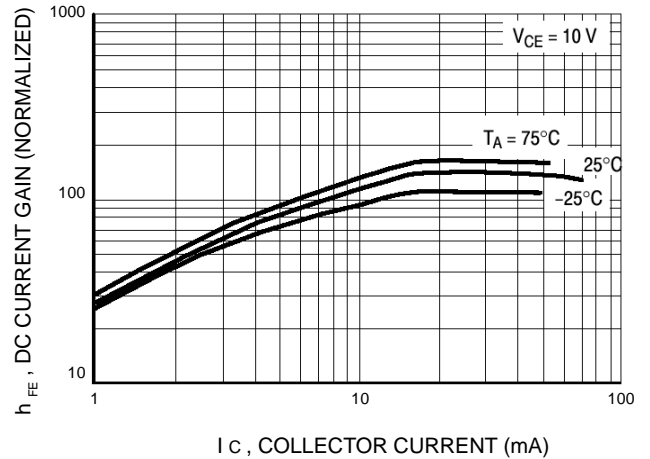

Figure 8. DC Current Gain

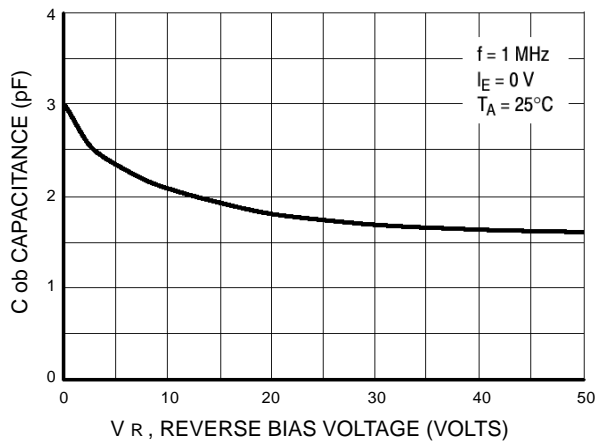

Figure 9. Output Capacitance

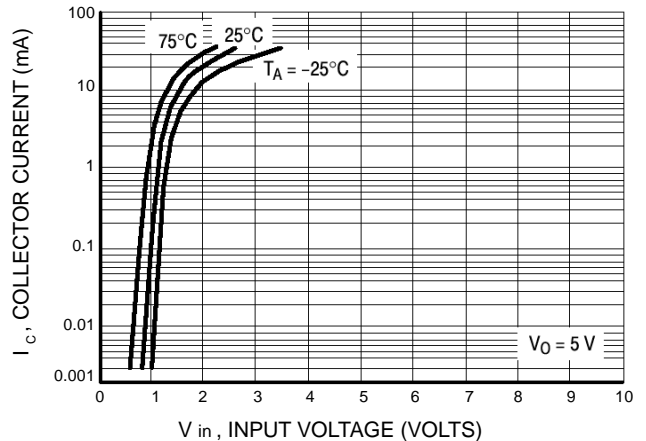

Figure 10. Output Current versus Input voltage

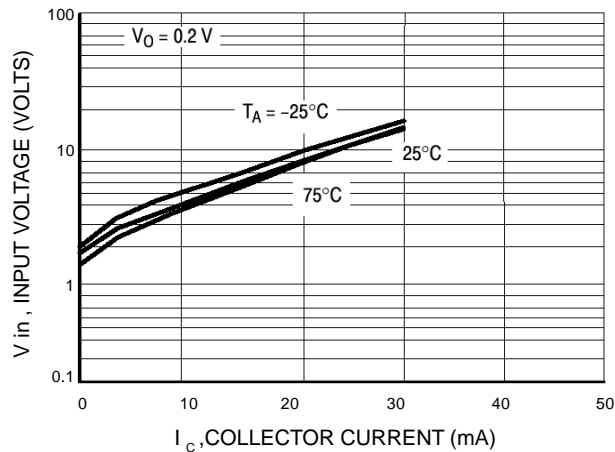

Figure 11. Input Voltage versus Output Current

LMUN5111DW1T1G Series

TYPICAL ELECTRICAL CHARACTERISTICS – LMUN5113DW1T1G

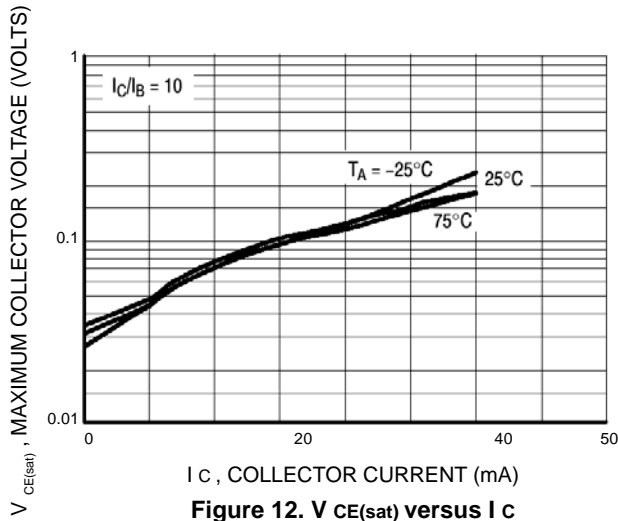

Figure 12. $V_{CE(sat)}$ versus I_C

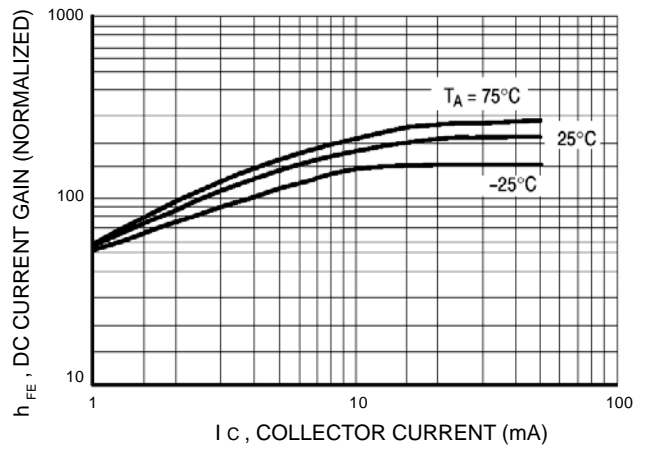

Figure 13. DC Current Gain

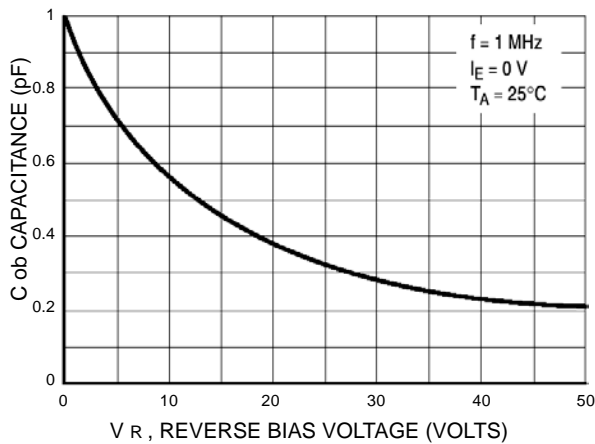

Figure 14. Output Capacitance

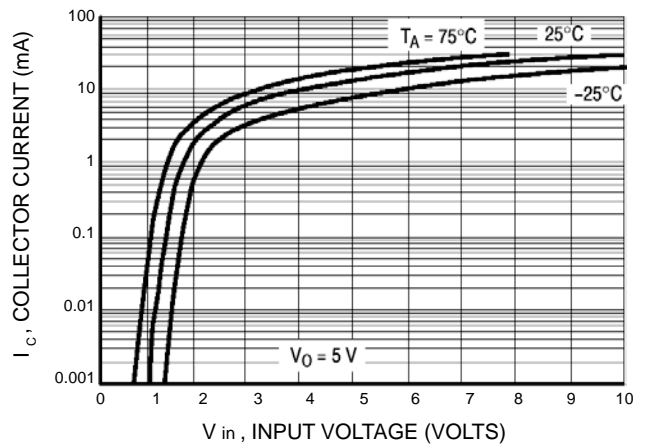

Figure 15. Output Current versus Input Voltage

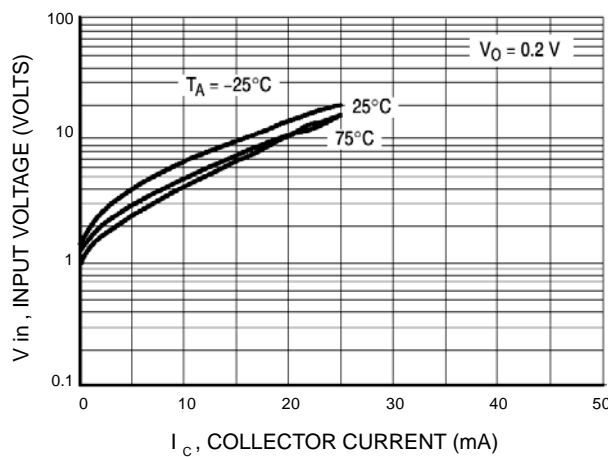

Figure 16. Input Voltage versus Output Current

LMUN5111DW1T1G Series

TYPICAL ELECTRICAL CHARACTERISTICS – LMUN5114DW1T1G

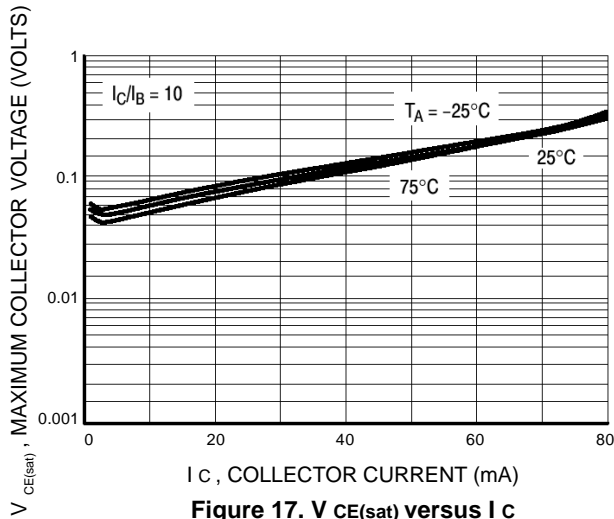

Figure 17. $V_{CE(sat)}$ versus I_C

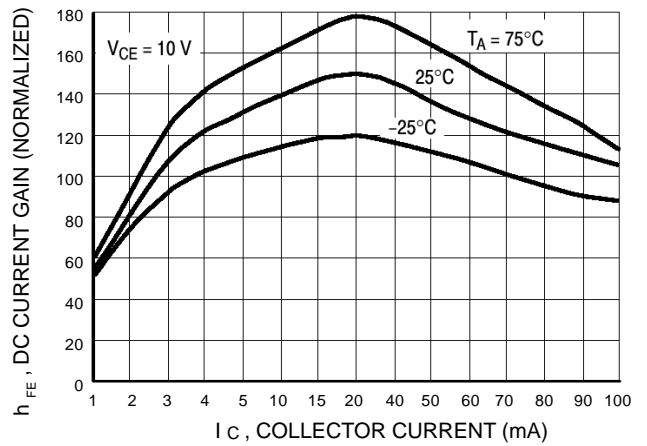

Figure 18. DC Current Gain

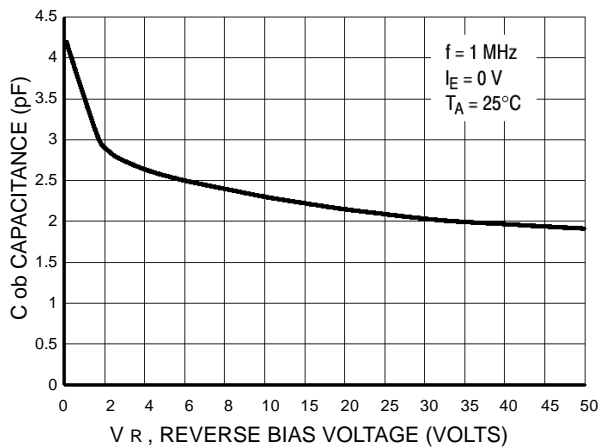

Figure 19. Output Capacitance

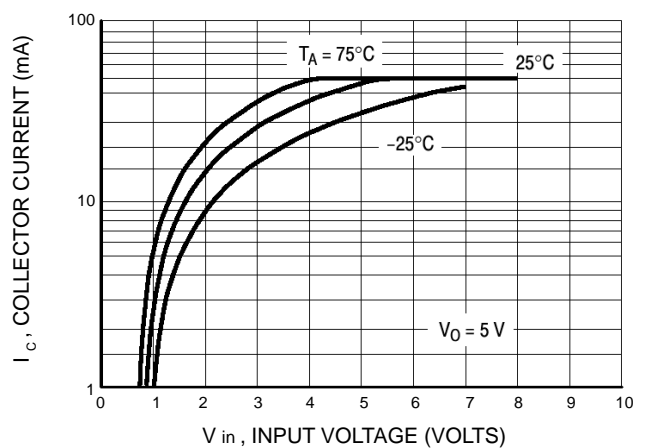

Figure 20. Output Current versus Input Voltage

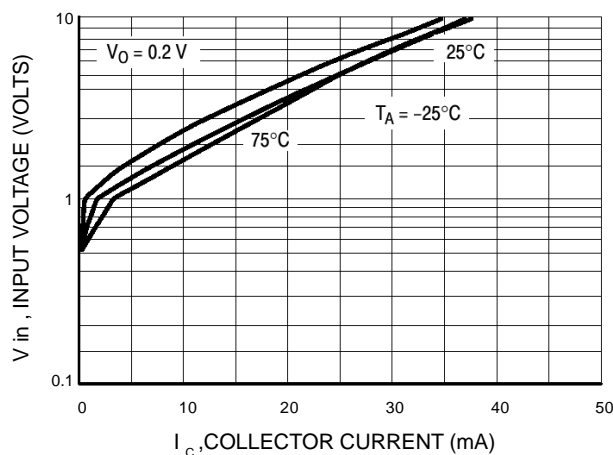
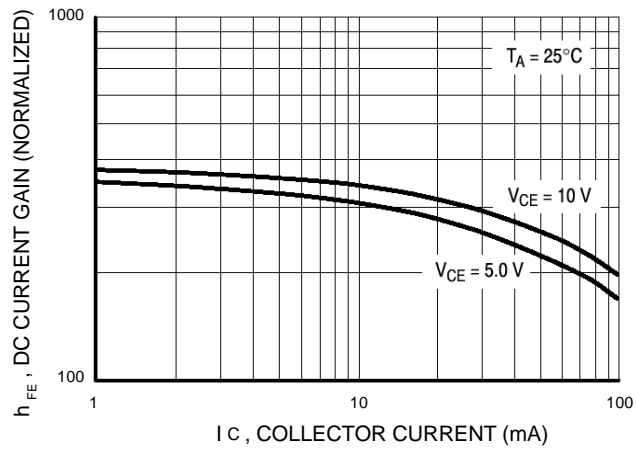
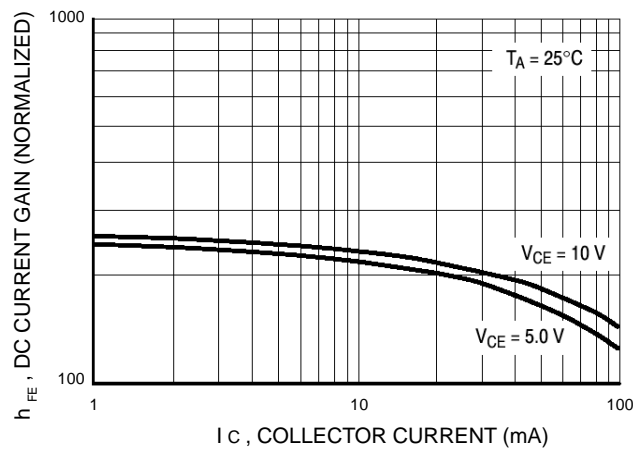

Figure 21. Input Voltage versus Output Current

LMUN5111DW1T1G Series
TYPICAL ELECTRICAL CHARACTERISTICS – LMUN5115DW1T1G

Figure 22. DC Current Gain
TYPICAL ELECTRICAL CHARACTERISTICS – LMUN5116DW1T1

Figure 23. DC Current Gain

LMUN5111DW1T1G Series

TYPICAL ELECTRICAL CHARACTERISTICS – LMUN5136DW1T1G

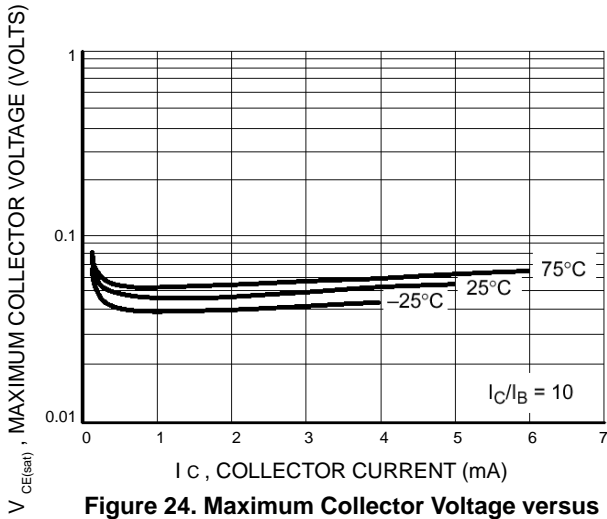

Figure 24. Maximum Collector Voltage versus Collector Current

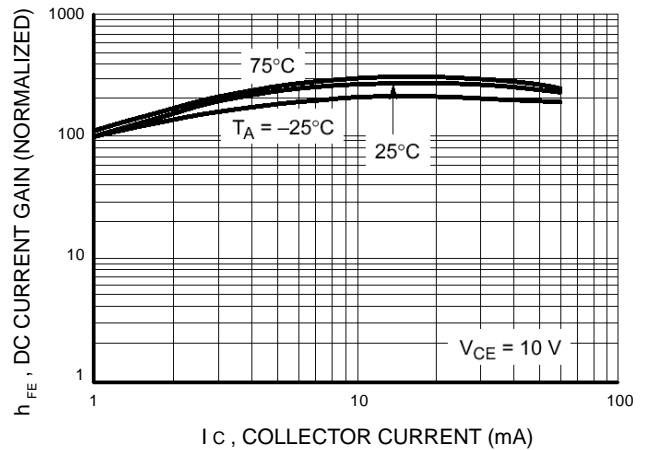

Figure 25. DC Current Gain

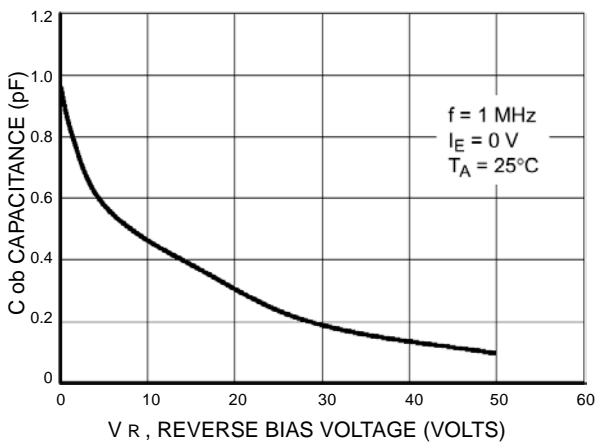

Figure 26. Output Capacitance

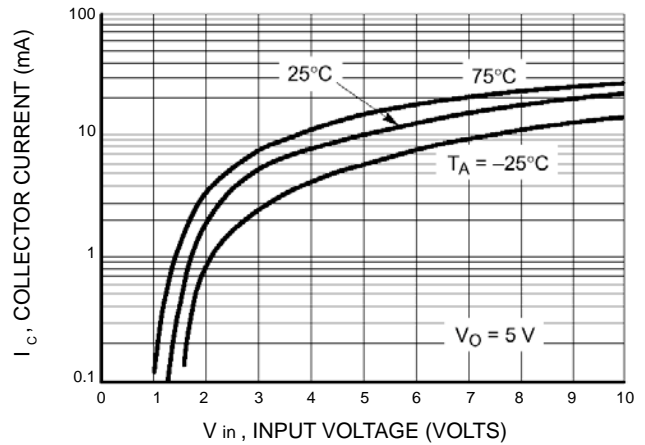

Figure 27. Output Current versus Input Voltage

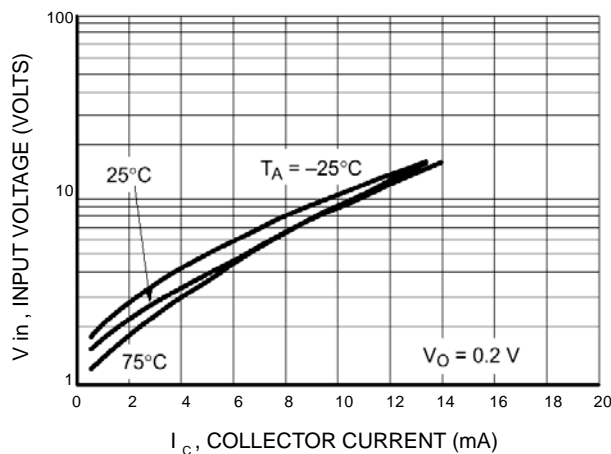

Figure 28. Input Voltage versus Output Current

LMUN5111DW1T1G Series

TYPICAL ELECTRICAL CHARACTERISTICS – LMUN5137DW1T1G

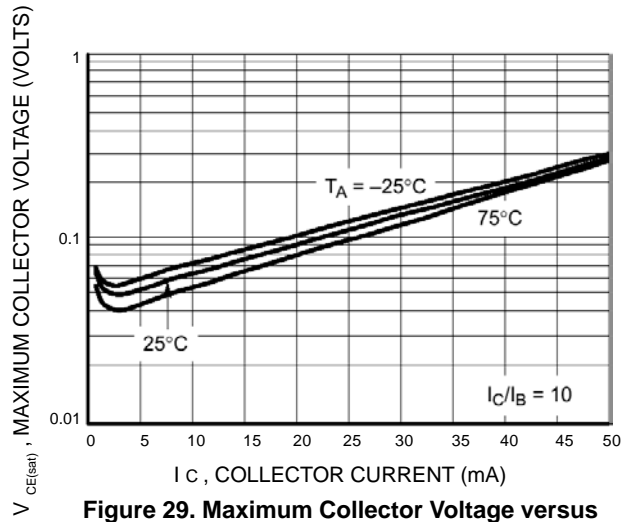

Figure 29. Maximum Collector Voltage versus Collector Current

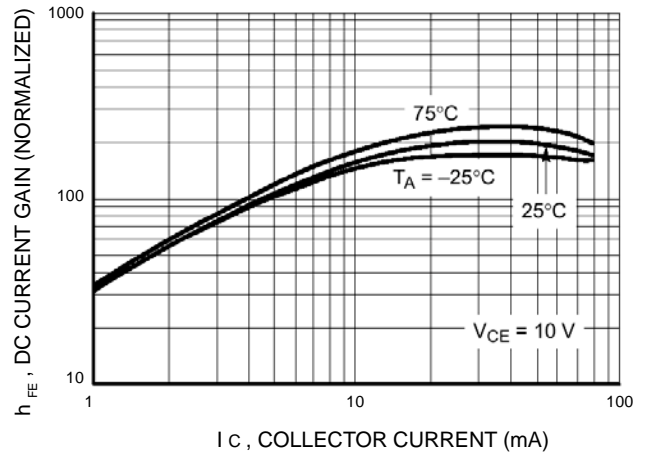

Figure 30. DC Current Gain

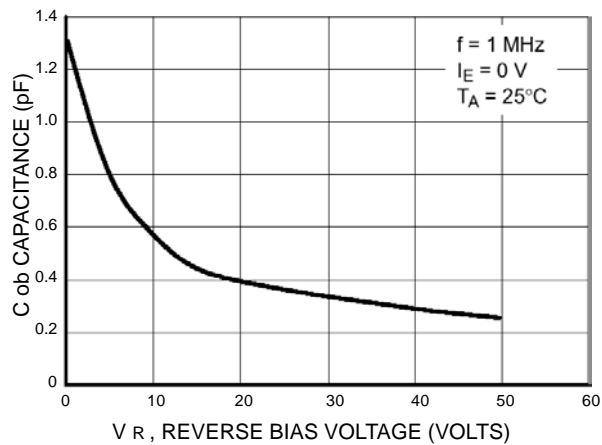

Figure 31. Output Capacitance

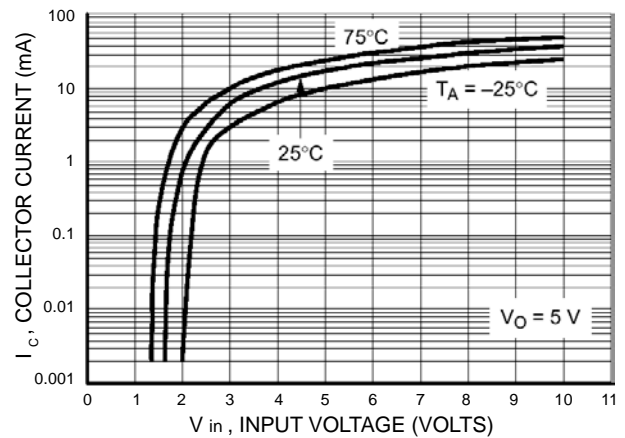

Figure 32. Output Current versus Input Voltage

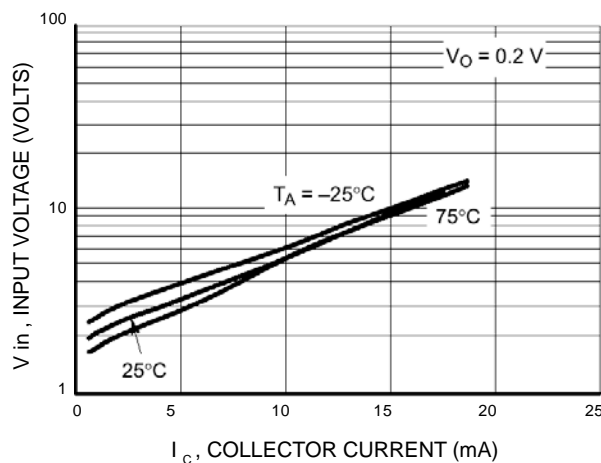
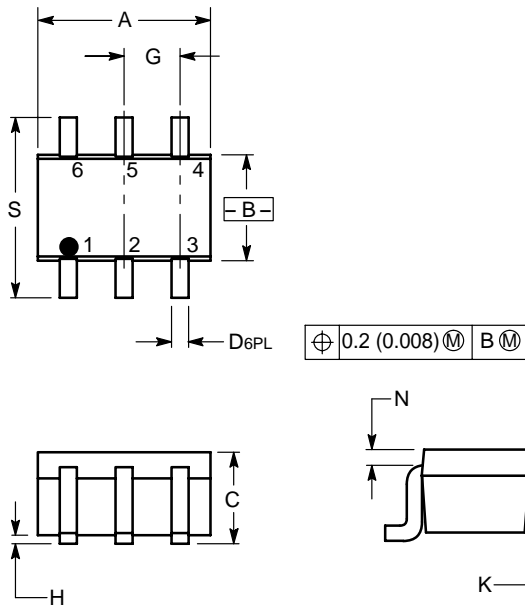

Figure 33. Input Voltage versus Output Current

LMUN5111DW1T1G Series

SC-88/SOT-363



NOTES:

1. DIMENSIONING AND TOLERANCING PER ANSI Y14.5M, 1982.
2. CONTROLLING DIMENSION: INCH.

DIM	INCHES		MILLIMETERS	
	MIN	MAX	MIN	MAX
A	0.071	0.087	1.80	2.20
B	0.045	0.053	1.15	1.35
C	0.031	0.043	0.80	1.10
D	0.004	0.012	0.10	0.30
G	0.026 BSC		0.65 BSC	
H	---	0.004	---	0.10
J	0.004	0.010	0.10	0.25
K	0.004	0.012	0.10	0.30
N	0.008 REF		0.20 REF	
S	0.079	0.087	2.00	2.20

- PIN 1. EMITTER 2
 2. BASE 2
 3. COLLECTOR 1
 4. EMITTER 1
 5. BASE 1
 6. COLLECTOR 2

