



SBL10xxCT, SBLF10xxCT & SBLB10xxCT Series

Schottky Barrier Rectifiers

Reverse Voltage 30 to 40 Volts Forward Current 10.0 Amperes

Features

- ◆ Plastic package has Underwriters Laboratory Flammability Classification 94V-0
- ◆ Dual rectifier construction, positive center tap
- ◆ Metal silicon junction, majority carrier conduction
- ◆ Low power loss, high efficiency
- ◆ Guardring for overvoltage protection
- ◆ For use in low voltage, high frequency inverters, free wheeling, and polarity protection applications

Mechanical Data

- ◆ Case: JEDEC TO-220AB, ITO-220AB & TO-263AB molded plastic body
- ◆ Terminals: Plated leads, solderable per MIL-STD-750, Method 2026
- ◆ High temperature soldering guaranteed: 250°C/10 seconds, 0.25" (6.35mm) from case
- ◆ Polarity: As marked
- ◆ Mounting Position: Any
- ◆ Mounting Torque: 10 in-lbs maximum
- ◆ Weight: 0.08 ounce, 2.24 grams

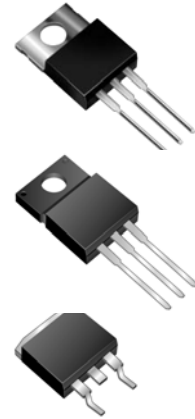

TO-220AB

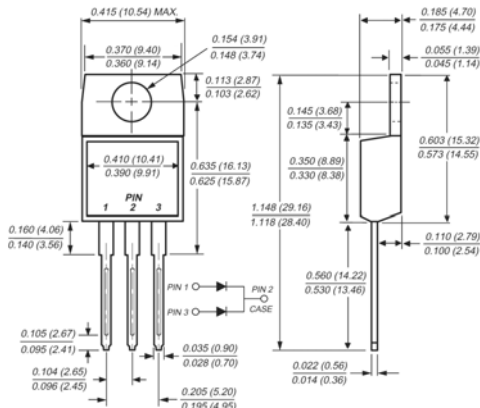

Mounting Pad Layout TO-263AB

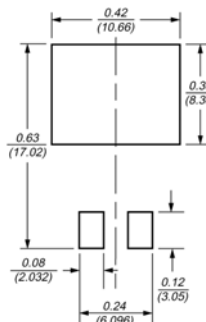

ITO-220AB

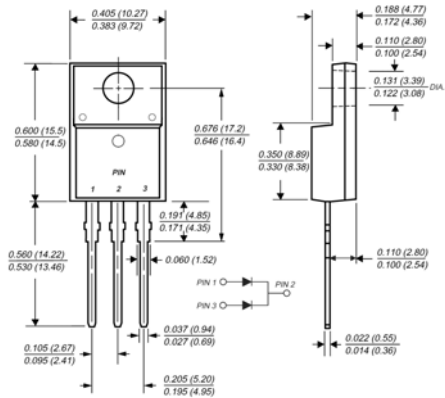

TO-263AB(D²PAK)

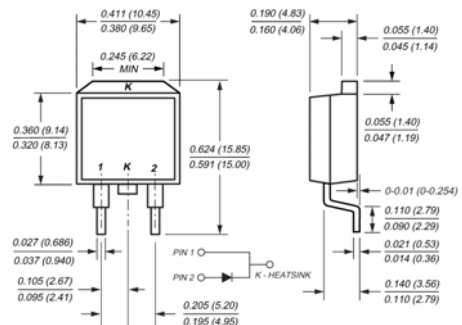

Dimensions in inches and (millimeters)

Maximum Ratings and Electrical Characteristics

($T_c = 25^\circ\text{C}$ unless otherwise noted)

Parameter	Symbol	SBL1030CT	SBL1040CT	Unit
Maximum repetitive peak reverse voltage	V_{RRM}	30	40	Volts
Working peak reverse voltage	V_{RWM}	30	40	Volts
Maximum DC blocking voltage	V_{DC}	30	40	Volts
Maximum average forward rectified current at $T_c=107^\circ\text{C}$	Total device Per leg $I_{F(AV)}$	10 5.0		Amps
Peak forward surge current 8.3ms single half sine-wave superimposed on rated load (JEDEC Method) per leg	I_{FSM}		175	Amps
Maximum instantaneous forward voltage per leg at 5.0A (Note 4)	V_F		0.55	Volts
Maximum instantaneous reverse current per leg at rated DC blocking voltage (Note 4)	I_R		0.5 50	mA
Typical thermal resistance per leg	$R_{\theta JC}$	SBL 3.0 / SBLF 5.0 / SBLB 3.0		$^\circ\text{C/W}$
RMS Isolation voltage (SBLF type only) from terminals to heatsink with $t = 1.0$ second, $RH \leq 30\%$	V_{ISOL}	4500 (Note 1) 3500 (Note 2) 1500 (Note 3)		Volts
Operating junction temperature range	T_J	-55 to +125		$^\circ\text{C}$
Storage temperature range	T_{STG}	-55 to +150		$^\circ\text{C}$

- Notes:**
1. Clip mounting (on case), where lead does not overlap heatsink with 0.110" offset
 2. Clip mounting (on case), where leads do overlap heatsink
 3. Screw mounting with 4-40 screw, where washer diameter is < 4.9 mm (0.19")
 4. Pulse test: 300us pulse width, 1% duty cycle

RATINGS AND CHARACTERISTIC CURVES

($T_A = 25^\circ\text{C}$ unless otherwise noted)

Fig. 1 - Forward Current Derating Curve

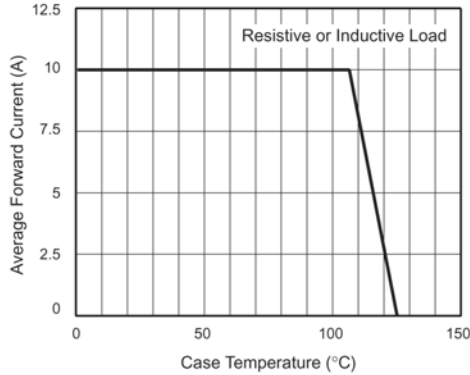

Fig. 2 - Maximum Non-Repetitive Peak Forward Surge Current Per Leg

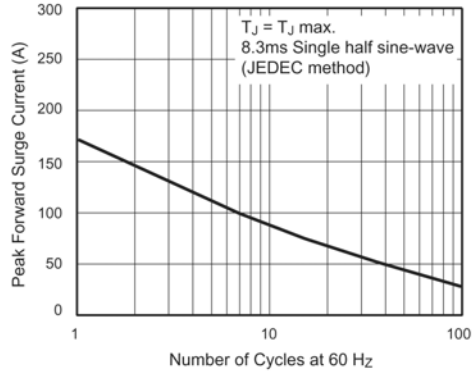

Fig. 3 - Typical Instantaneous Forward Characteristics Per Leg

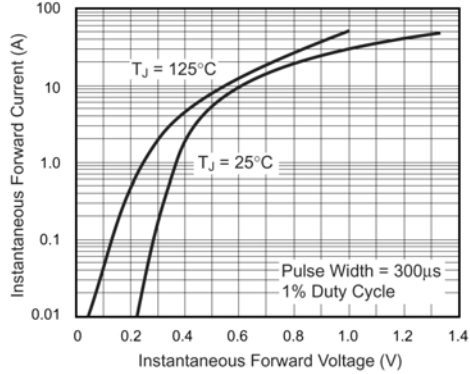

Fig. 4 - Typical Reverse Characteristics Per Leg

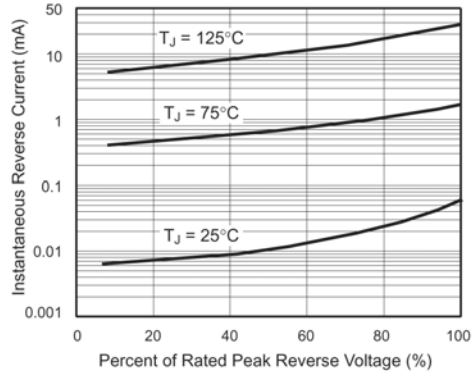

Fig. 5 - Typical Junction Capacitance Per Leg

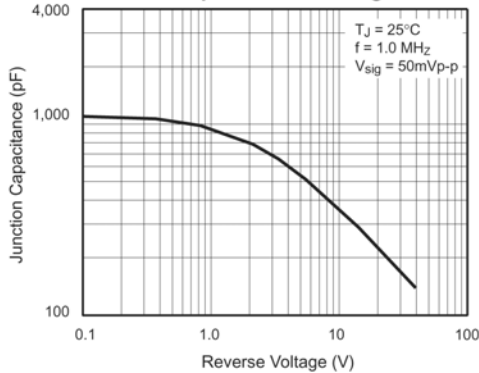

Fig. 6 - Typical Transient Thermal Impedance Per Leg

