

Pressfit Rectifier Diodes, 50 A



B-47

FEATURES

- Convenient pressfit package
- Available with and without leads
- High surge capabilities
- Fully characterized bulletin
- RoHS compliant
- Designed and qualified for industrial level

RoHS
COMPLIANT

PRODUCT SUMMARY

$I_{F(AV)}$	50 A
-------------	------

MAJOR RATINGS AND CHARACTERISTICS

PARAMETER	TEST CONDITIONS	VALUES	UNITS
$I_{F(AV)}$		50	A
	T_C	150	°C
$I_{F(RMS)}$		79	A
I_{FSM}	50 Hz	714	A
	60 Hz	747	
I^2t	50 Hz	2546	A ² s
	60 Hz	2324	
$I^2\sqrt{t}$		25 455	A ² √s
V_{RRM}	Range	50 to 400	V
T_J		- 65 to 195	°C

ELECTRICAL SPECIFICATIONS

VOLTAGE RATINGS

TYPE NUMBER	VOLTAGE CODE	V_{RRM} , MAXIMUM REPETITIVE PEAK REVERSE VOLTAGE V	V_{RSM} , MAXIMUM NON-REPETITIVE PEAK REVERSE VOLTAGE V	I_{RRM} MAXIMUM AT $T_J = T_J$ MAXIMUM mA
8AF	05	50	75	7
	1	100	150	7
	2	200	300	5
	4	400	500	5

FORWARD CONDUCTION					
PARAMETER	SYMBOL	TEST CONDITIONS		VALUES	UNITS
Maximum average forward current at case temperature	$I_{F(AV)}$	180° conduction, half sine wave		50	A
				150	°C
Maximum RMS forward current	$I_{F(RMS)}$			79	A
Maximum peak, one cycle forward, non-repetitive surge current	I_{FSM}	t = 10 ms	No voltage reappplied	Sinusoidal half wave, initial $T_J = T_J$ maximum	A
		t = 8.3 ms			
		t = 10 ms	100 % V_{RRM} reappplied		
		t = 8.3 ms			
Maximum I^2t for fusing	I^2t	t = 10 ms	No voltage reappplied		A ² s
		t = 8.3 ms			
		t = 10 ms	100 % V_{RRM} reappplied		
		t = 8.3 ms			
Maximum $I^2\sqrt{t}$ for fusing	$I^2\sqrt{t}$	t = 0.1 to 10 ms, no voltage reappplied		25 455	A ² /s
Low level value of threshold voltage	$V_{F(TO)1}$	$(16.7 \% \times \pi \times I_{F(AV)} < I < \pi \times I_{F(AV)})$, $T_J = T_J$ maximum		0.60	V
High level value of threshold voltage	$V_{F(TO)2}$	$(\pi \times I_{F(AV)} < I < 20 \times \pi \times I_{F(AV)})$, $T_J = T_J$ maximum		0.68	
Low level value of forward slope resistance	r_{f1}	$(16.7 \% \times \pi \times I_{F(AV)} < I < \pi \times I_{F(AV)})$, $T_J = T_J$ maximum		6.66	mΩ
High level value of forward slope resistance	r_{f2}	$(\pi \times I_{F(AV)} < I < 20 \times \pi \times I_{F(AV)})$, $T_J = T_J$ maximum		6.25	
Maximum forward voltage drop	V_{FM}	$T_J = 25\text{ °C}$, $I_{FM} = \pi \times$ rated $I_{F(AV)}$		1.45	V

THERMAL AND MECHANICAL SPECIFICATIONS				
PARAMETER	SYMBOL	TEST CONDITIONS	VALUES	UNITS
Maximum junction operating and storage temperature range	T_J, T_{Stg}		- 65 to 195	°C
Maximum thermal resistance, junction to case	R_{thJC}	DC operation	0.60	K/W
Typical thermal resistance, case to heatsink	R_{thCS}	As per mounting details, see note ⁽¹⁾	0.50	
Approximate weight			10	g
			0.36	oz.
Case style		See dimensions - link at the end of datasheet	B-47	

Note

⁽¹⁾ Mounting: A 12.6 ± 0.02 mm (0.496 to 0.497") diameter hole should be drilled in heatsink, the leading edge chamfered to 0.038 mm (0.015") x 45°. The autodiode should then be press fitted, ensuring that the sides of the autodiode are kept parallel to the sides of the hole.

ΔR_{thJC} CONDUCTION				
CONDUCTION ANGLE	SINUSOIDAL CONDUCTION	RECTANGULAR CONDUCTION	TEST CONDITIONS	UNITS
180°	0.042	0.026	$T_J = T_{J \text{ maximum}}$	K/W
120°	0.045	0.043		
90°	0.06	0.06		
60°	0.10	0.10		
30°	0.15	0.15		

Note

- The table above shows the increment of thermal resistance R_{thJC} when devices operate at different conduction angles than DC

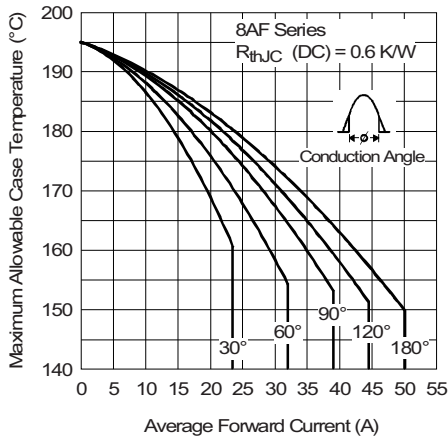

Fig. 1 - Current Ratings Characteristics

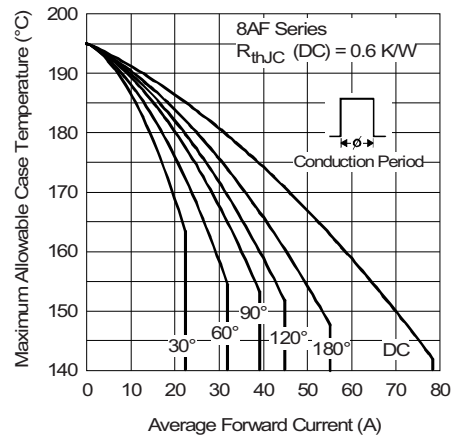

Fig. 2 - Current Ratings Characteristics

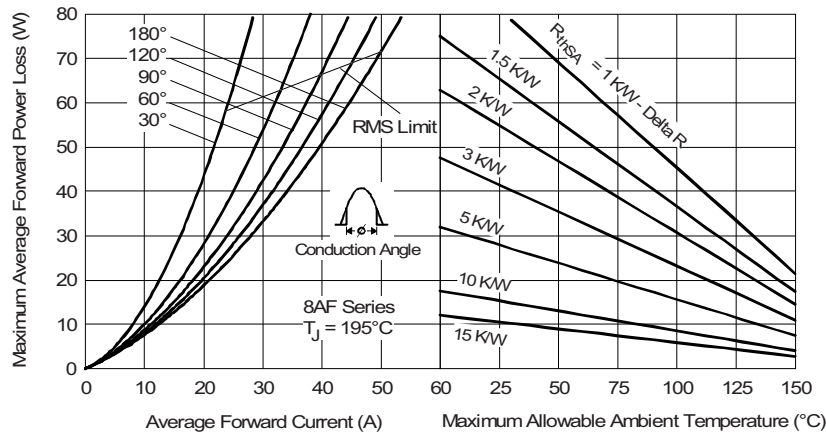

Fig. 3 - Forward Power Loss Characteristics

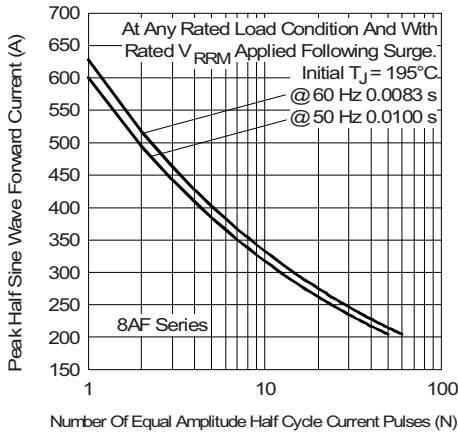
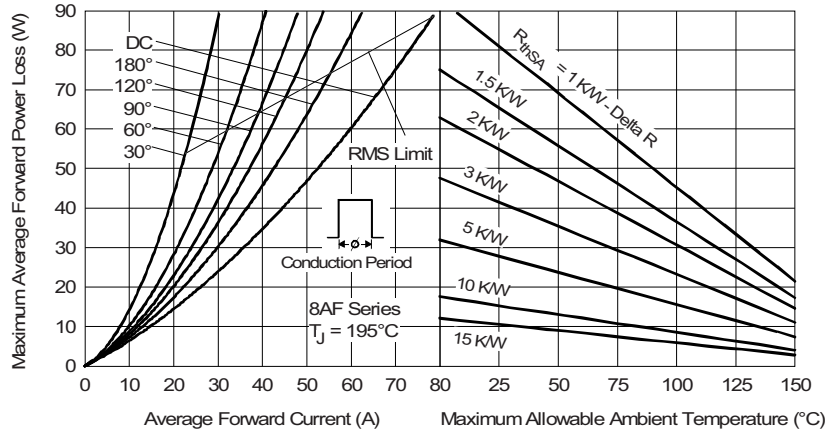

Fig. 5 - Maximum Non-Repetitive Surge Current

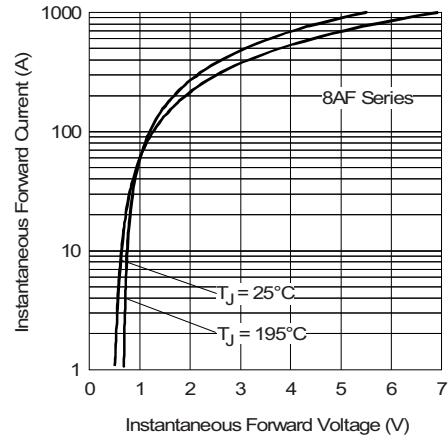

Fig. 7 - Forward Voltage Drop Characteristics

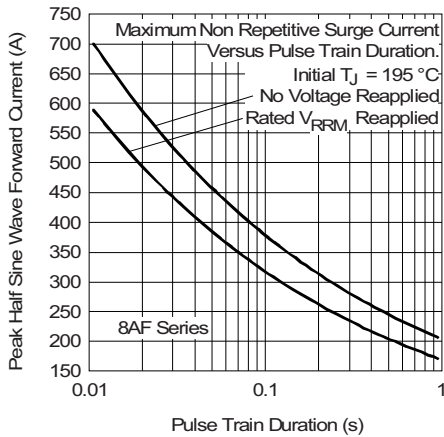

Fig. 6 - Maximum Non-Repetitive Surge Current

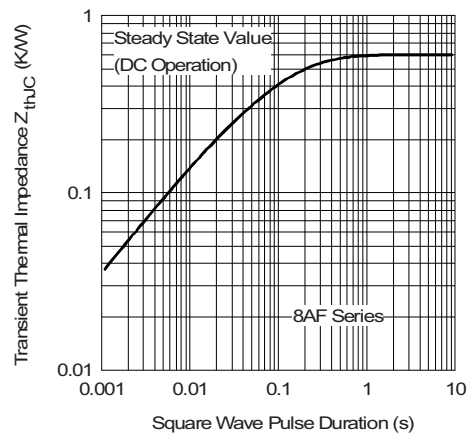
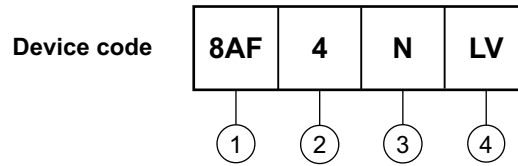

Fig. 8 - Thermal Impedance Z_{thJC} Characteristics



ORDERING INFORMATION TABLE



- 1** - Essential part number
- 2** - Voltage code x 100 = V_{RRM} (see Voltage Ratings table)
- 3** -
 - N = Normal polarity (cathode to case)
 - R = Reverse polarity (anode to case)
- 4** -
 - PP = Without lead
 - LH = Horizontal lead
 - LV = Vertical lead

LINKS TO RELATED DOCUMENTS	
Dimensions	http://www.vishay.com/doc?95330

B-47

DIMENSIONS in millimeters (inches)

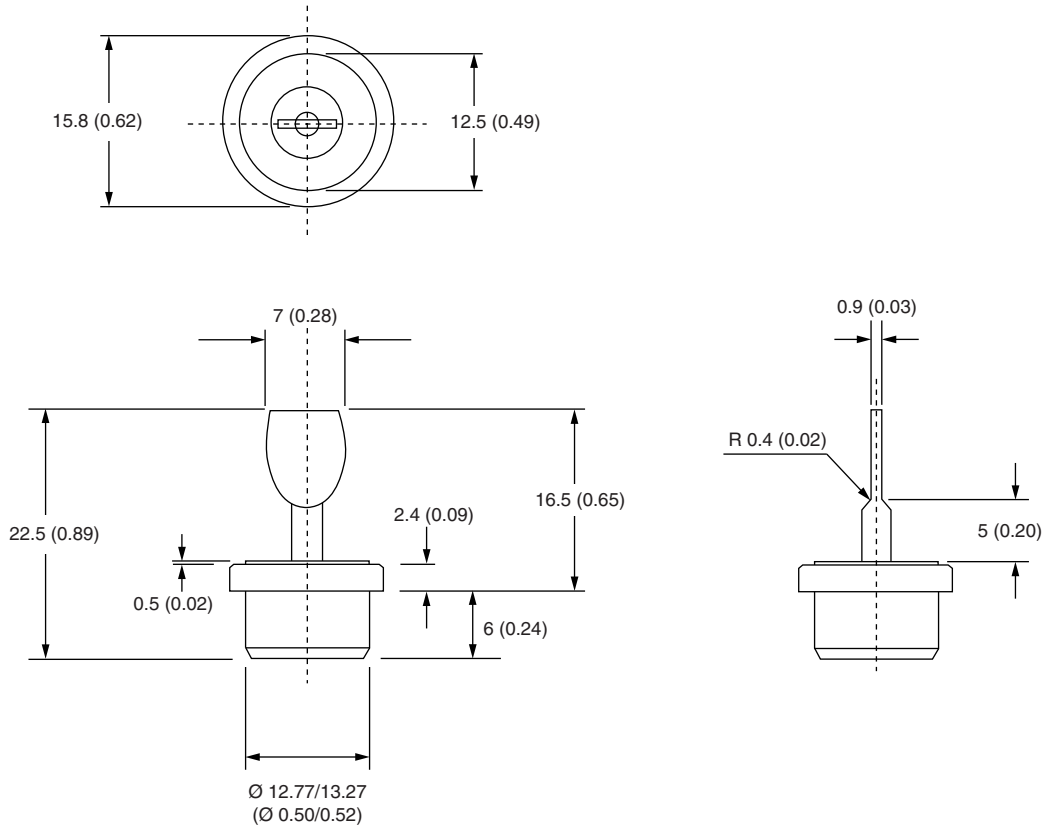



Disclaimer

ALL PRODUCT, PRODUCT SPECIFICATIONS AND DATA ARE SUBJECT TO CHANGE WITHOUT NOTICE TO IMPROVE RELIABILITY, FUNCTION OR DESIGN OR OTHERWISE.

Vishay Intertechnology, Inc., its affiliates, agents, and employees, and all persons acting on its or their behalf (collectively, "Vishay"), disclaim any and all liability for any errors, inaccuracies or incompleteness contained in any datasheet or in any other disclosure relating to any product.

Vishay makes no warranty, representation or guarantee regarding the suitability of the products for any particular purpose or the continuing production of any product. To the maximum extent permitted by applicable law, Vishay disclaims (i) any and all liability arising out of the application or use of any product, (ii) any and all liability, including without limitation special, consequential or incidental damages, and (iii) any and all implied warranties, including warranties of fitness for particular purpose, non-infringement and merchantability.

Statements regarding the suitability of products for certain types of applications are based on Vishay's knowledge of typical requirements that are often placed on Vishay products in generic applications. Such statements are not binding statements about the suitability of products for a particular application. It is the customer's responsibility to validate that a particular product with the properties described in the product specification is suitable for use in a particular application. Parameters provided in datasheets and/or specifications may vary in different applications and performance may vary over time. All operating parameters, including typical parameters, must be validated for each customer application by the customer's technical experts. Product specifications do not expand or otherwise modify Vishay's terms and conditions of purchase, including but not limited to the warranty expressed therein.

Except as expressly indicated in writing, Vishay products are not designed for use in medical, life-saving, or life-sustaining applications or for any other application in which the failure of the Vishay product could result in personal injury or death. Customers using or selling Vishay products not expressly indicated for use in such applications do so at their own risk. Please contact authorized Vishay personnel to obtain written terms and conditions regarding products designed for such applications.

No license, express or implied, by estoppel or otherwise, to any intellectual property rights is granted by this document or by any conduct of Vishay. Product names and markings noted herein may be trademarks of their respective owners.

Material Category Policy

Vishay Intertechnology, Inc. hereby certifies that all its products that are identified as RoHS-Compliant fulfill the definitions and restrictions defined under Directive 2011/65/EU of The European Parliament and of the Council of June 8, 2011 on the restriction of the use of certain hazardous substances in electrical and electronic equipment (EEE) - recast, unless otherwise specified as non-compliant.

Please note that some Vishay documentation may still make reference to RoHS Directive 2002/95/EC. We confirm that all the products identified as being compliant to Directive 2002/95/EC conform to Directive 2011/65/EU.

Vishay Intertechnology, Inc. hereby certifies that all its products that are identified as Halogen-Free follow Halogen-Free requirements as per JEDEC JS709A standards. Please note that some Vishay documentation may still make reference to the IEC 61249-2-21 definition. We confirm that all the products identified as being compliant to IEC 61249-2-21 conform to JEDEC JS709A standards.