

# 2SC4296

Silicon NPN Triple Diffused Planar Transistor (High Voltage and High Speed Switching Transistor) Application : Switching Regulator and General Purpose

## Absolute maximum ratings (Ta=25°C)

Symbol	Ratings	Unit
V <sub>CB0</sub>	500	V
V <sub>CEO</sub>	400	V
V <sub>EB0</sub>	10	V
I <sub>C</sub>	10(Pulse20)	A
I <sub>B</sub>	4	A
P <sub>C</sub>	75(T <sub>C</sub> =25°C)	W
T <sub>J</sub>	150	°C
T <sub>stg</sub>	-55 to +150	°C

## Electrical Characteristics (Ta=25°C)

Symbol	Conditions	Ratings	Unit
I <sub>CB0</sub>	V <sub>CB</sub> =500V	100max	μA
I <sub>EB0</sub>	V <sub>EB</sub> =10V	100max	μA
V <sub>(BR)CEO</sub>	I <sub>C</sub> =25mA	400min	V
h <sub>FE</sub>	V <sub>CE</sub> =4V, I <sub>C</sub> =6A	10 to 30	
V <sub>CE(sat)</sub>	I <sub>C</sub> =6A, I <sub>B</sub> =1.2A	0.5max	V
V <sub>BE(sat)</sub>	I <sub>C</sub> =6A, I <sub>B</sub> =1.2A	1.3max	V
f <sub>r</sub>	V <sub>CE</sub> =12V, I <sub>E</sub> =-0.7A	10typ	MHz
COB	V <sub>CB</sub> =10V, f=1MHz	85typ	pF

## External Dimensions FM100(TO3PF)

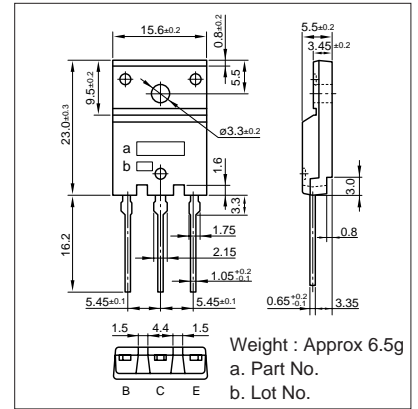

## Typical Switching Characteristics (Common Emitter)

V <sub>CC</sub> (V)	R <sub>L</sub> (Ω)	I <sub>C</sub> (A)	V <sub>BB1</sub> (V)	V <sub>BB2</sub> (V)	I <sub>B1</sub> (A)	I <sub>B2</sub> (A)	t <sub>on</sub> (μs)	t <sub>stg</sub> (μs)	t <sub>f</sub> (μs)
200	33	6	10	-5	0.6	-1.2	1max	3max	0.5max

### I<sub>C</sub>-V<sub>CE</sub> Characteristics (Typical)

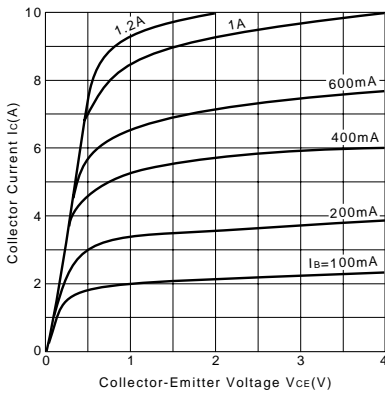

### V<sub>CE(sat)</sub>, V<sub>BE(sat)</sub>-I<sub>C</sub> Temperature Characteristics (Typical)

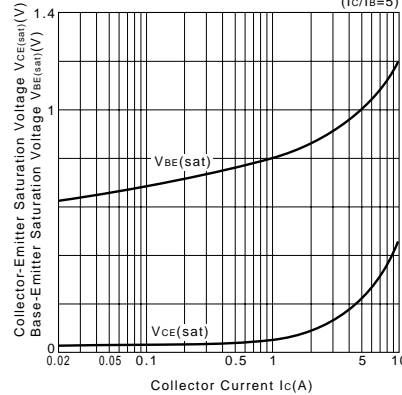

### I<sub>C</sub>-V<sub>BE</sub> Temperature Characteristics (Typical)

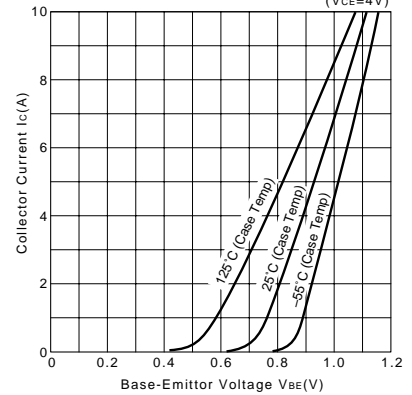

### h<sub>FE</sub>-I<sub>C</sub> Characteristics (Typical)

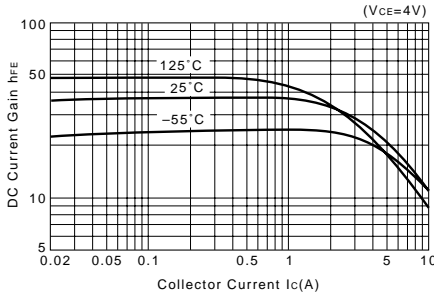

### t<sub>on</sub>\*t<sub>stg</sub>\*t<sub>f</sub>-I<sub>C</sub> Characteristics (Typical)

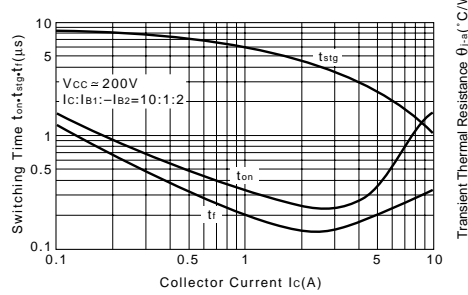

### θ<sub>j-a</sub>-t Characteristics

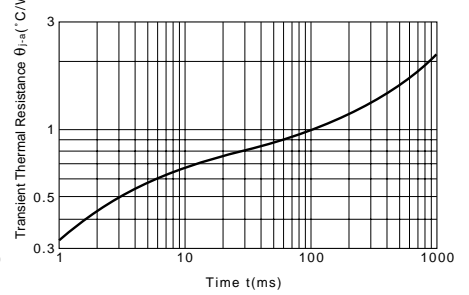

### Safe Operating Area (Single Pulse)

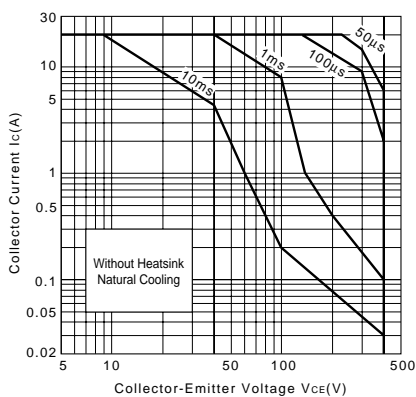

### Reverse Bias Safe Operating Area

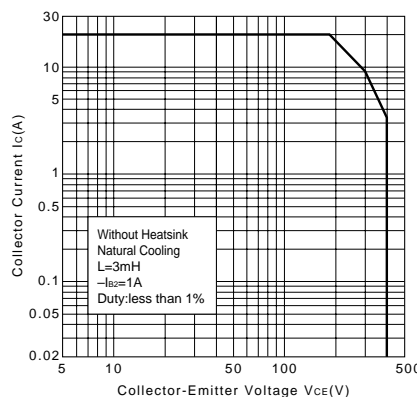

### P<sub>C</sub>-T<sub>a</sub> Derating

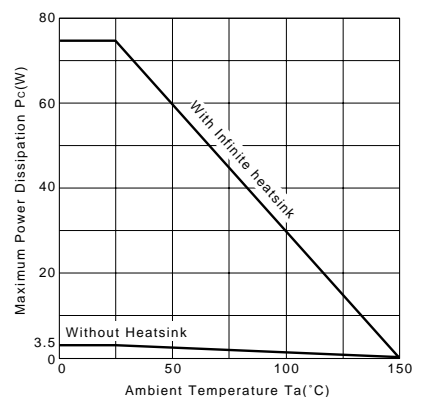

This datasheet has been download from:

[www.datasheetcatalog.com](http://www.datasheetcatalog.com)

Datasheets for electronics components.