

### T10B Series - DO-201



#### Agency Approvals

Agency	Agency File Number
	E128662

#### Pinout Designation

Not Applicable

#### Schematic Symbol



#### Description

T10B Series are SIDACtor® thyristors designed to protect baseband equipment such as modems, line cards, CPE and DSL equipment from damaging overvoltage transients.

This series provides a robust and cost effective through-hole solution that enables equipment to comply with global regulatory standards.

#### Features and Benefits

- Low voltage overshoot
- Low on-state voltage
- Surge capability does not degrade after multiple surges events that are within its limits
- Fails in a short circuit mode when surged beyond its ratings
- High Surge Current Rating
- RoHS Compliant
- Pb-free E3 means 2nd level interconnect is Pb-free and the terminal finish material is tin(Sn) (IPC/JEDEC J-STD-609A.01)

#### Applicable Global Standards

- TIA-968-A
- TIA-968-B
- ITU K.20/21/45 Enhanced Level
- ITU K.20/21/45 Basic Level
- GR 1089 Intra-building
- IEC 61000-4-5, 2nd Edition
- YD/T 1082
- YD/T 993
- YD/T 950
- GR 1089 Inter-building

#### Electrical Characteristics

Part Number	Marking	$V_{DRM}$ @ $I_{DRM}=5\mu A$	$V_S$ @ 100V/ $\mu s$	$I_H$	$I_S$	$I_T$	$V_T$ @ $I_T=2.2$ Amp	Capacitance @ 1MHz, 2V Bias
		V Min	V Max	mA Min	mA Max	A Max	V Max	pF
T10B080Bxx	T10B080B	70	125	120	800	2.2	4	60
T10B110Bxx	T10B110B	100	142	120	800	2.2	4	55
T10B140Bxx	T10B140B	120	178	120	800	2.2	4	48
T10B180Bxx	T10B180B	170	220	120	800	2.2	4	44
T10B220Bxx	T10B220B	200	275	120	800	2.2	4	41
T10B270Bxx	T10B270B	240	370	120	800	2.2	4	36
T10B080Exx	T10B080E	70	125	180	800	2.2	4	60
T10B110Exx	T10B110E	100	142	180	800	2.2	4	55
T10B140Exx	T10B140E	120	178	180	800	2.2	4	48
T10B180Exx	T10B180E	170	220	180	800	2.2	4	44
T10B220Exx	T10B220E	200	275	180	800	2.2	4	41
T10B270Exx	T10B270E	240	370	180	800	2.2	4	36

#### Notes:

- Absolute maximum ratings measured at  $T_A=25^\circ C$  (unless otherwise noted).
- Components are bi-directional.
- **XX** Part Number Suffix: '**RP**' (Reel Pack), '**Blank**' (Bulk Pack), or '**60**' (Type 60 lead form, Bulk Pack)

### Surge Ratings

Series	$I_{PP}$			$I_{TSM}$ 50/60 Hz	di/dt
	8/20 <sup>1</sup> 1.2/50 <sup>2</sup>	5/310 <sup>1</sup> 10/700 <sup>2</sup>	10/1000 <sup>1</sup> 10/1000 <sup>2</sup>		
	A min	A min	A min		
B	250	125	100	30	500

Notes:

- 1 Current waveform in  $\mu s$
  - 2 Voltage waveform in  $\mu s$
- Peak pulse current rating ( $I_{pp}$ ) is repetitive and guaranteed for the life of the product that remains in thermal equilibrium.
  - $I_{pp}$  ratings applicable over temperature range of  $-40^{\circ}C$  to  $+85^{\circ}C$
  - The component must initially be in thermal equilibrium with  $-40^{\circ}C \leq T_j \leq +150^{\circ}C$

### Thermal Considerations

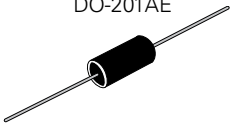
Package	Symbol	Parameter	Value	Unit
 DO-201AE	$T_j$	Operating Junction Temperature Range	-40 to +150	$^{\circ}C$
	$T_s$	Storage Temperature Range	-65 to +150	$^{\circ}C$
	$R_{\theta JA}$	Thermal Resistance: Junction to Ambient	120	$^{\circ}C/W$

### V-I Characteristics

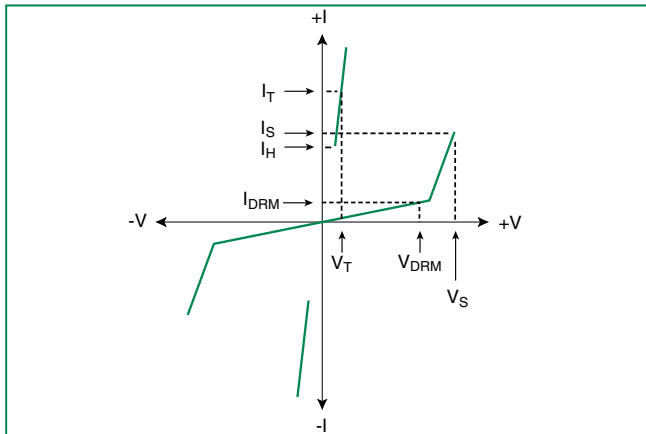

### $t_r \times t_d$ Pulse Waveform

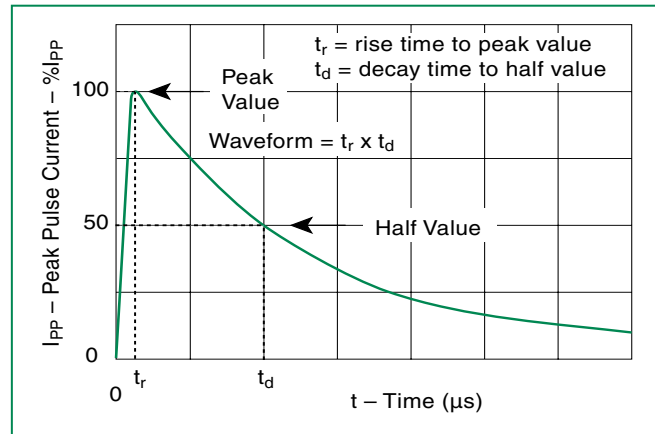

### Normalized $V_S$ Change vs. Junction Temperature

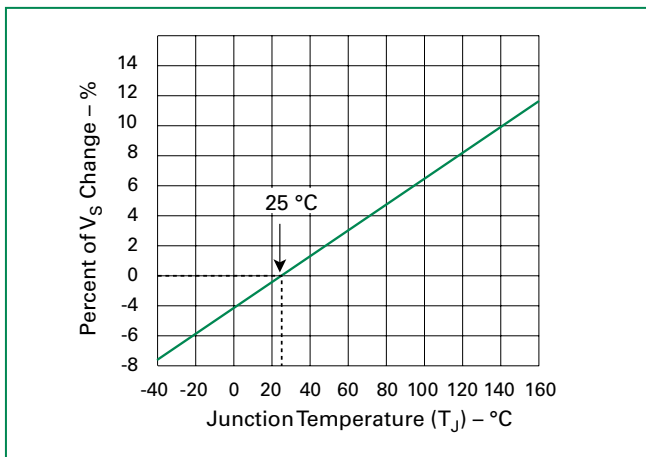

### Normalized DC Holding Current vs. Case Temperature

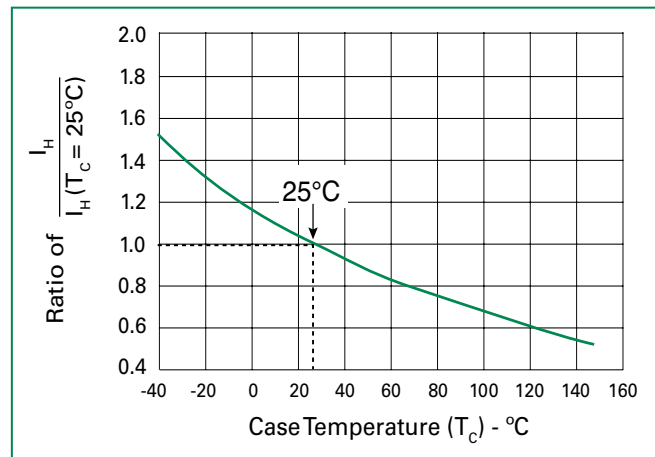

**Soldering Parameters**

Reflow Condition	Pb-Free assembly (see Fig. 1)	
Pre Heat	-Temperature Min ( $T_{s(min)}$ )	+150°C
	-Temperature Max ( $T_{s(max)}$ )	+200°C
	-Time (Min to Max) ( $t_s$ )	60-180 secs.
Average ramp up rate (Liquidus Temp ( $T_L$ ) to peak)	3°C/sec. Max.	
$T_{s(max)}$ to $T_L$ - Ramp-up Rate	3°C/sec. Max.	
Reflow	-Temperature ( $T_L$ ) (Liquidus)	+217°C
	-Temperature ( $t_L$ )	60-150 secs.
Peak Temp ( $T_p$ )	+260(+0/-5)°C	
Time within 5°C of actual Peak Temp ( $t_p$ )	30 secs. Max.	
Ramp-down Rate	6°C/sec. Max.	
Time 25°C to Peak Temp ( $T_p$ )	8 min. Max.	
Do not exceed	+260°C	

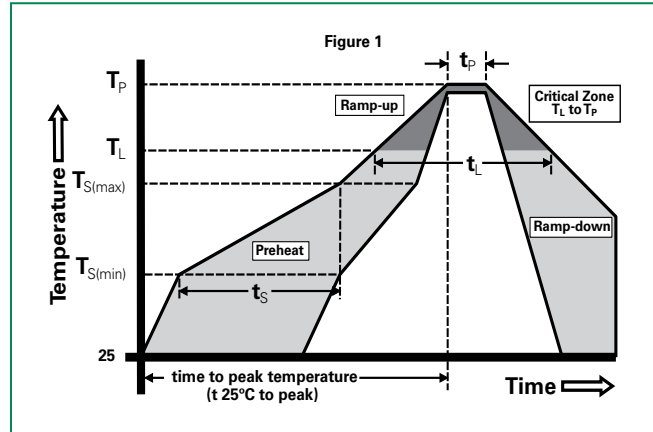

**Physical Specifications**

<b>Lead Material</b>	Copper Alloy
<b>Terminal Finish</b>	100% Matte-Tin Plated
<b>Body Material</b>	UL Recognized epoxy with a V-0 flammability rating per ANSI/UL 94

**Environmental Specifications**

<b>High Temp Voltage Blocking</b>	80% Rated $V_{DRM}$ ( $V_{AC}$ Peak) +125°C or +150°C, 504 or 1008 hrs. MIL-STD-750 (Method 1040) JEDEC, JESD22-A-101
<b>Temp Cycling</b>	-65°C to +150°C, 15 min. dwell, 10 up to 100 cycles. MIL-STD-750 (Method 1051) EIA/JEDEC, JESD22-A-104
<b>Biased Temp &amp; Humidity</b>	52 $V_{DC}$ (+85°C) 85%RH, 504 up to 1008 hrs. EIA/JEDEC, JESD22-A-101
<b>High Temp Storage</b>	+150°C 1008 hrs. MIL-STD-750 (Method 1031) JEDEC, JESD22-A-101
<b>Low Temp Storage</b>	-65°C, 1008 hrs.
<b>Thermal Shock</b>	0°C to +100°C, 5 min. dwell, 10 sec. transfer, 10 cycles. MIL-STD-750 (Method 1056) JEDEC, JESD22-A-106
<b>Autoclave (Pressure Cooker Test)</b>	+121°C, 100%RH, 2atm, 24 up to 168 hrs. EIA/JEDEC, JESD22-A-102
<b>Resistance to Solder Heat</b>	+260°C, 30 secs. MIL-STD-750 (Method 2031)
<b>Moisture Sensitivity Level</b>	85%RH, +85°C, 168 hrs., 3 reflow cycles (+260°C Peak). JEDEC-J-STD-020, Level 1

### Part Numbering

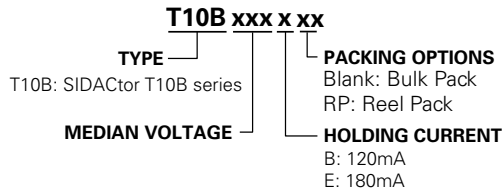

### Part Marking

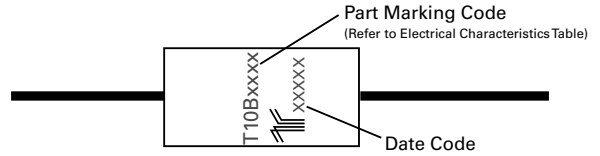

### Dimensions — DO-201AE

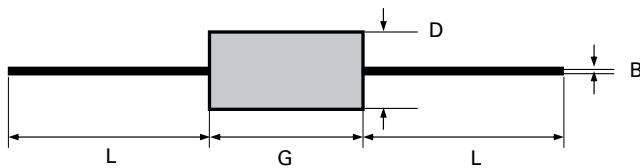

Dimension	Inches		Millimeters	
	MIN	MAX	MIN	MAX
<b>B</b>	0.037	0.042	0.94	1.067
<b>D</b>	0.190	0.205	4.826	5.207
<b>G</b>	0.360	0.375	9.146	9.527
<b>L</b>	1		25.4	

### Packing Options

Package Type	Description	Quantity	Added Suffix	Industry Standard
T10B	DO-201AE Tape and Reel Pack	1000	RP	EIA-RS-296-D
	DO-201AE Bulk Pack	500	N/A	N/A

### Tape and Reel Specification — DO-201AE

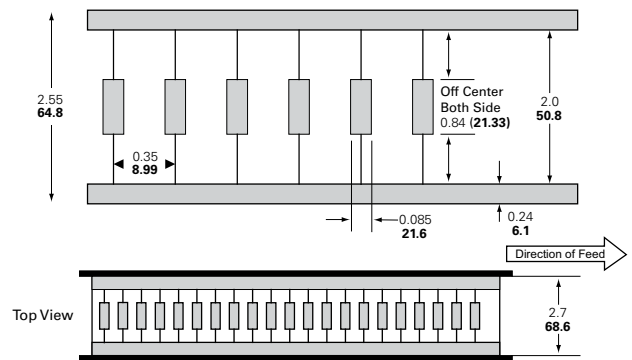

### Additional Information



Datasheet



Resources



Samples

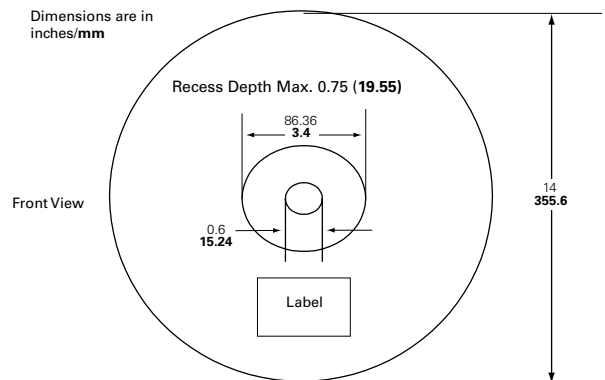

**Disclaimer Notice - Information furnished is believed to be accurate and reliable. However, users should independently evaluate the suitability of and test each product selected for their own applications. Littelfuse products are not designed for, and may not be used in, all applications. Read complete Disclaimer Notice at [www.littelfuse.com/disclaimer-electronics](http://www.littelfuse.com/disclaimer-electronics).**