



Shanghai Lunsure Electronic  
Technology Co.,Ltd  
Tel:0086-21-37185008  
Fax:0086-21-57152769

# MMBD4448

## Features

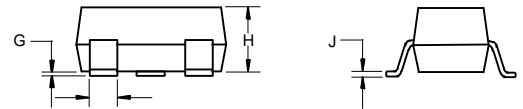
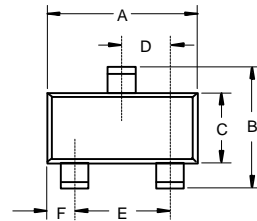
- Fast Switching Speed
- Surface Mount Package Ideally Suited for Automatic Insertion
- For General Purpose Switching Applications
- High Conductance

## Surface Mount Schottky Barrier Switching Diode 350mW

## Mechanical Data

- Case: SOT-23, Molded Plastic
- Terminals: Solderable per MIL-STD-202, Method 208
- Polarity: See Diagram
- Marking: KA3

### SOT-23



### Maximum Ratings @ 25°C Unless Otherwise Specified

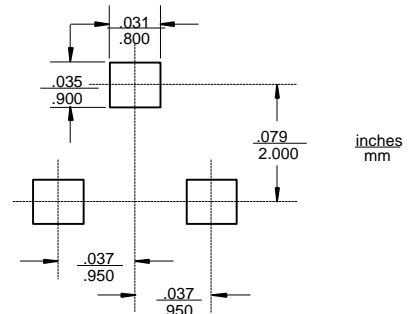
Characteristic	Symbol	Value	Unit
Non-Repetitive Peak Reverse Volt.	$V_{RM}$	100	V
Peak Repetitive Reverse Voltage	$V_{RRM}$	75	V
Working Peak Reverse Voltage	$V_{RWM}$		
DC Blocking Voltage	$V_R$		
RMS Reverse Voltage	$V_{R(RMS)}$	53	V
Forward Continuous Current(Note1)	$I_{FM}$	500	mA
Average Rectified Output Current	$I_o$	250	mA
Non-Repetitive Peak @ $t \leq 1.0s$	$I_{FSM}$	2	A
Forward Surge Current @ $t = 1.0us$		4	A
Power Dissipation(Note 1)	$P_d$	350	mW
Thermal Resistance(Note 1)	$R$	357	K/W
Operation/Storage Temp. Range	$T_j, T_{STG}$	-55 to +150	°C

DIM	DIMENSIONS				NOTE
	INCHES		MM		
A	.110	.120	2.80	3.04	
B	.083	.098	2.10	2.64	
C	.047	.055	1.20	1.40	
D	.035	.041	.89	1.03	
E	.070	.081	1.78	2.05	
F	.018	.024	.45	.60	
G	.0005	.0039	.013	.100	
H	.035	.044	.89	1.12	
J	.003	.007	.085	.180	
K	.015	.020	.37	.51	

### Electrical Characteristics @ 25°C Unless Otherwise Specified

Charateristic	Symbol	Min	Max	Unit	Test Cond.
Maximum Forward Voltage Drop	$V_{FM}$	0.62	0.72	V	$I_F = 5.0mA$
		-----	0.855		$I_F = 10mA$
			1		$I_F = 100mA$
			1.25		$I_F = 150mA$
Maximum Peak Reverse Current	$I_{RM}$	-----	2.5	uA	$V_R = 75V$
			50		$V_R = 75V T_j = 150^\circ C$
			30		$V_R = 25V T_j = 150^\circ C$
			25		$V_R = 20V$
Junction Capacitance	$C_j$	-----	4	pF	$V_R = 0V, f = 1.0MHz$
Reverse Recovery Time	$t_{rr}$	-----	4	ns	

### Suggested Solder Pad Layout

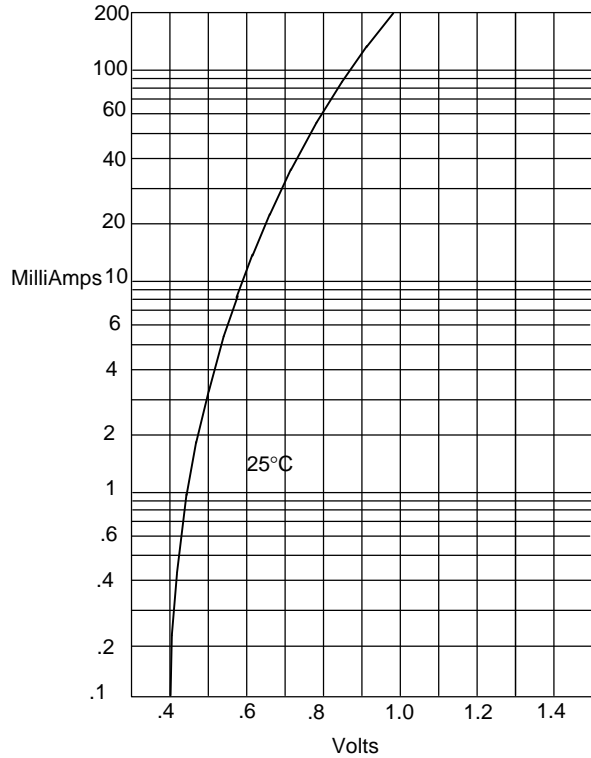


- Note: 1. Valid provided that terminals are kept at ambient temperature  
2.  $T_{rr}$  Test Condition:  $I_F = I_R = 10mA, I_{rr} = 0.1 * I_R, R = 100 OHM$

# MMBD4448

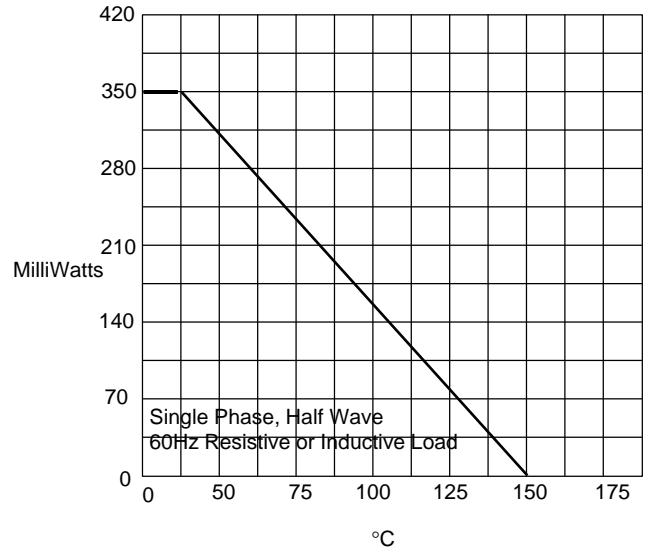


Figure 1  
Typical Forward Characteristics



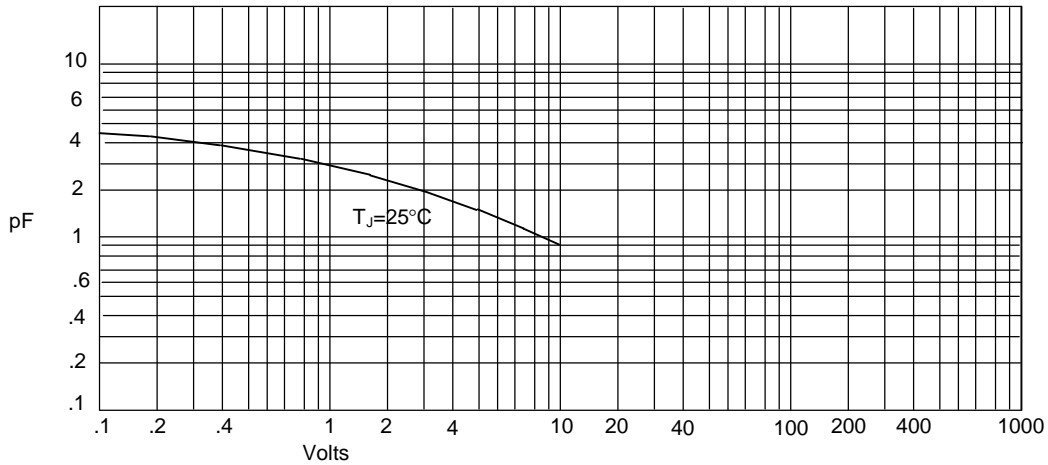
Instantaneous Forward Current - Amperes versus  
Instantaneous Forward Voltage - Volts

Figure 2  
Forward Derating Curve



Admissible Power Dissipation - MilliWatts versus  
Ambient Temperature - °C

Figure 3  
Junction Capacitance

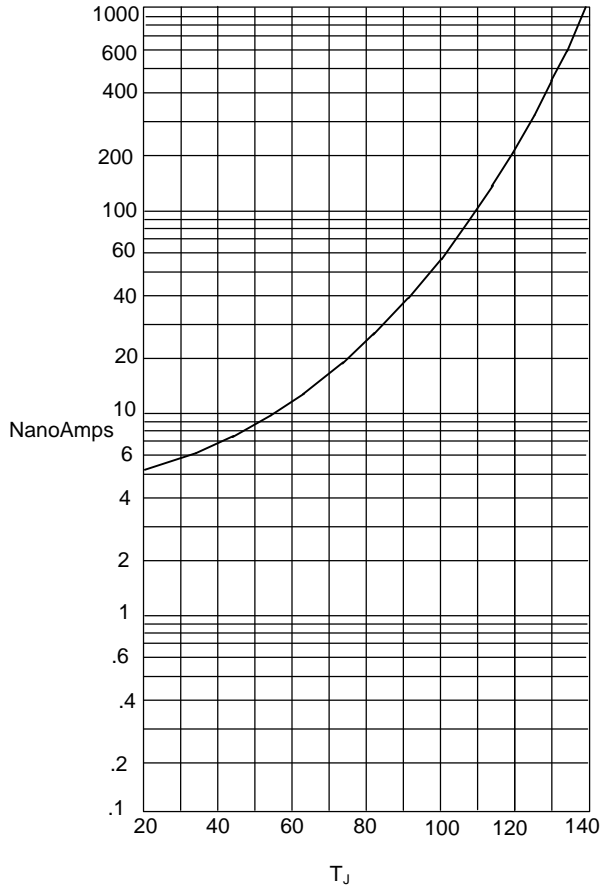


Junction Capacitance - pF versus  
Reverse Voltage - Volts

# MMBD4448



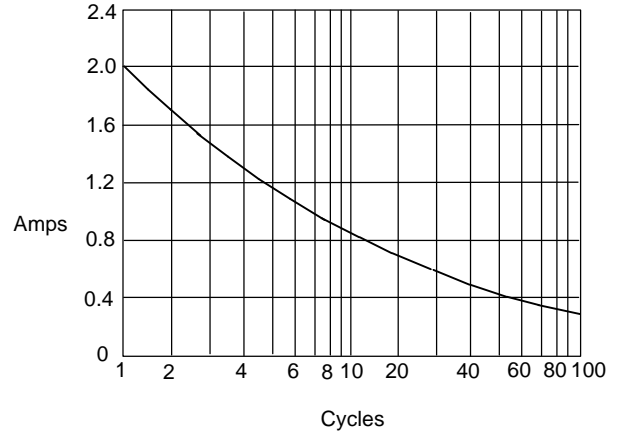
Figure 4  
Typical Reverse Characteristics



Instantaneous Reverse Leakage Current - NanoAmperes versus Junction Temperature - °C

T<sub>A</sub>=25°C  
T<sub>A</sub>=100°C

Figure 5  
Peak Forward Surge Current



Peak Forward Surge Current - Amperes versus Number Of Cycles At 60Hz - Cycles