

FS10ASH-06

HIGH-SPEED SWITCHING USE

FS10ASH-06



- 2.5V DRIVE
- V_{DSS} 60V
- $r_{DS(ON)}(MAX)$ $73m\Omega$
- I_D 10A
- Integrated Fast Recovery Diode (TYP.) 55ns

OUTLINE DRAWING Dimensions in mm

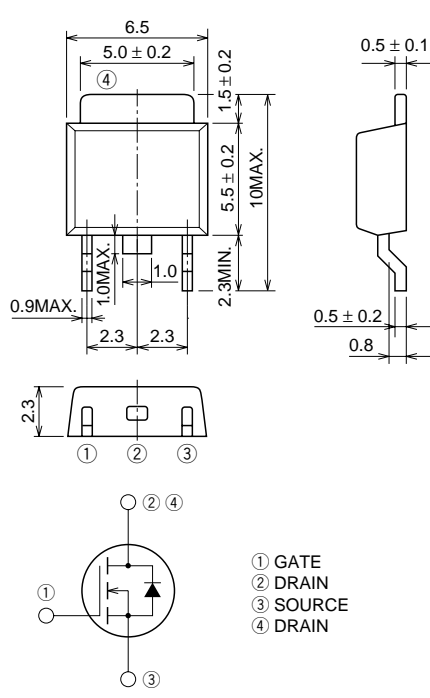

MP-3

APPLICATION

Motor control, Lamp control, Solenoid control
DC-DC converter, etc.

MAXIMUM RATINGS ($T_c = 25^\circ C$)

Symbol	Parameter	Conditions	Ratings	Unit
V_{DSS}	Drain-source voltage	$V_{GS} = 0V$	60	V
V_{GSS}	Gate-source voltage	$V_{DS} = 0V$	± 10	V
I_D	Drain current		10	A
I_{DM}	Drain current (Pulsed)		40	A
I_{DA}	Avalanche drain current (Pulsed)	$L = 100\mu H$	10	A
I_S	Source current		10	A
I_{SM}	Source current (Pulsed)		40	A
P_D	Maximum power dissipation		30	W
T_{ch}	Channel temperature		$-55 \sim +150$	$^\circ C$
T_{stg}	Storage temperature		$-55 \sim +150$	$^\circ C$
—	Weight	Typical value	0.26	g

ELECTRICAL CHARACTERISTICS (T_{ch} = 25°C)

Symbol	Parameter	Test conditions	Limits			Unit
			Min.	Typ.	Max.	
V (BR) DSS	Drain-source breakdown voltage	I _D = 1mA, V _{GS} = 0V	60	—	—	V
I _{GSS}	Gate-source leakage current	V _{GS} = ±10V, V _{DS} = 0V	—	—	±0.1	μA
I _{DSS}	Drain-source leakage current	V _{DS} = 60V, V _{GS} = 0V	—	—	0.1	mA
V _{GS} (th)	Gate-source threshold voltage	I _D = 1mA, V _{DS} = 10V	0.6	0.9	1.2	V
r _{DS} (ON)	Drain-source on-state resistance	I _D = 5A, V _{GS} = 4V	—	54	73	mΩ
r _{DS} (ON)	Drain-source on-state resistance	I _D = 5A, V _{GS} = 2.5V	—	64	95	mΩ
V _{DS} (ON)	Drain-source on-state voltage	I _D = 5A, V _{GS} = 4V	—	0.27	0.365	V
y _{fs}	Forward transfer admittance	I _D = 5A, V _{DS} = 5V	—	18	—	S
C _{iss}	Input capacitance	V _{DS} = 10V, V _{GS} = 0V, f = 1MHz	—	1150	—	pF
C _{oss}	Output capacitance		—	185	—	pF
C _{rss}	Reverse transfer capacitance		—	80	—	pF
t _d (on)	Turn-on delay time	V _{DD} = 30V, I _D = 5A, V _{GS} = 4V, R _{GEN} = R _{GS} = 50Ω	—	19	—	ns
t _r	Rise time		—	45	—	ns
t _d (off)	Turn-off delay time		—	90	—	ns
t _f	Fall time		—	65	—	ns
V _{SD}	Source-drain voltage	I _S = 5A, V _{GS} = 0V	—	1.0	1.5	V
R _{th} (ch-c)	Thermal resistance	Channel to case	—	—	4.17	°C/W
t _{rr}	Reverse recovery time	I _S = 10A, di _s /dt = -100A/μs	—	55	—	ns

PERFORMANCE CURVES

POWER DISSIPATION DERATING CURVE

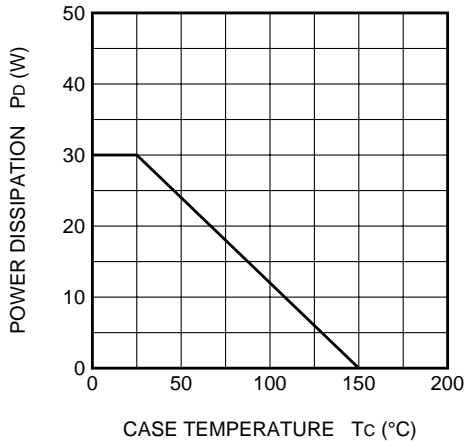

MAXIMUM SAFE OPERATING AREA

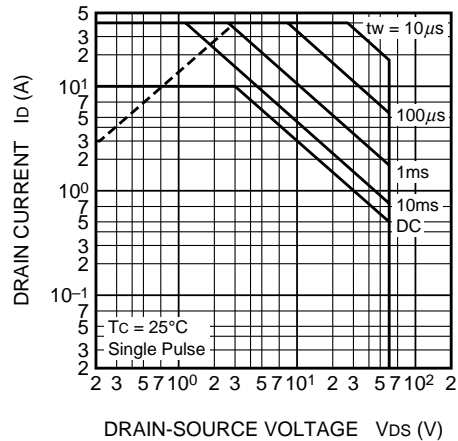

OUTPUT CHARACTERISTICS (TYPICAL)

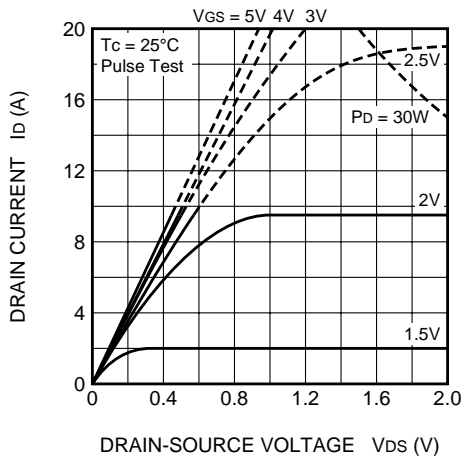

OUTPUT CHARACTERISTICS (TYPICAL)

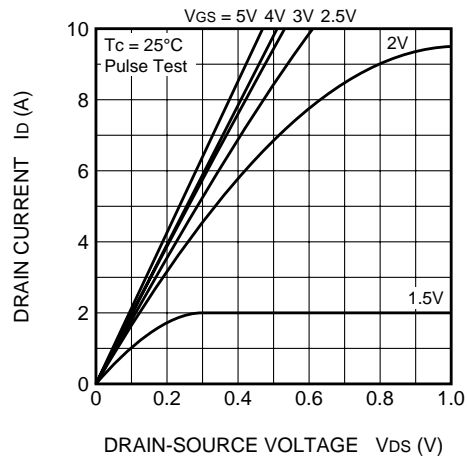

ON-STATE VOLTAGE VS. GATE-SOURCE VOLTAGE (TYPICAL)

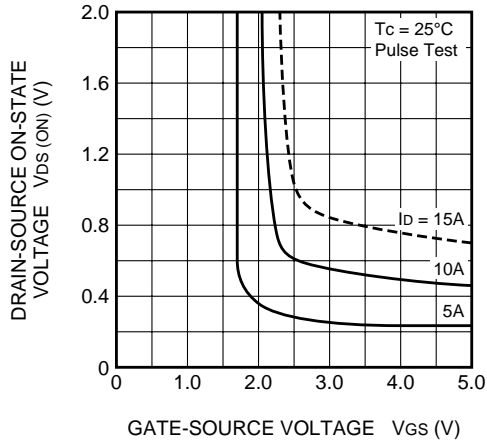

ON-STATE RESISTANCE VS. DRAIN CURRENT (TYPICAL)

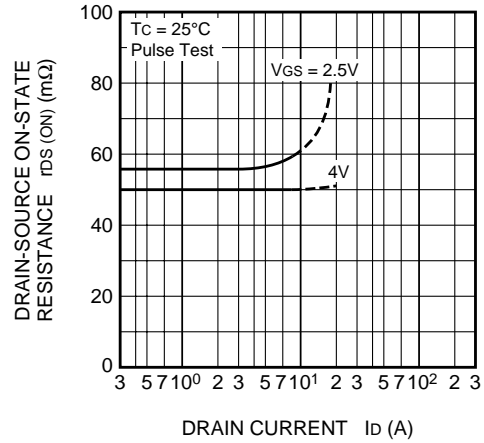

TRANSFER CHARACTERISTICS (TYPICAL)

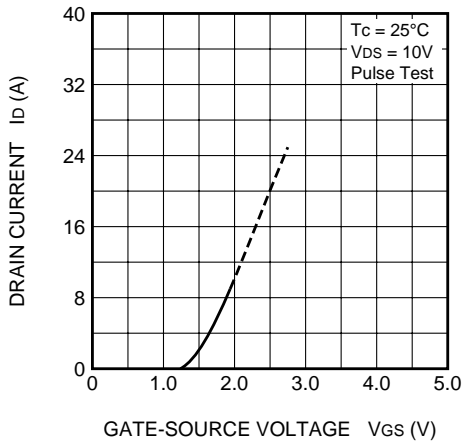

FORWARD TRANSFER ADMITTANCE VS. DRAIN CURRENT (TYPICAL)

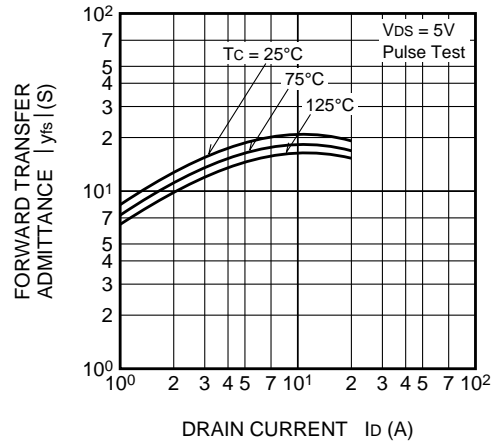

CAPACITANCE VS. DRAIN-SOURCE VOLTAGE (TYPICAL)

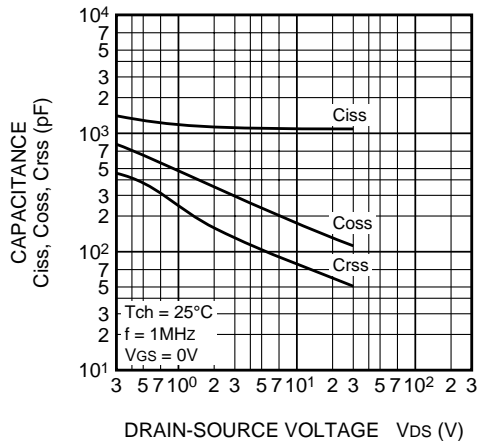

SWITCHING CHARACTERISTICS (TYPICAL)

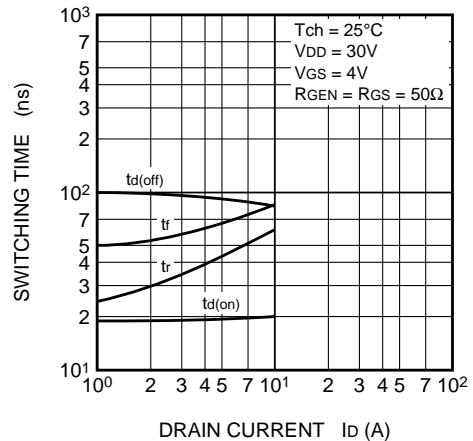

GATE-SOURCE VOLTAGE VS. GATE CHARGE (TYPICAL)

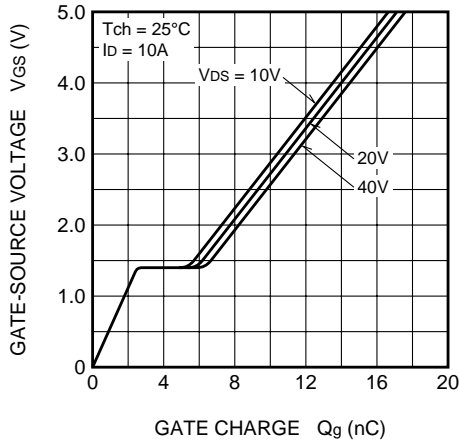

SOURCE-DRAIN DIODE FORWARD CHARACTERISTICS (TYPICAL)

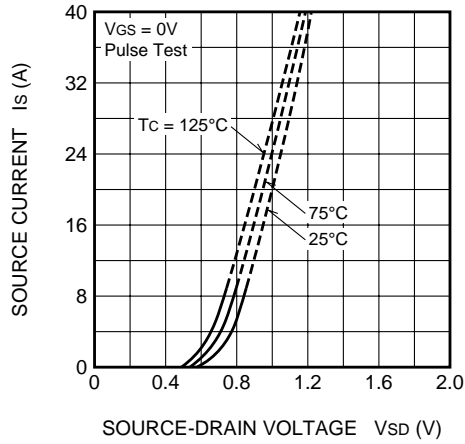

ON-STATE RESISTANCE VS. CHANNEL TEMPERATURE (TYPICAL)

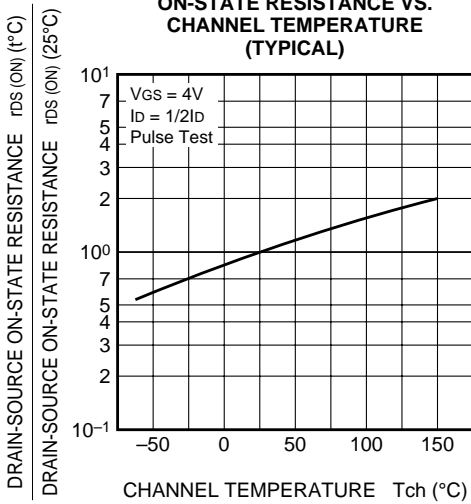

THRESHOLD VOLTAGE VS. CHANNEL TEMPERATURE (TYPICAL)

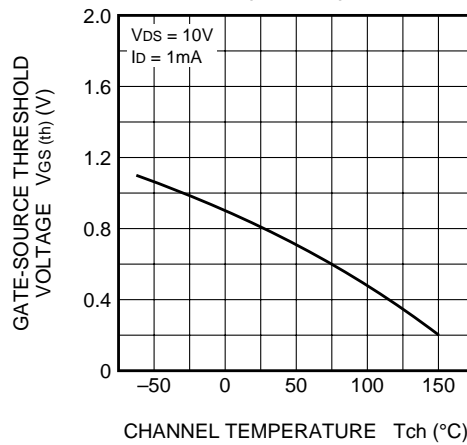

BREAKDOWN VOLTAGE VS. CHANNEL TEMPERATURE (TYPICAL)

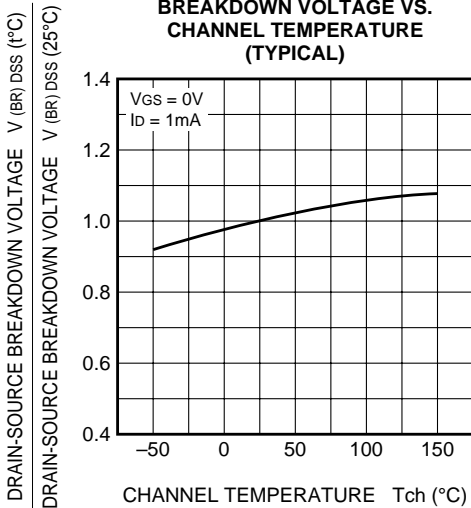

TRANSIENT THERMAL IMPEDANCE CHARACTERISTICS

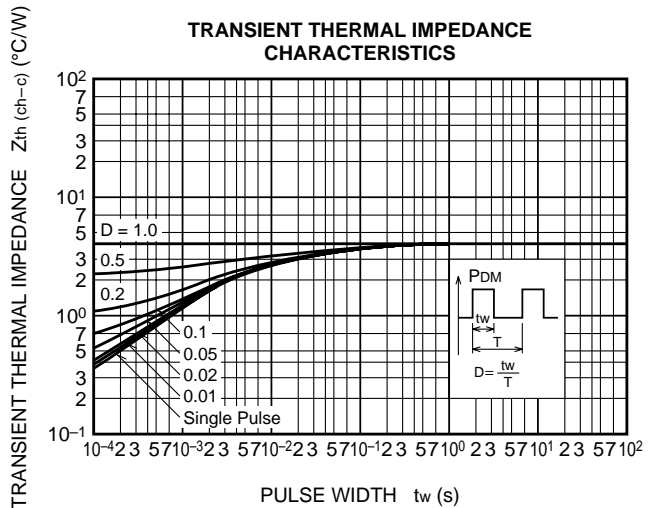

This datasheet has been download from:

www.datasheetcatalog.com

Datasheets for electronics components.