



ON Semiconductor®

August 2017

# ISL9K460P3 8 A, 600 V, STEALTH™ II Diode

## Features

- Stealth Recovery  $t_{rr} = 17$  ns (@  $I_F = 4$  A)
- Max Forward Voltage,  $V_F = 2.4$  V (@  $T_C = 25^\circ\text{C}$ )
- 600 V Reverse Voltage and High Reliability
- Avalanche Energy Rated
- RoHS Compliant

## Applications

- SMPS FWD
- Hard Switched PFC Boost Diode
- UPS Free Wheeling Diode
- Motor Drive FWD
- Snubber Diode

## Description

The ISL9K460P3 is a STEALTH™ dual diode optimized for low loss performance in high frequency hard switched applications. The STEALTH™ family exhibits low reverse recovery current ( $I_{rr}$ ) and exceptionally soft recovery under typical operating conditions. This device is intended for use as a free wheeling or boost diode in power supplies and other power switching applications. The low  $I_{rr}$  and short  $t_a$  phase reduce loss in switching transistors. The soft recovery minimizes ringing, expanding the range of conditions under which the diode may be operated without the use of additional snubber circuitry. Consider using the STEALTH™ diode with an SMPS IGBT to provide the most efficient and highest power density design at lower cost.

## Package

JEDEC TO-220AB

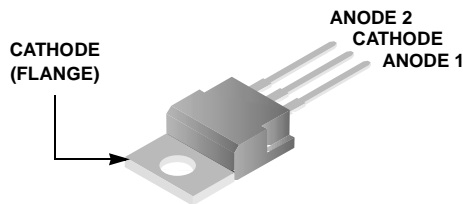

## Symbol

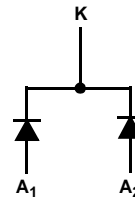

## Device Maximum Ratings (per leg) $T_C = 25^\circ\text{C}$ unless otherwise noted

Symbol	Parameter	Rating	Unit
$V_{RRM}$	Peak Repetitive Reverse Voltage	600	V
$V_{RWM}$	Working Peak Reverse Voltage	600	V
$V_R$	DC Blocking Voltage	600	V
$I_{F(AV)}$	Average Rectified Forward Current ( $T_C = 155^\circ\text{C}$ )	4	A
	Total Device Current (Both Legs)	8	A
$I_{FRM}$	Repetitive Peak Surge Current (20kHz Square Wave)	8	A
$I_{FSM}$	Nonrepetitive Peak Surge Current (Halfwave 1 Phase 60Hz)	50	A
$P_D$	Power Dissipation	58	W
$E_{AVL}$	Avalanche Energy (0.5A, 80mH)	10	mJ
$T_J, T_{STG}$	Operating and Storage Temperature Range	-55 to 175	$^\circ\text{C}$
$T_L$ $T_{PKG}$	Maximum Temperature for Soldering	300	$^\circ\text{C}$
	Leads at 0.063in (1.6mm) from Case for 10s Package Body for 10s, See Techbrief TB334	260	$^\circ\text{C}$

CAUTION: Stresses above those listed in "Device Maximum Ratings" may cause permanent damage to the device. This is a stress only rating and operation of the device at these or any other conditions above those indicated in the operational sections of this specification is not implied.

ISL9K460P3 — STEALTH™ Dual Diode

**Package Marking and Ordering Information**

Part Number	Top Mark	Package	Packing Method	Reel Size	Tape Width	Quantity
ISL9K460P3	K460P3	TO-220	Tube	N/A	N/A	50

**Electrical Characteristics (per leg)**  $T_C = 25^\circ\text{C}$  unless otherwise noted

Symbol	Parameter	Test Conditions	Min	Typ	Max	Unit
--------	-----------	-----------------	-----	-----	-----	------

**Off State Characteristics**

$I_R$	Instantaneous Reverse Current	$V_R = 600\text{ V}$	$T_C = 25^\circ\text{C}$	-	-	100	$\mu\text{A}$
			$T_C = 125^\circ\text{C}$	-	-	1.0	$\text{mA}$

**On State Characteristics**

$V_F$	Instantaneous Forward Voltage	$I_F = 4\text{ A}$	$T_C = 25^\circ\text{C}$	-	2.0	2.4	$\text{V}$
			$T_C = 125^\circ\text{C}$	-	1.6	2.0	$\text{V}$

**Dynamic Characteristics**

$C_J$	Junction Capacitance	$V_R = 10\text{ V}, I_F = 0\text{ A}$	-	19	-	$\text{pF}$
-------	----------------------	---------------------------------------	---	----	---	-------------

**Switching Characteristics**

$t_{rr}$	Reverse Recovery Time	$I_F = 1\text{ A}, di_F/dt = 100\text{ A}/\mu\text{s}, V_R = 30\text{ V}$	-	17	20	$\text{ns}$
		$I_F = 4\text{ A}, di_F/dt = 100\text{ A}/\mu\text{s}, V_R = 30\text{ V}$	-	19	22	$\text{ns}$
$t_{rr}$	Reverse Recovery Time	$I_F = 4\text{ A},$ $di_F/dt = 200\text{ A}/\mu\text{s}, V_R = 390\text{ V},$ $T_C = 25^\circ\text{C}$	-	17	-	$\text{ns}$
$I_{rr}$	Reverse Recovery Current		-	2.6	-	$\text{A}$
$Q_{rr}$	Reverse Recovery Charge		-	22	-	$\text{nC}$
$t_{rr}$	Reverse Recovery Time		-	77	-	$\text{ns}$
S	Softness Factor ( $t_b/t_a$ )	$I_F = 4\text{ A},$ $di_F/dt = 200\text{ A}/\mu\text{s},$ $V_R = 390\text{ V},$ $T_C = 125^\circ\text{C}$	-	4.2	-	
$I_{rr}$	Reverse Recovery Current		-	2.8	-	$\text{A}$
$Q_{rr}$	Reverse Recovery Charge		-	100	-	$\text{nC}$
$t_{rr}$	Reverse Recovery Time		-	54	-	$\text{ns}$
S	Softness Factor ( $t_b/t_a$ )	$I_F = 4\text{ A},$ $di_F/dt = 400\text{ A}/\mu\text{s},$ $V_R = 390\text{ V},$ $T_C = 125^\circ\text{C}$	-	3.5	-	
$I_{rr}$	Reverse Recovery Current		-	4.3	-	$\text{A}$
$Q_{rr}$	Reverse Recovery Charge		-	110	-	$\text{nC}$
$di_M/dt$	Maximum $di/dt$ during $t_b$		-	500	-	$\text{A}/\mu\text{s}$

**Thermal Characteristics**

$R_{\theta JC}$	Thermal Resistance Junction to Case		-	-	2.6	$^\circ\text{C}/\text{W}$
$R_{\theta JA}$	Thermal Resistance Junction to Ambient	TO-220	-	-	62	$^\circ\text{C}/\text{W}$

Typical Performance Curves

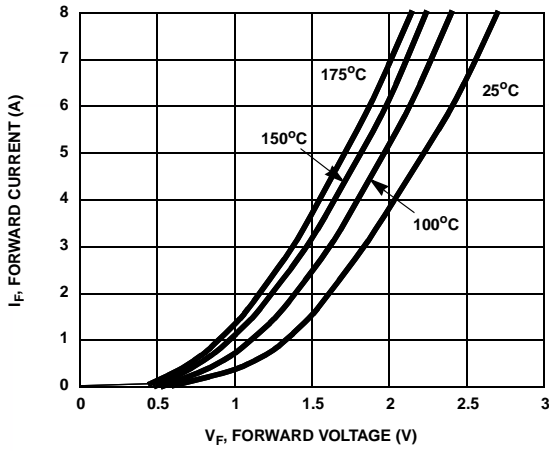

Figure 1. Forward Current vs Forward Voltage

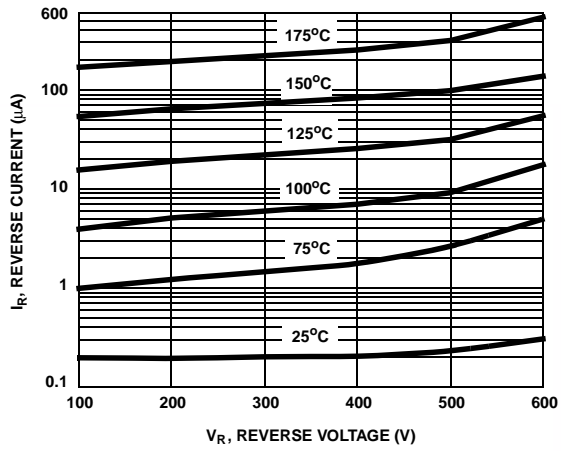

Figure 2. Reverse Current vs Reverse Voltage

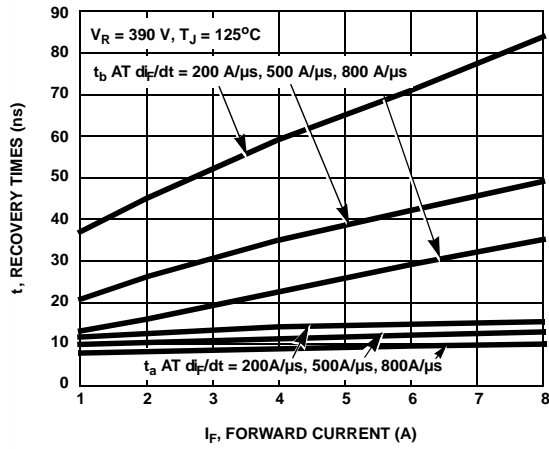

Figure 3.  $t_a$  and  $t_b$  Curves vs Forward Current

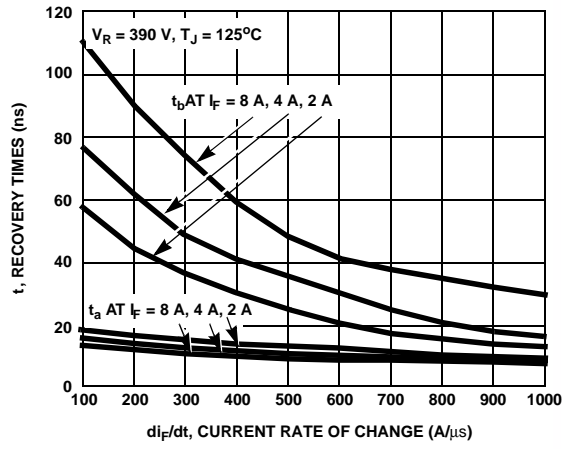

Figure 4.  $t_a$  and  $t_b$  Curves vs  $di_F/dt$

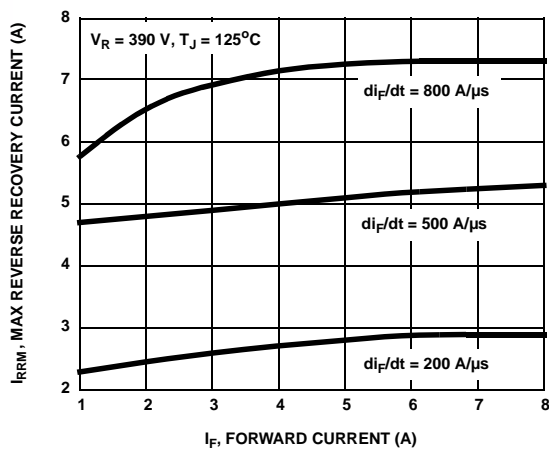

Figure 5. Maximum Reverse Recovery Current vs Forward Current

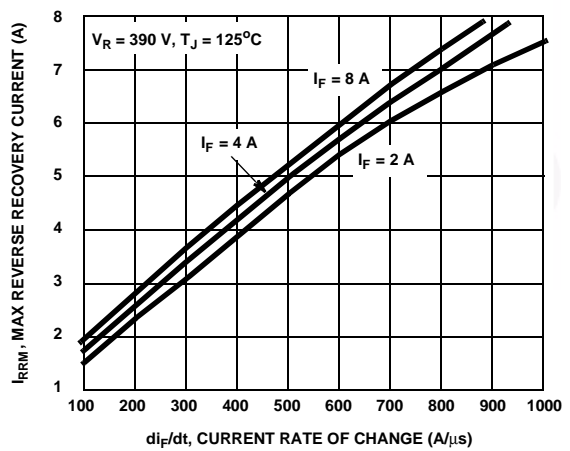

Figure 6. Maximum Reverse Recovery Current vs  $di_F/dt$

Typical Performance Curves (Continued)

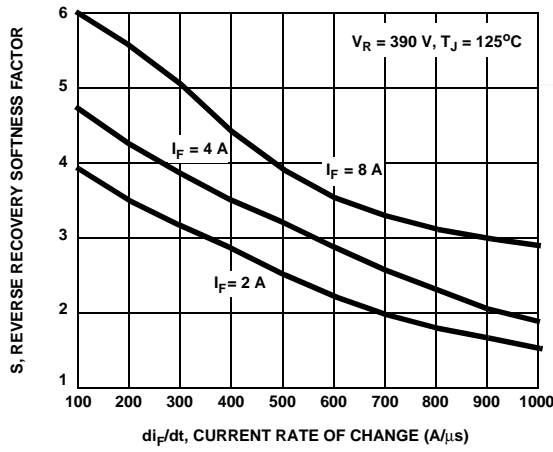

Figure 7. Reverse Recovery Softness Factor vs  $di_F/dt$

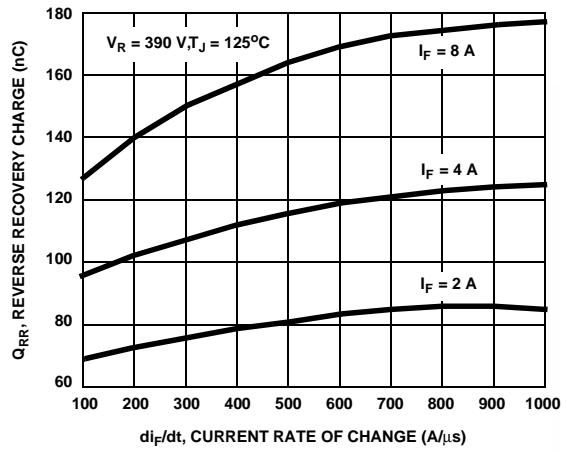

Figure 8. Reverse Recovery Charge vs  $di_F/dt$

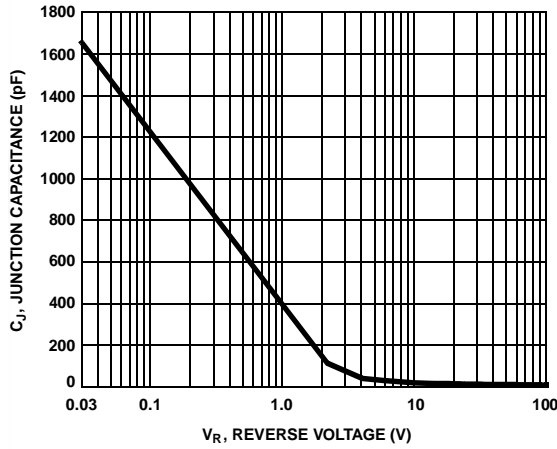

Figure 9. Junction Capacitance vs Reverse Voltage

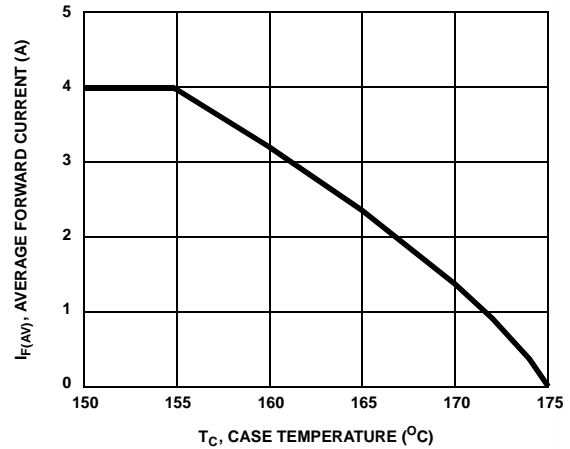

Figure 10. DC Current Derating Curve

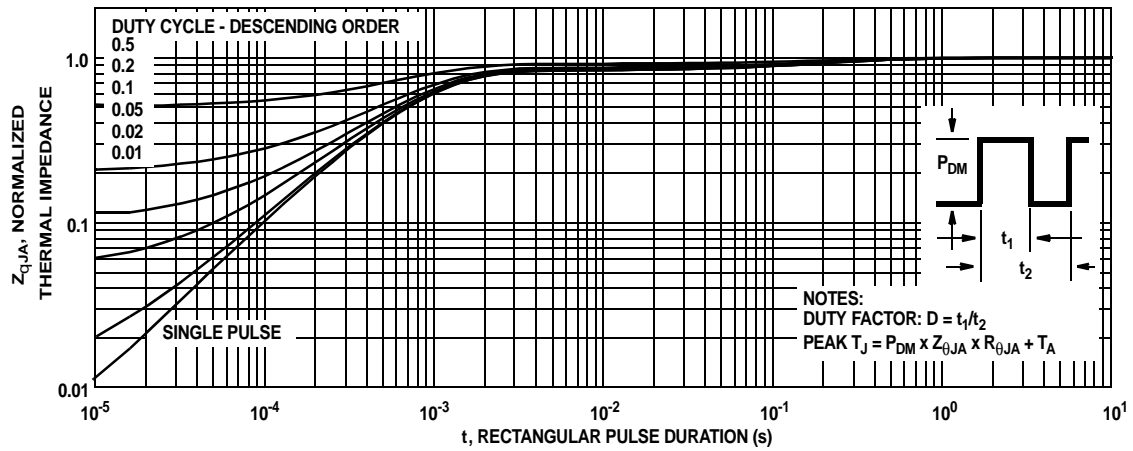

Figure 11. Normalized Maximum Transient Thermal Impedance

**Test Circuit and Waveforms**

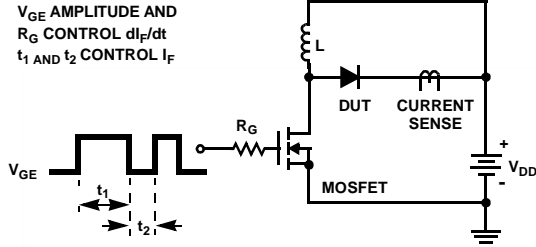

Figure 12.  $t_{rr}$  Test Circuit

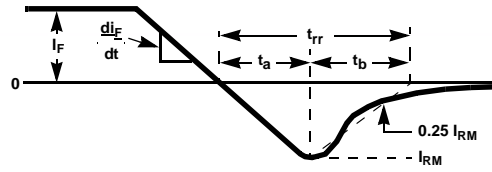

Figure 13.  $t_{rr}$  Waveforms and Definitions

$I = 0.5A$   
 $L = 80mH$   
 $R < 0.1\Omega$   
 $V_{DD} = 200V$   
 $E_{AVL} = 1/2LI^2 [V_{R(AVL)}/(V_{R(AVL)} - V_{DD})]$   
 $Q_1 = IGBT (BV_{CES} > DUT V_{R(AVL)})$

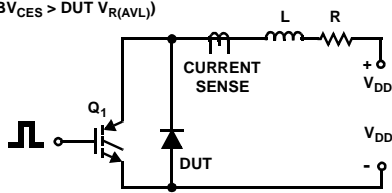

Figure 14. Avalanche Energy Test Circuit

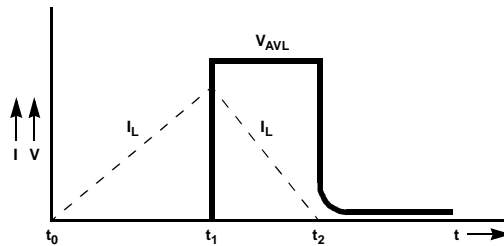
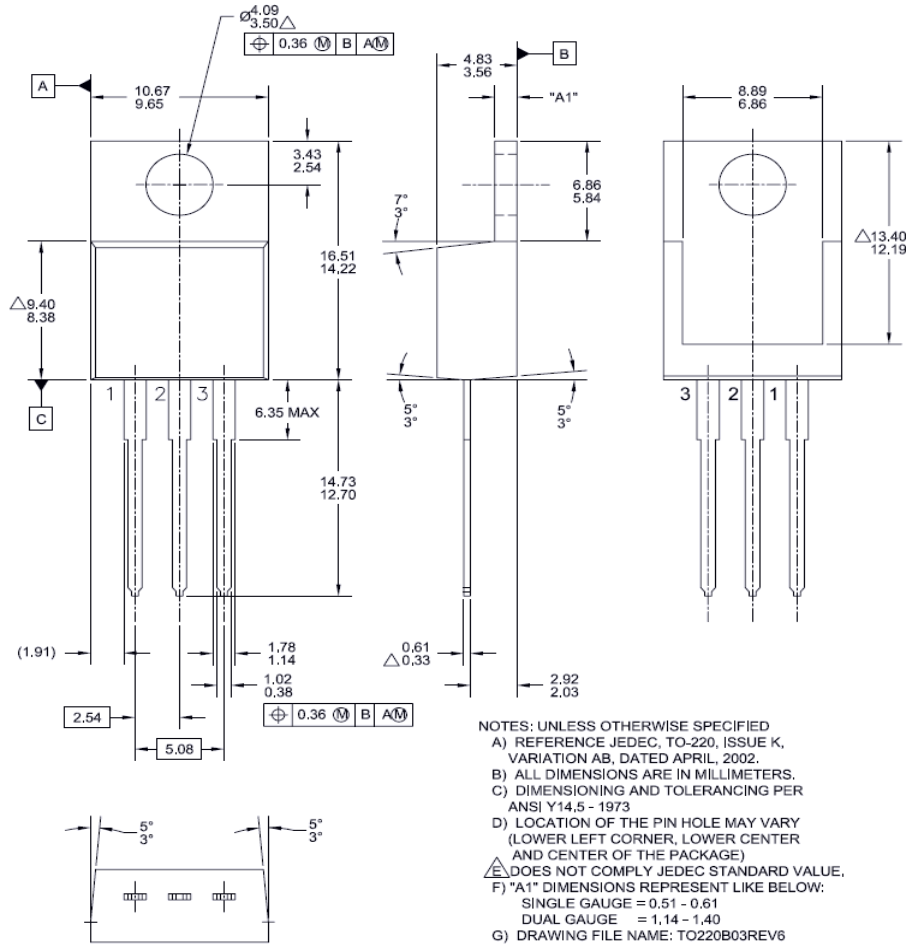

Figure 15. Avalanche Current and Voltage Waveforms

**Mechanical Dimensions**



**Figure 16. TO-220 3L - TO-220, MOLDED, 3LEAD, JEDEC VARIATION AB**

ON Semiconductor and are trademarks of Semiconductor Components Industries, LLC dba ON Semiconductor or its subsidiaries in the United States and/or other countries. ON Semiconductor owns the rights to a number of patents, trademarks, copyrights, trade secrets, and other intellectual property. A listing of ON Semiconductor's product/patent coverage may be accessed at [www.onsemi.com/site/pdf/Patent-Marking.pdf](http://www.onsemi.com/site/pdf/Patent-Marking.pdf). ON Semiconductor reserves the right to make changes without further notice to any products herein. ON Semiconductor makes no warranty, representation or guarantee regarding the suitability of its products for any particular purpose, nor does ON Semiconductor assume any liability arising out of the application or use of any product or circuit, and specifically disclaims any and all liability, including without limitation special, consequential or incidental damages. Buyer is responsible for its products and applications using ON Semiconductor products, including compliance with all laws, regulations and safety requirements or standards, regardless of any support or applications information provided by ON Semiconductor. "Typical" parameters which may be provided in ON Semiconductor data sheets and/or specifications can and do vary in different applications and actual performance may vary over time. All operating parameters, including "Typicals" must be validated for each customer application by customer's technical experts. ON Semiconductor does not convey any license under its patent rights nor the rights of others. ON Semiconductor products are not designed, intended, or authorized for use as a critical component in life support systems or any FDA Class 3 medical devices or medical devices with a same or similar classification in a foreign jurisdiction or any devices intended for implantation in the human body. Should Buyer purchase or use ON Semiconductor products for any such unintended or unauthorized application, Buyer shall indemnify and hold ON Semiconductor and its officers, employees, subsidiaries, affiliates, and distributors harmless against all claims, costs, damages, and expenses, and reasonable attorney fees arising out of, directly or indirectly, any claim of personal injury or death associated with such unintended or unauthorized use, even if such claim alleges that ON Semiconductor was negligent regarding the design or manufacture of the part. ON Semiconductor is an Equal Opportunity/Affirmative Action Employer. This literature is subject to all applicable copyright laws and is not for resale in any manner.

**PUBLICATION ORDERING INFORMATION**

**LITERATURE FULFILLMENT:**  
 Literature Distribution Center for ON Semiconductor  
 19521 E. 32nd Pkwy, Aurora, Colorado 80011 USA  
**Phone:** 303-675-2175 or 800-344-3860 Toll Free USA/Canada  
**Fax:** 303-675-2176 or 800-344-3867 Toll Free USA/Canada  
**Email:** [orderlit@onsemi.com](mailto:orderlit@onsemi.com)

**N. American Technical Support:** 800-282-9855 Toll Free  
 USA/Canada  
**Europe, Middle East and Africa Technical Support:**  
 Phone: 421 33 790 2910  
**Japan Customer Focus Center**  
 Phone: 81-3-5817-1050

**ON Semiconductor Website:** [www.onsemi.com](http://www.onsemi.com)  
**Order Literature:** <http://www.onsemi.com/orderlit>  
 For additional information, please contact your local Sales Representative