

# DATA SHEET

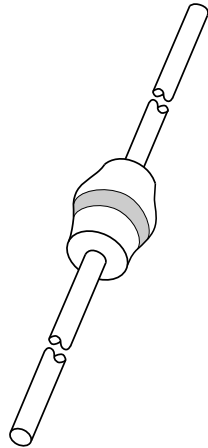

## **BYM63** Ripple blocking diode

Product specification  
Supersedes data of December 1995  
File under Discrete Semiconductors, SC01

1996 Jun 10

# Ripple blocking diode

# BYM63

## FEATURES

- Glass passivated
- High maximum operating temperature
- Low leakage current
- Excellent stability
- Guaranteed minimum turn-on time for absorbing forward current transients and oscillations
- Specially designed as rectifier in the auxiliary power supply in e.g. switched mode power supplies
- Available in ammo-pack.
- Also available with preformed leads for easy insertion.

## DESCRIPTION

Rugged glass SOD64 package, using a high temperature alloyed construction.

This package is hermetically sealed and fatigue free as coefficients of expansion of all used parts are matched.

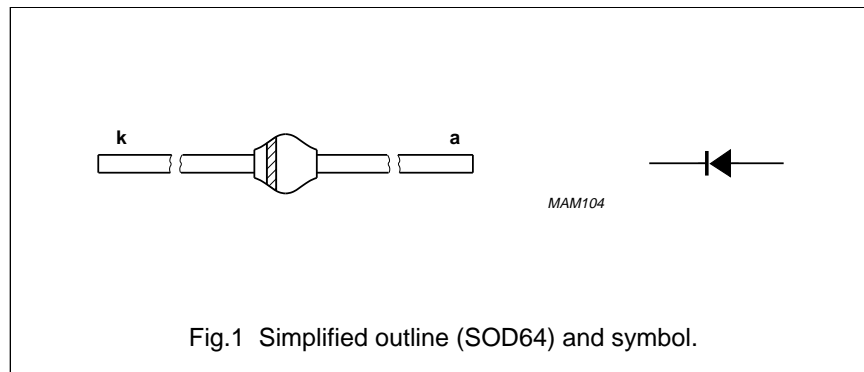

## LIMITING VALUES

In accordance with the Absolute Maximum Rating System (IEC 134).

SYMBOL	PARAMETER	CONDITIONS	MIN.	MAX.	UNIT
$V_{RRM}$	repetitive peak reverse voltage		–	300	V
$V_R$	continuous reverse voltage		–	300	V
$I_{F(AV)}$	average forward current	averaged over any 20 ms period; $T_{tp} = 55\text{ °C}$ ; lead length = 10 mm; see Fig.2; see also Fig.4	–	2.4	A
		averaged over any 20 ms period; $T_{amb} = 65\text{ °C}$ ; PCB mounting (Fig.8); see Fig.3; see also Fig.4	–	1.0	A
$I_{FRM}$	repetitive peak forward current	$T_{tp} = 55\text{ °C}$	–	21	A
		$T_{amb} = 65\text{ °C}$	–	8.5	A
$I_{FSM}$	non-repetitive peak forward current	$t = 10\text{ ms}$ half sine wave; $T_j = T_{jmax}$ prior to surge; $V_R = V_{RRMmax}$	–	45	A
$T_{stg}$	storage temperature		–65	+175	°C
$T_j$	junction temperature		–65	+175	°C

## Ripple blocking diode

## BYM63

**ELECTRICAL CHARACTERISTICS**

$T_j = 25\text{ °C}$  unless otherwise specified.

SYMBOL	PARAMETER	CONDITIONS	MIN.	TYP.	MAX.	UNIT
$V_F$	forward voltage	$I_F = 2\text{ A}$ ; $T_j = T_{j\text{ max}}$ ; see Fig.5	–	–	1.34	V
		$I_F = 2\text{ A}$ ; see Fig.5	–	–	2.30	V
$I_R$	reverse current	$V_R = V_{RRM\text{ max}}$ ; see Fig.6	–	–	10	$\mu\text{A}$
		$V_R = V_{RRM\text{ max}}$ ; $T_j = 165\text{ °C}$ ; see Fig.6	–	–	150	$\mu\text{A}$
$t_{fr}$	forward recovery time	when switched to $I_F = 5\text{ A}$ in 50 ns; see Fig.9	–	–	1.5	$\mu\text{s}$
$t_{on}$	turn-on time	when switched from $V_F = 0\text{ V}$ to $V_F = 3\text{ V}$ ; measured between 10% and 90% of $I_{F\text{ max}}$ ; see Fig.11	400	–	–	ns
$t_{rr}$	reverse recovery time	when switched from $I_F = 0.5\text{ A}$ to $I_R = 1\text{ A}$ ; measured at $I_R = 0.25\text{ A}$ ; see Fig.11	–	–	150	ns
$C_d$	diode capacitance	$f = 1\text{ MHz}$ ; $V_R = 0\text{ V}$ ; see Fig.7	–	65	–	pF

**THERMAL CHARACTERISTICS**

SYMBOL	PARAMETER	CONDITIONS	VALUE	UNIT
$R_{th\ j\text{-tp}}$	thermal resistance from junction to tie-point	lead length = 10 mm	25	K/W
$R_{th\ j\text{-a}}$	thermal resistance from junction to ambient	note 1	75	K/W

**Note**

1. Device mounted on an epoxy-glass printed-circuit board, 1.5 mm thick; thickness of Cu-layer  $\geq 40\text{ }\mu\text{m}$ , see Fig.8. For more information please refer to the 'General Part of Handbook SC01.'

Ripple blocking diode

BYM63

GRAPHICAL DATA

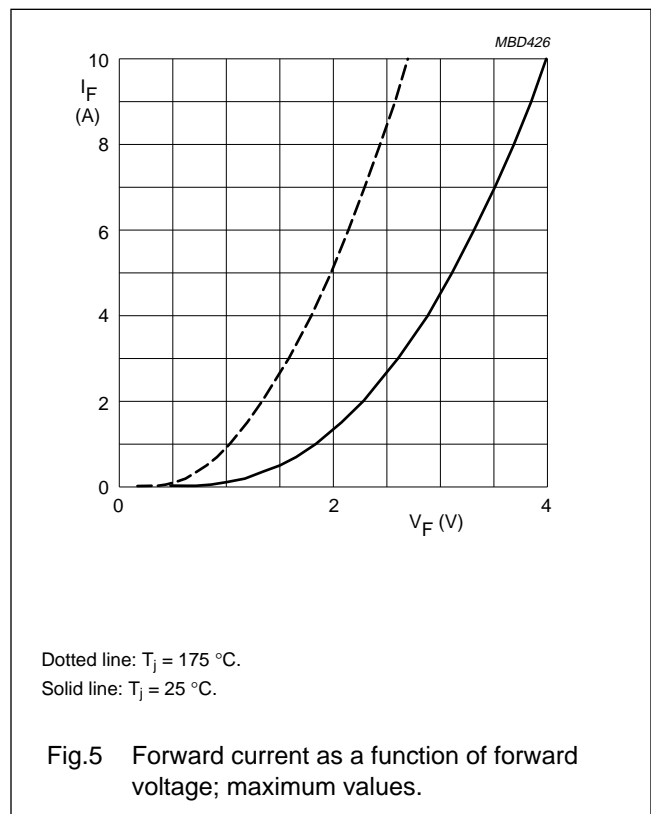
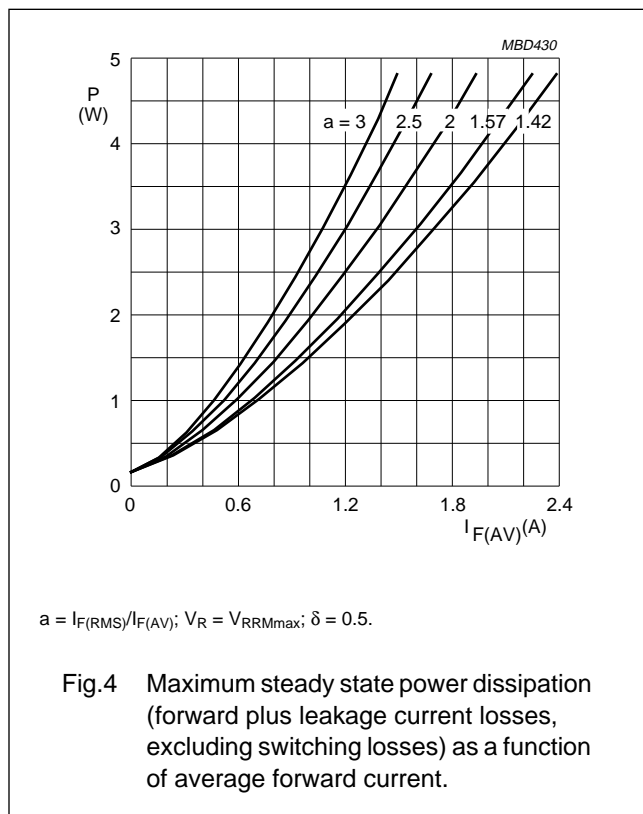
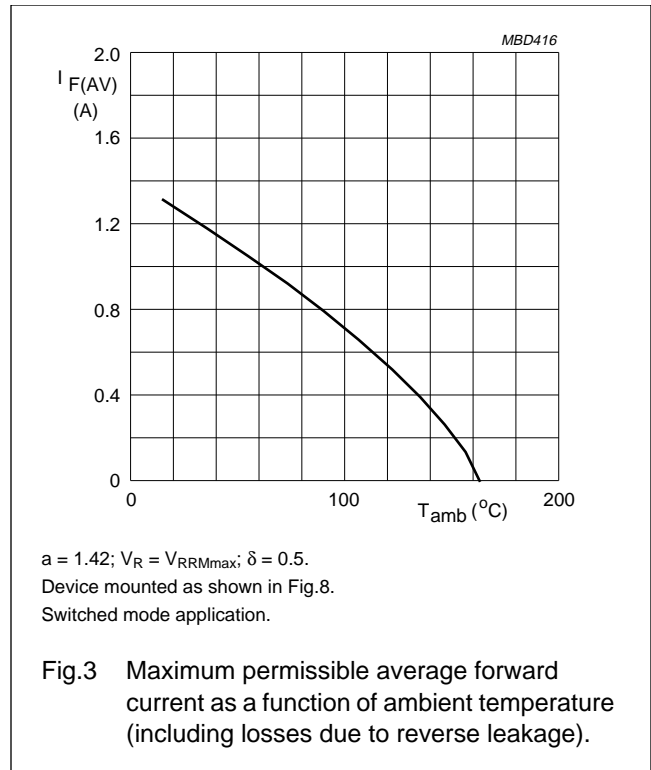
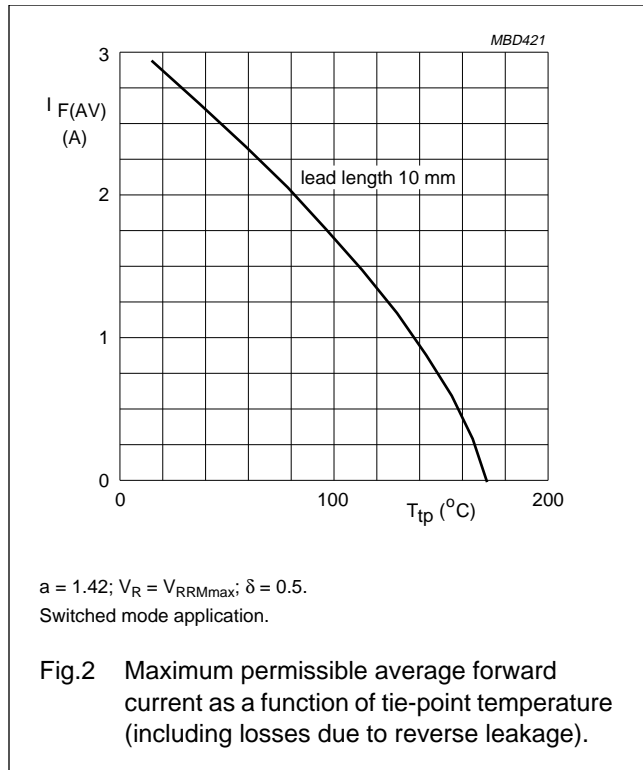

Ripple blocking diode

BYM63

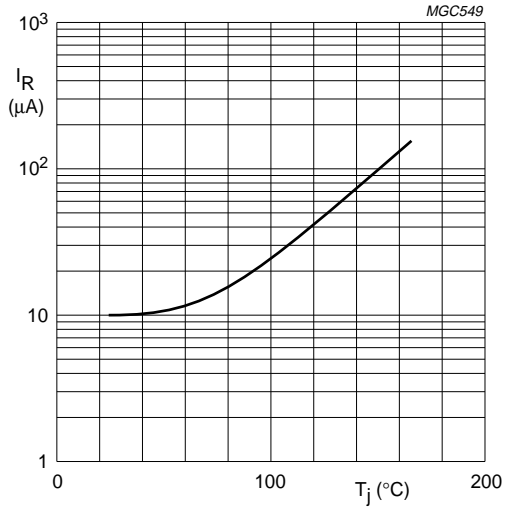

$V_R = V_{RRMmax}$ .

Fig.6 Reverse current as a function of junction temperature; maximum values.

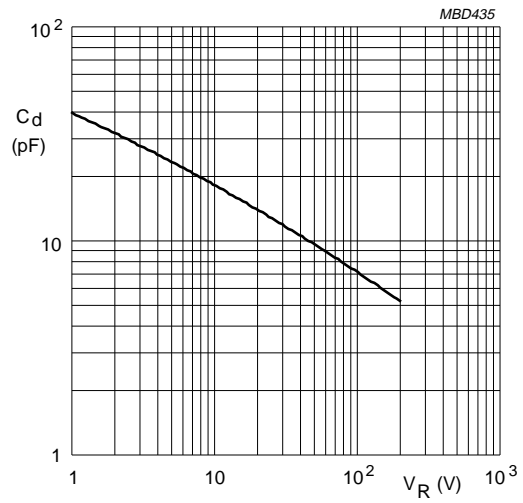

$f = 1 \text{ MHz}; T_j = 25 \text{ }^\circ\text{C}$ .

Fig.7 Diode capacitance as a function of reverse voltage; typical values.

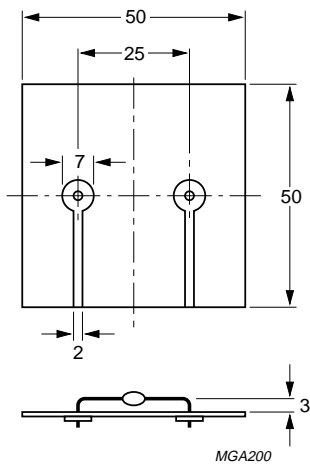

Dimensions in mm.

Fig.8 Device mounted on a printed-circuit board.

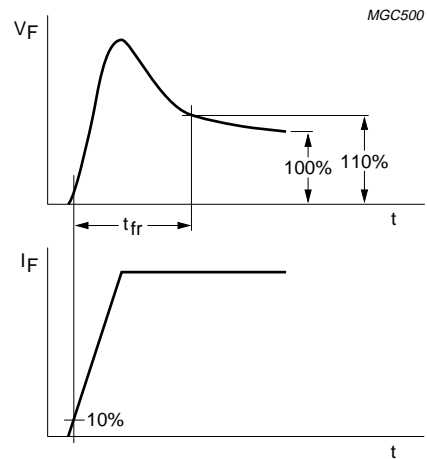
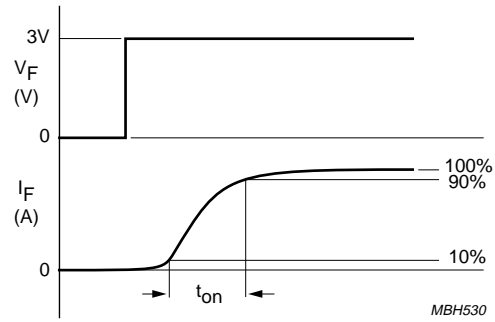
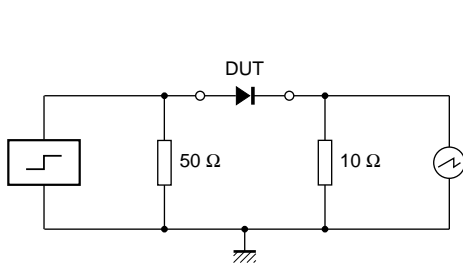

Fig.9 Forward recovery time definition.

Ripple blocking diode

BYM63



Input impedance oscilloscope: 1 MΩ, 22 pF;  $t_r \leq 7$  ns.  
 Source impedance: 50 Ω;  $t_r \leq 10$  ns.

Fig.10 Test circuit and turn-on time waveform and definition.

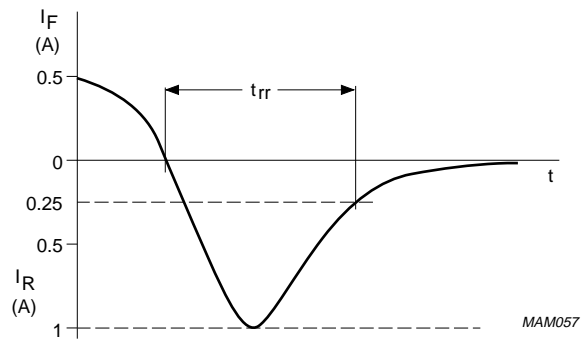
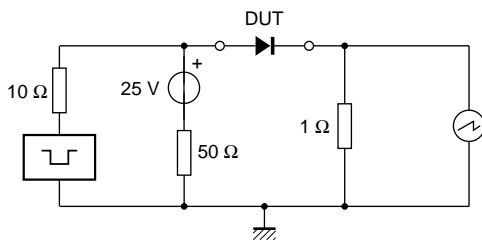

Input impedance oscilloscope: 1 MΩ, 22 pF;  $t_r \leq 7$  ns.  
 Source impedance: 50 Ω;  $t_r \leq 15$  ns.

Fig.11 Test circuit and reverse recovery time waveform and definition.

Ripple blocking diode

BYM63

PACKAGE OUTLINE

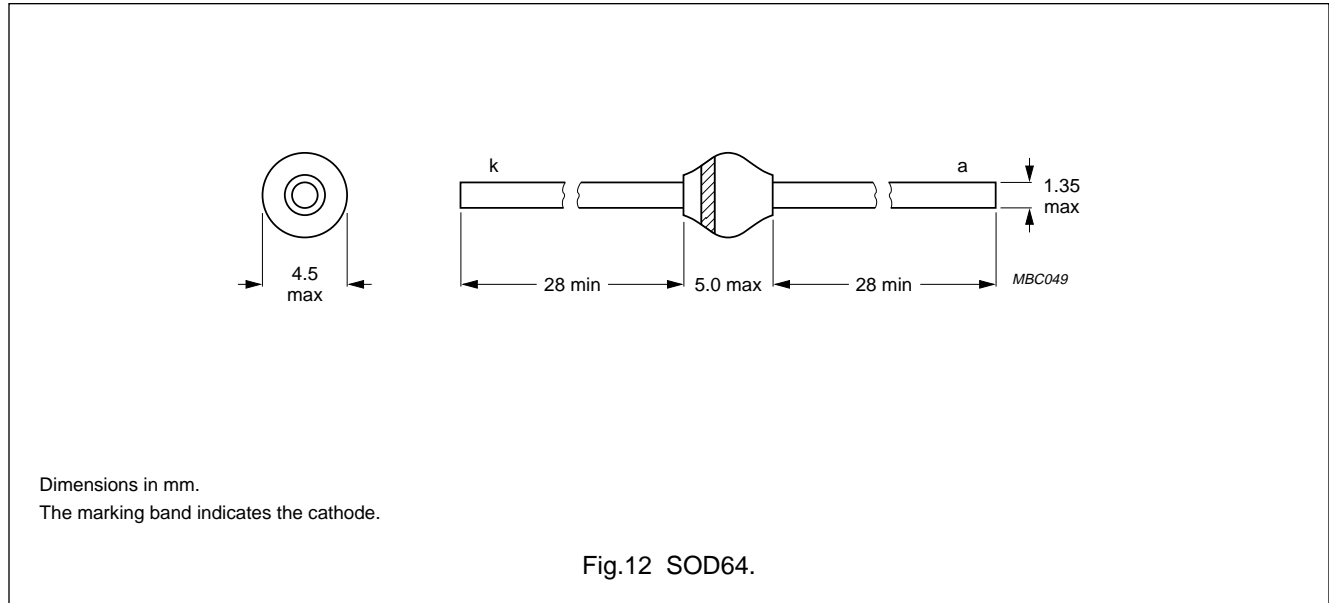

DEFINITIONS

<b>Data Sheet Status</b>	
Objective specification	This data sheet contains target or goal specifications for product development.
Preliminary specification	This data sheet contains preliminary data; supplementary data may be published later.
Product specification	This data sheet contains final product specifications.
<b>Limiting values</b>	
Limiting values given are in accordance with the Absolute Maximum Rating System (IEC 134). Stress above one or more of the limiting values may cause permanent damage to the device. These are stress ratings only and operation of the device at these or at any other conditions above those given in the Characteristics sections of the specification is not implied. Exposure to limiting values for extended periods may affect device reliability.	
<b>Application information</b>	
Where application information is given, it is advisory and does not form part of the specification.	

LIFE SUPPORT APPLICATIONS

These products are not designed for use in life support appliances, devices, or systems where malfunction of these products can reasonably be expected to result in personal injury. Philips customers using or selling these products for use in such applications do so at their own risk and agree to fully indemnify Philips for any damages resulting from such improper use or sale.