

GTLP17T616 17-Bit LVTTTL/GTLP Bus Transceiver with Buffered Clock

General Description

The GTLP17T616 is a 17-bit registered bus transceiver that provides LVTTTL to GTLP signal level translation. It allows for transparent, latched and clocked modes of data flow and provides a buffered GTLP (CLKOUT) clock output from the LVTTTL CLKAB. The device provides a high speed interface between cards operating at LVTTTL logic levels and a backplane operating at GTLP logic levels. High speed backplane operation is a direct result of GTLP's reduced output swing (<1V), reduced input threshold levels and output edge rate control. The edge rate control minimizes bus settling time. GTLP is a Fairchild Semiconductor derivative of the Gunning Transistor logic (GTL) JEDEC standard JESD8-3.

Fairchild's GTLP has internal edge-rate control and is Process, Voltage, and Temperature (PVT) compensated. Its function is similar to BTL or GTL but with different output levels and receiver thresholds. GTLP output LOW level is typically less than 0.5V, the output level HIGH is 1.5V and the receiver threshold is 1.0V.

Features

- Bidirectional interface between GTLP and LVTTTL logic levels
- Edge Rate Control to minimize noise on the GTLP port
- Power up/down high impedance for live insertion
- External V_{REF} pin for receiver threshold adjustability
- BiCMOS technology for low power dissipation
- Bushold data inputs on A Port eliminates the need for external pull-up resistors for unused inputs
- LVTTTL compatible Driver and Control inputs
- Flow-through architecture optimizes PCB layout
- Open drain on GTLP to support wired-or connection
- A Port source/sink -24 mA/+24 mA
- B Port sink capability +50 mA
- D-type flip-flop, latch and transparent data paths
- GTLP Buffered CLKAB signal available (CLKOUT)
- -40°C to +85°C Temperature operation

Ordering Code:

Order Number	Package Number	Package Description
GTLP17T616MEA	MS56A	56-Lead Shrink Small Outline Package (SSOP), JEDEC MO-118, 0.300" Wide
GTLP17T616MTD	MTD56	56-Lead Thin Shrink Small Outline Package (TSSOP), JEDEC MO-153, 6.1mm Wide

Device also available in Tape and Reel. Specify by appending suffix letter "X" to the ordering code.

GTLP17T616 17-Bit LVTTTL/GTLP Bus Transceiver with Buffered Clock

Pin Descriptions

Pin Names	Description
\overline{OEAB}	A-to-B Output Enable (Active LOW) (LVTTTL levels)
\overline{OEBA}	B-to-A Output Enable (Active LOW) (LVTTTL levels)
\overline{CEAB}	A-to-B Clock/LE Enable (Active LOW) (LVTTTL levels)
\overline{CEBA}	B-to-A Clock/LE Enable (Active LOW) (LVTTTL levels)
LEAB	A-to-B Latch Enable (Transparent HIGH) (LVTTTL levels)
LEBA	B-to-A Latch Enable (Transparent HIGH) (LVTTTL levels)
V_{REF}	GTLP Input Threshold Reference Voltage
CLKAB	A-to-B Clock (LVTTTL levels)
CLKBA	B-to-A Clock (LVTTTL levels)
A1–A17	A-to-B Data Inputs or B-to-A 3-STATE Outputs
B1–B17	B-to-A Data Inputs or A-to-B Open Drain Outputs (GTLP Levels)
CLKIN	B-to-A Buffered Clock Output (LVTTTL levels)
CLKOUT	GTLP Buffered Clock Input/Output of CLKAB (GTLP Levels)

Connection Diagram

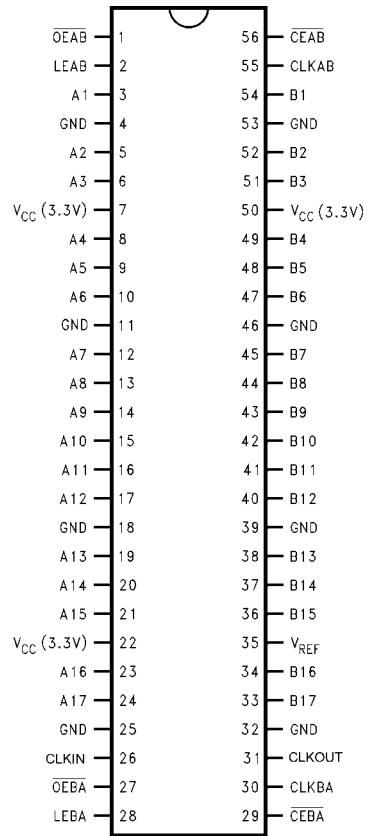

Truth Table (Note 1)

Inputs					Output B	Mode
\overline{CEAB}	\overline{OEAB}	LEAB	CLKAB	A		
X	H	X	X	X	Z	Latched
L	L	L	H or L	X	B_0 (Note 2)	storage of A data
L	L	L	H or L	X	B_0 (Note 3)	
X	L	H	X	L	L	Transparent
X	L	H	X	H	H	
L	L	L	↑	L	L	Clocked storage of A data
L	L	L	↑	H	H	
H	L	L	X	X	B_0 (Note 3)	Clock inhibit

Note 1: A-to-B data flow is shown. B-to-A data flow is similar but uses \overline{OEBA} , LEBA, CLKBA, and \overline{CEBA} .

Note 2: Output level before the indicated steady state input conditions were established, provided that CLKAB was HIGH before LEAB went LOW.

Note 3: Output level before the indicated steady-state input conditions were established.

Functional Description

The GTLP17T616 is a 17 bit registered transceiver containing D-type flip-flop, latch and transparent modes of operation for the data path and a GTLP translation of the CLKAB signal (CLKOUT). Data flow in each direction is controlled by the clock enables (CEAB and CEBA), latch enables (LEAB and LEBA), clock (CLKAB and CLKBA) and output enables (OEAB and OEBA). The clock enables (CEAB and CEBA) enable all 17 bits. The output enables (OEAB and OEBA) control the 17 bits of data and the CLKOUT/CLKIN buffered clock path. For A-to-B data flow, when \overline{CEAB} is low, the device operates on the LOW-to-HIGH transition of CLKAB for the flip-flop and on the HIGH-to-LOW transition of LEAB for the latch path. That is, if \overline{CEAB} is LOW and LEAB is LOW the A data is latched regardless as to the state of CLKAB (HIGH or LOW) and if LEAB is HIGH the device is in transparent mode. When OEAB is LOW the outputs are active. When OEAB is HIGH the outputs are high impedance. The data flow of B-to-A is similar except that CEBA, OEBA, LEBA and CLKBA are used.

Logic Diagram

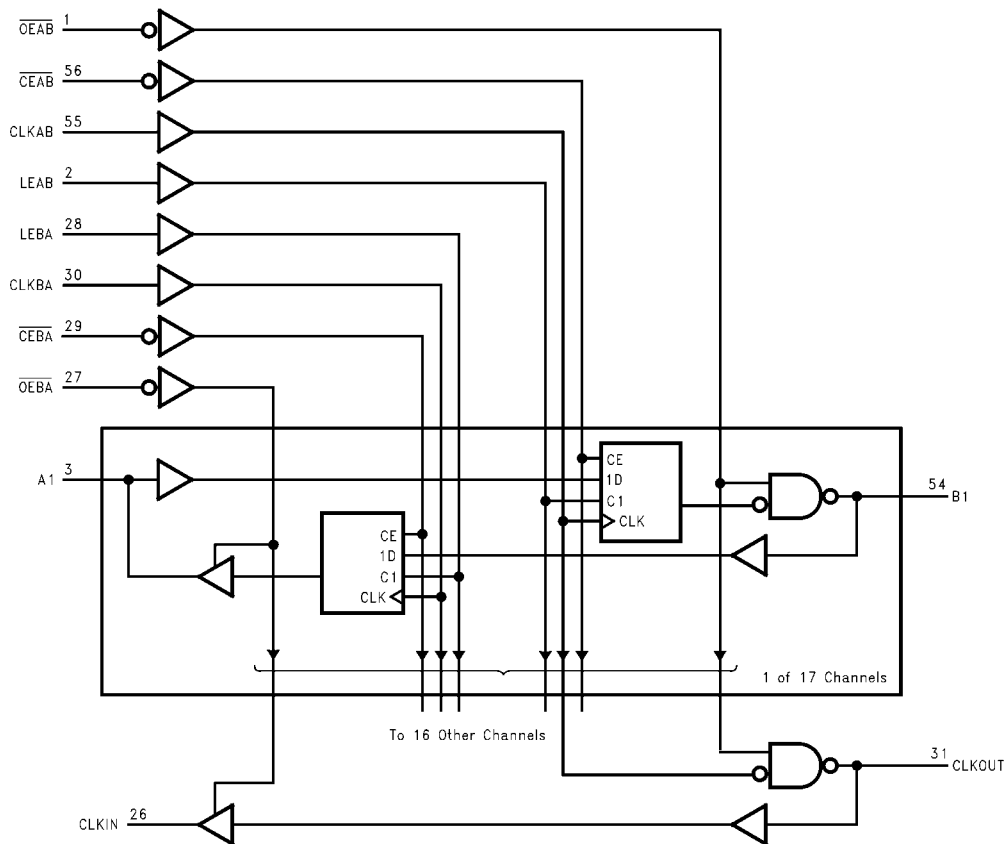

Absolute Maximum Ratings (Note 4)		Recommended Operating Conditions	
Supply Voltage (V_{CC})	-0.5V to +4.6V	Supply Voltage V_{CC}/V_{CCQ}	3.15V to 3.45V
DC Input Voltage (V_I)	-0.5V to +4.6V	Bus Termination Voltage (V_{TT})	
DC Output Voltage (V_O)		GTLP	1.47V to 1.53V
Outputs 3-STATE	-0.5V to +4.6V	V_{REF}	0.98V to 1.02V
Outputs Active (Note 5)	-0.5V to +4.6V	Input Voltage (V_I)	
DC Output Sink Current into		on A Port and Control Pins	0.0V to V_{CC}
A Port I_{OL}	48 mA	on B Port	0.0V to V_{CC}
DC Output Source Current from		HIGH Level Output Current (I_{OH})	
A Port I_{OH}	-48 mA	A Port	-24 mA
DC Output Sink Current into		LOW Level Output Current (I_{OL})	
B Port in the LOW State, I_{OL}	100 mA	A Port	+24 mA
DC Input Diode Current (I_{IK})		B Port	+50 mA
$V_I < 0V$	-50 mA	Operating Temperature (T_A)	-40°C to +85°C
DC Output Diode Current (I_{OK})		Note 4: Absolute Maximum continuous ratings are those values beyond which damage to the device may occur. Exposure to these conditions or conditions beyond those indicated may adversely affect device reliability. Functional operation under absolute maximum rated conditions is not implied.	
$V_O < 0V$	-50 mA	Note 5: I_O Absolute Maximum Rating must be observed.	
ESD Rating	>2000V		
Storage Temperature (T_{STG})	-65°C to +150°C		

DC Electrical Characteristics

Over Recommended Operating Free-Air Temperature Range, $V_{REF} = 1.0V$ (unless otherwise noted).

Symbol		Test Conditions		Min	Typ (Note 6)	Max	Units
V_{IH}	B Port			$V_{REF} + 0.05$		V_{TT}	V
	Others			2.0			
V_{IL}	B Port			0.0		$V_{REF} - 0.05$	V
	Others					0.8	
V_{REF}	B Port	$V_{TT} > V_{REF} + 50\text{ mV}$		0.25	1.0	$V_{CC} - 1.2V$	V
V_{TT}	B Port	$V_{TT} > V_{REF} + 50\text{ mV}$		$V_{REF} + 50\text{ mV}$	1.5	V_{CC}	
V_{IK}		$V_{CC} = 3.15V$	$I_I = -18\text{ mA}$			-1.2	V
V_{OH}	A Port	$V_{CC} = \text{Min to Max (Note 7)}$	$I_{OH} = -100\text{ }\mu\text{A}$	$V_{CC} - 0.2$			V
		$V_{CC} = 3.15V$	$I_{OH} = -18\text{ mA}$	2.4			
			$I_{OH} = -24\text{ mA}$	2.2			
V_{OL}	A Port	$V_{CC} = \text{Min to Max (Note 7)}$	$I_{OL} = 100\text{ }\mu\text{A}$			0.2	V
		$V_{CC} = 3.15V$	$I_{OL} = 24\text{ mA}$			0.5	
	B Port	$V_{CC} = 3.15V$	$I_{OL} = 40\text{ mA}$			0.4	V
			$I_{OL} = 50\text{ mA}$			0.55	
I_I	Control Pins	$V_{CC} = \text{Min to Max (Note 7)}$	$V_I = 3.45V\text{ or }0V$			± 5	μA
	A Port	$V_{CC} = 3.45V$	$V_I = 3.45V\text{ or }0V$			± 10	μA
	B Port	$V_{CC} = 3.45V$	$V_I = 0\text{ to }3.45V$			± 5	μA
$I_{PU/PD}$	All Ports	$V_{CC} = 0\text{ to }1.5V$	$V_I/V_O = 0\text{ to }3.45V$			± 30	μA
I_{OFF}	All Ports	$V_{CC} = 0$	$V_I\text{ or }V_O = 0\text{ to }3.45V$			30	μA
$I_{I(\text{hold})}$	A Port	$V_{CC} = 3.15V$	$V_I = 0.8V$	75			μA
			$V_I = 2.0V$			-75	
I_{OZH}	A Port	$V_{CC} = 3.45V$	$V_O = 3.45V$			10	μA
	B Port		$V_O = 1.5V$			5	
I_{OZL}	A Port	$V_{CC} = 3.45V$	$V_O = 0V$			-10	μA
	B Port		$V_O = 0.55V$			-5	
I_{CC} (V_{CC}/V_{CCQ})	A or B Ports	$V_{CC} = 3.45V$ $I_O = 0$ $V_I = V_{CC}\text{ or GND}$	Outputs HIGH			45	mA
			Outputs LOW			45	
			Outputs Disabled			45	
ΔI_{CC} (Note 8)	A Port and Control Pins	$V_{CC} = 3.45V$, A or Control Inputs at V_{CC} or GND	One Input at 2.7V		0	2	mA

DC Electrical Characteristics (Continued)						
Symbol		Test Conditions	Min	Typ (Note 6)	Max	Units
C _i	Control Pins	V _I = V _{CC} or 0			5.0	pF
	A Port	V _I = V _{CC} or 0			7.0	
	B Port	V _I = V _{CC} or 0			9.0	
<p>Note 6: All typical values are at V_{CC} = 3.3V, V_{CCQ} = 3.3V, and T_A = 25°C.</p> <p>Note 7: For conditions shown as Min or Max, use the appropriate value specified under recommended operating conditions.</p> <p>Note 8: This is the increase in supply current for each input that is at the specified TTL voltage level rather than V_{CC} or GND.</p>						
AC Operating Requirements						
Over recommended ranges of supply voltage and operating free-air temperature, V _{REF} = 1.0V (unless otherwise noted).						
Symbol		Test Conditions	Min	Max	Unit	
f _{TOGGLE}	Max Toggle Frequency	Transparent Mode	125		MHz	
f _{MAX}	Max Clock Frequency	Registered Mode	125			
t _{WIDTH}	Pulse Duration	LEAB or LEBA HIGH	3.0		ns	
		CLKAB or CLKBA HIGH or LOW	3.0			
t _{SU}	Setup Time	A before CLKAB↑	0.6		ns	
		B before CLKBA↑	1.2			
		A before LEAB↑	0.5			
		B before LEBA↑	1.3			
		$\overline{\text{CEAB}}$ before CLKAB↑	1.4			
		$\overline{\text{CEBA}}$ before CLKBA↑	1.2			
t _{HOLD}	Hold Time	A after CLKAB↑	0		ns	
		B after CLKBA↑	0.2			
		A after LEAB↑	0.2			
		B after LEBA↑	0			
		$\overline{\text{CEAB}}$ after CLKAB↑	0.5			
		$\overline{\text{CEBA}}$ after CLKBA↑	0.6			

AC Electrical Characteristics

Over recommended range of supply voltage and operating free-air temperature, $V_{REF} = 1.0V$ (unless otherwise noted).
 $C_L = 30\text{ pF}$ for B Port and $C_L = 50\text{ pF}$ for A Port.

Symbol	From (Input)	To (Output)	Min	Typ (Note 9)	Max	Unit
t_{PLH} t_{PHL}	A	B	1.6 1.0	4.0 2.5	6.3 4.4	ns
t_{PLH} t_{PHL}	LEAB	B	1.5 0.9	3.9 2.3	6.3 4.2	ns
t_{PLH} t_{PHL}	CLKAB	B	1.6 1.0	4.0 2.4	6.3 4.0	ns
t_{PLH} t_{PHL}	CLKAB	CLKOUT	2.6 1.7	5.2 3.4	7.7 6.0	ns
t_{PLH} t_{PHL}	\overline{OEAB}	B or CLKOUT	1.1 1.0	4.3 2.0	6.5 4.3	ns
t_{RISE}	Transition time, B outputs (20% to 80%)			2.3		ns
t_{FALL}	Transition time, B outputs (80% to 20%)			1.6		
t_{RISE}	Transition Time, A outputs (10% to 90%)			2.3		ns
t_{FALL}	Transition Time, A outputs (90% to 10%)			2.3		
t_{PLH} t_{PHL}	B	A	1.7 1.7	2.9 3.2	4.5 5.8	ns
t_{PLH} t_{PHL}	LEBA	A	0.3 0.4	2.5 2.5	4.6 4.6	ns
t_{PLH} t_{PHL}	CLKBA	A	0.5 0.6	2.6 2.8	4.6 4.6	ns
t_{PLH} t_{PHL}	CLKOUT	CLKIN	1.2 2.2	2.4 3.5	5.3 5.3	ns
t_{PZH} , t_{PZL} t_{PHZ} , t_{PLZ}	\overline{OEBA}	A or CLKIN	0.3 0.3	2.8 2.5	5.2 5.2	ns

Note 9: All typical values are at $V_{CC} = 3.3V$, and $T_A = 25^\circ C$.

AC Extended Electrical Characteristics

Over recommended ranges of supply voltage and operating free-air temperature $V_{REF} = 1.0V$ (unless otherwise noted).
 $C_L = 30$ pF for B Port and $C_L = 50$ pF for A Port.

Symbol	From (Input)	To (Output)	Min	Typ (Note 10)	Max	Unit
t_{OSLH} (Note 11)	A	B		0.3	1.0	ns
t_{OSHL} (Note 11)				0.3	0.6	
t_{PVHL} (Note 12)(Note 13)	A	B			2.5	ns
t_{OSLH} (Note 11)	CLKAB	B		0.3	1.0	ns
t_{OSHL} (Note 11)				0.3	0.6	
t_{PVHL} (Note 12)(Note 13)	CLKAB	B			2.5	ns
t_{OSLH} (Note 11)	B	A		0.3	0.5	ns
t_{OSHL} (Note 11)				0.3	0.5	
t_{OST} (Note 11)	B	A		0.5	1.2	ns
t_{PV} (Note 12)	B	A			2.5	ns
t_{OSLH} (Note 11)	CLKBA	A		0.3	0.5	ns
t_{OSHL} (Note 11)				0.3	0.5	
t_{OST} (Note 11)	CLKBA	A		0.5	1.2	ns
t_{PV} (Note 12)	CLKBA	A			2.5	ns
t_{PVHL} (Note 11)(Note 12)	CLKAB	CLKOUT			2.8	ns
t_{PDELLH} (Note 14)	B	CLKOUT	0		1.7	ns
t_{PDELHL} (Note 14)			0		1.5	

Note 10: All typical values are at $V_{CC} = 3.3V$, and $T_A = 25^\circ C$.

Note 11: t_{OSHL}/t_{OSLH} and t_{OST} - Output to output skew is defined as the absolute value of the difference between the actual propagation delay for all outputs within the same packaged device. The specifications are given for specific worst case V_{CC} and temperature and apply to any outputs switching in the same direction either HIGH-to-LOW (t_{OSHL}) or LOW-to-HIGH (t_{OSLH}) or in opposite directions both HL and LH (t_{OST}). This parameter is guaranteed by design and statistical process distribution. Actual skew values between the GTLP outputs could vary on the backplane due to the loading and impedance seen by the device.

Note 12: t_{PV} - Part to part skew is defined as the absolute value of the difference between the actual propagation delay for all outputs from device to device. The parameter is specified for a specific worst case V_{CC} and temperature. This parameter is guaranteed by design and statistical process distribution. Actual skew values between the GTLP outputs could vary on the backplane due to the loading and impedance seen by the device.

Note 13: Due to the open drain structure on GTLP outputs t_{OST} and $t_{PV(LH)}$ in the A-to-B direction are not specified. Skew on these paths is dependent on the V_{TT} and R_T values on the backplane.

Note 14: t_{PDELLH} and t_{PDELHL} - B to CLKOUT propagation delay delta is defined as the difference between the CLKAB to CLKOUT propagation delay and the CLKAB to B propagation delays. This parameter is for a given device and is not meant to guarantee the delta between the CLKAB to CLKOUT propagation delays of one device and the CLKAB to B propagation delays of other devices. This parameter is guaranteed by design and statistical process distribution.

Test Circuits and Timing Waveforms

Test Circuit for A Outputs

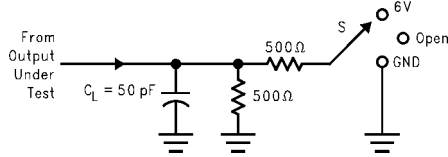

Test	S
t_{PLH}/t_{PHL}	OPEN
t_{PLZ}/t_{PZL}	6V
t_{PHZ}/t_{PZH}	GND

Note A: C_L includes probes and Jig capacitance.

Test Circuit for B Outputs

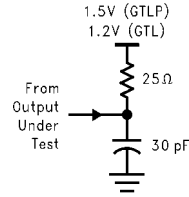

Note B: For B Port, $C_L = 30$ pF is used for worst case.

Voltage Waveform - Propagation Delay Times

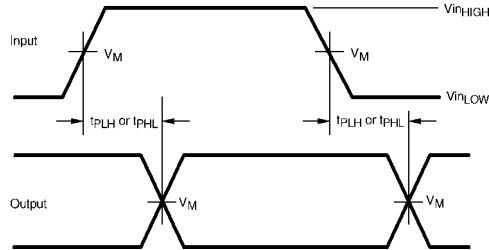

Voltage Waveform - Pulse Width

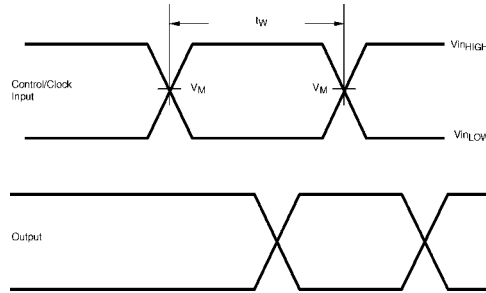

Voltage Waveform - Setup and Hold Times

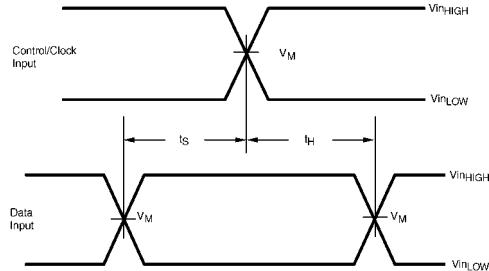

Voltage Waveform Enable and Disable times

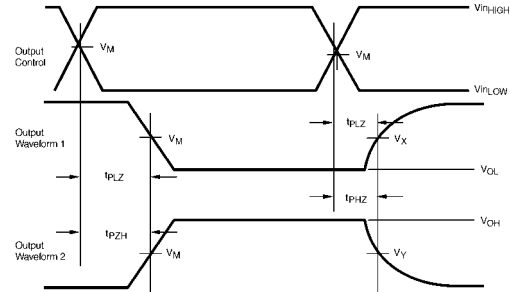

Output Waveform 1 is for an output with internal conditions such that the output is LOW except when disabled by the control output.
Output Waveform 2 is for an output with internal conditions such that the output is HIGH except when disabled by the control output.

Input and Measure Conditions

	A or LVTTL Pins	B or GTLP Pins
V_{inHIGH}	V_{CC}	1.5
V_{inLOW}	0.0	0.0
V_M	$V_{CC}/2$	1.0
V_X	$V_{OL} + 0.3V$	N/A
V_Y	$V_{OH} - 0.3V$	N/A

All input pulses have the following characteristics: Frequency = 10MHz, $t_{RISE} = t_{FALL} = 2$ ns (10% to 90%), $Z_0 = 50\Omega$
The outputs are measured one at a time with one transition per measurement.

Physical Dimensions inches (millimeters) unless otherwise noted

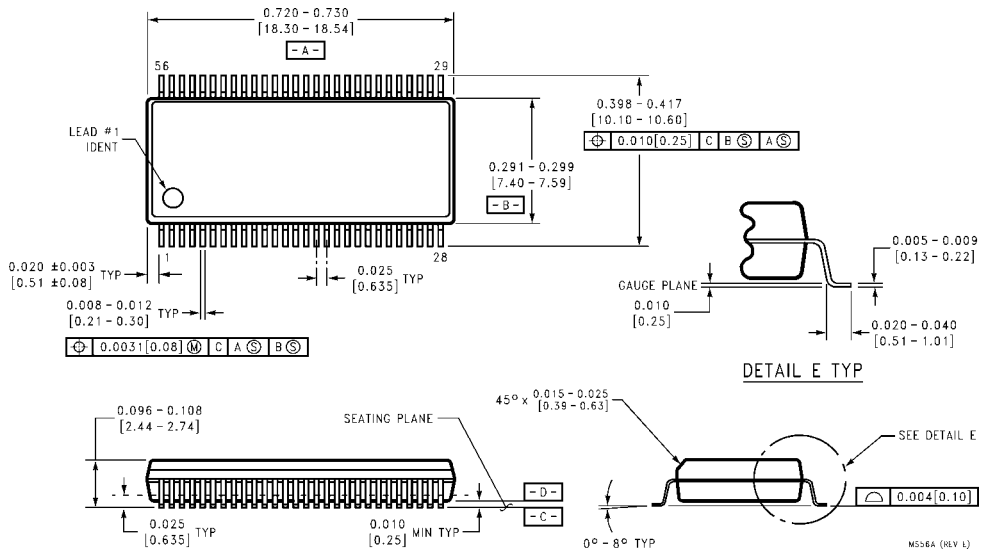

**56-Lead Shrink Small Outline Package (SSOP), JEDEC MO-118, 0.300" Wide
Package Number MS56A**

Physical Dimensions inches (millimeters) unless otherwise noted (Continued)

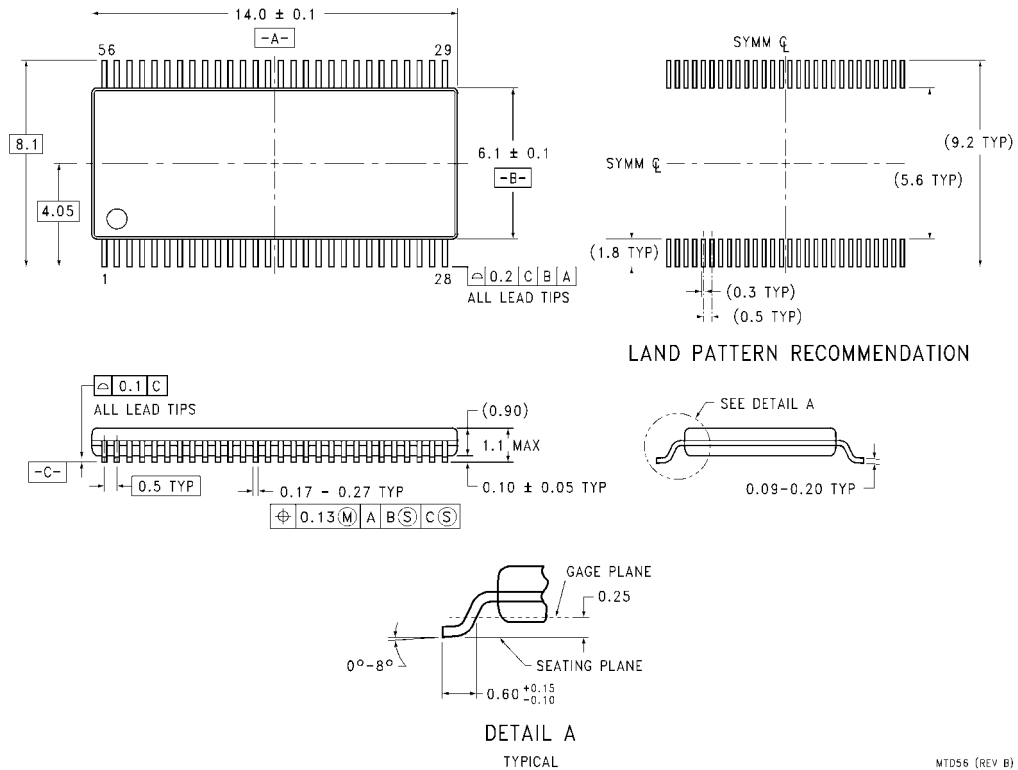

**56-Lead Thin Shrink Small Outline Package (TSSOP), JEDEC MO-153, 6.1mm Wide
Package Number MTD56**

Fairchild does not assume any responsibility for use of any circuitry described, no circuit patent licenses are implied and Fairchild reserves the right at any time without notice to change said circuitry and specifications.

LIFE SUPPORT POLICY

FAIRCHILD'S PRODUCTS ARE NOT AUTHORIZED FOR USE AS CRITICAL COMPONENTS IN LIFE SUPPORT DEVICES OR SYSTEMS WITHOUT THE EXPRESS WRITTEN APPROVAL OF THE PRESIDENT OF FAIRCHILD SEMICONDUCTOR CORPORATION. As used herein:

1. Life support devices or systems are devices or systems which, (a) are intended for surgical implant into the body, or (b) support or sustain life, and (c) whose failure to perform when properly used in accordance with instructions for use provided in the labeling, can be reasonably expected to result in a significant injury to the user.
2. A critical component in any component of a life support device or system whose failure to perform can be reasonably expected to cause the failure of the life support device or system, or to affect its safety or effectiveness.

www.fairchildsemi.com