

## Ultrafast Recovery Power Rectifier

### General Description

The SFN10A350D is ideally as boost diode in discontinuous or critical mode power factor corrections. The planar structure and the platinum doper life time control guarantee the best overall performance, ruggedness reliability characteristics. The device is also intended for use as a freewheeling diode in power supplies and other power switching applications.

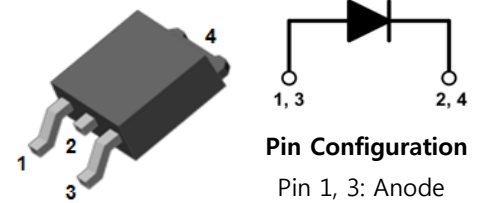

#### Pin Configuration

Pin 1, 3: Anode  
Pin 2, 4: Cathode

**TO-252**

### Features and Benefits

- Low forward drop voltage
- Ultrafast recovery time and high speed switching
- Full lead (Pb)-free device and RoHS compliant device

### Applications

- Switching power supply
- Power inverters
- Power conversion system

### Ordering Information

Part Number	Marking Code	Package	Packaging
<b>SFN10A350D</b>	<b>SFN10A350</b>	<b>TO-252</b>	<b>Tape &amp; Reel</b>

### Marking Information

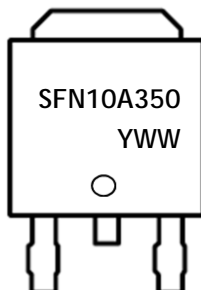

SFN10A350 = Specific Device Code  
YWW = Year & Week Code Marking  
-. Y = Year Code  
-. WW = Week Code

# SFN10A350D

## Absolute Maximum Ratings (Limiting values at 25°C, unless otherwise specified)

Characteristic	Symbol	Ratings	Unit
Maximum repetitive reverse voltage Maximum working peak reverse voltage Maximum DC blocking voltage	$V_{RRM}$ $V_{RWM}$ $V_R$	350	V
Maximum average forward rectified current	$I_{F(AV)}$	10	A
Peak forward surge current 8.3ms single half sine-wave superimposed on rated load	$I_{FSM}$	120	A
Storage temperature range	$T_{stg}$	-45 to +150	°C
Maximum operating junction temperature	$T_J$	150	

## Thermal Characteristics

Characteristic	Symbol	Ratings	Unit
Maximum thermal resistance	$R_{th(j-c)}$	4.0	°C/W

## Electrical Characteristics

Characteristic	Symbol	Test Condition	Min.	Typ.	Max.	Unit
Peak forward voltage drop	$V_{FM}^{1)}$	$I_{FM} = 10A$ $T_J = 25^\circ C$	-	1.15	1.35	V
Reverse leakage current	$I_{RM}^{2)}$	$V_R = V_{RRM}$ $T_J = 25^\circ C$	-	-	5	uA
			$T_J = 125^\circ C$	-	-	
Reverse recovery time	$t_{rr}$	$I_F = 1A, di/dt = -100 A/us$	-	20	25	ns
Junction capacitance	$C_j$	$V_R = 10V_{DC}, f=1MHz$	-	48	-	pF

<sup>1)</sup> Pulse test:  $t_p \leq 380us$ , Duty cycle  $\leq 2\%$

<sup>2)</sup> Pulse test:  $t_p \leq 20ms$ , Duty cycle  $\leq 2\%$

## Typical Electrical Characteristic Curves

Fig. 1) Typical Forward Characteristics

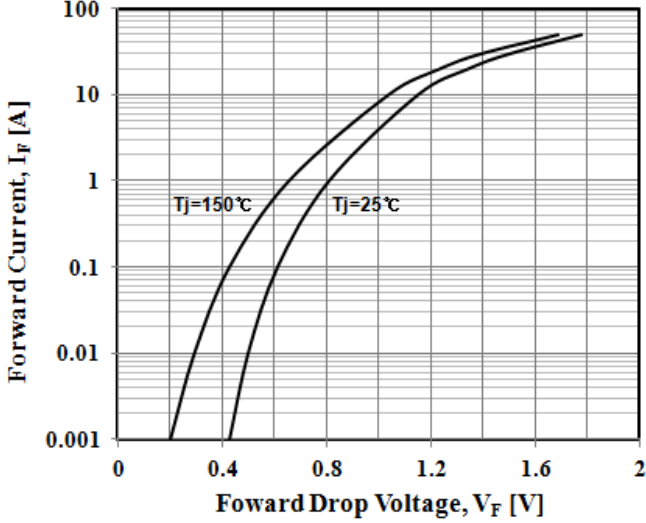

Fig. 2) Typical Reverse Characteristics

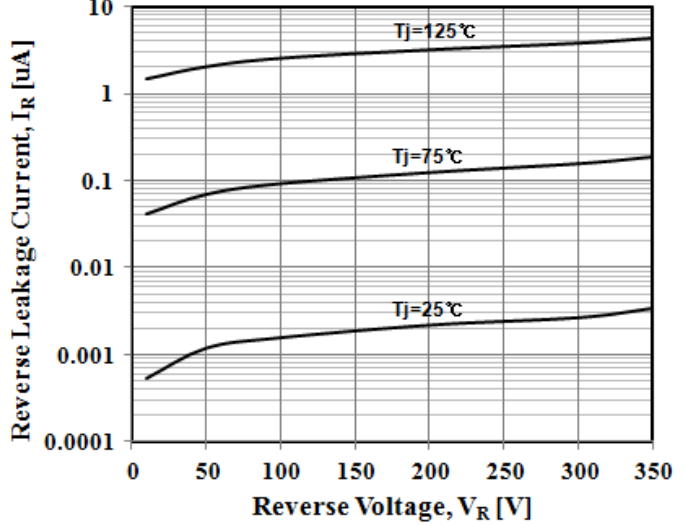

Fig. 3) Typical Junction Capacitance Characteristics

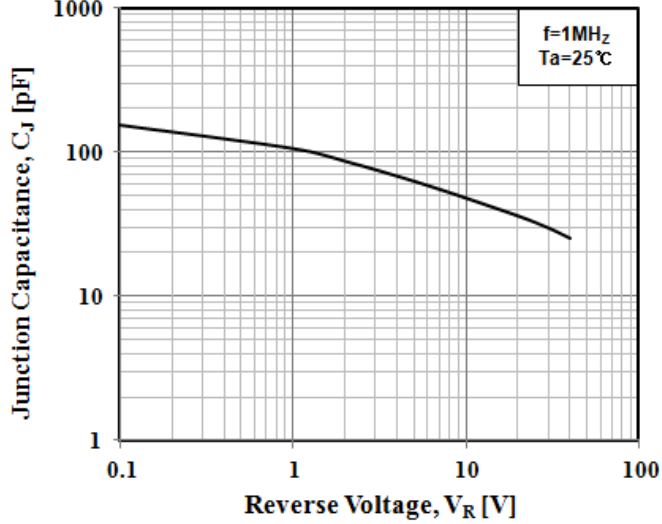

Fig. 4) Peak Forward Surge Current Characteristics

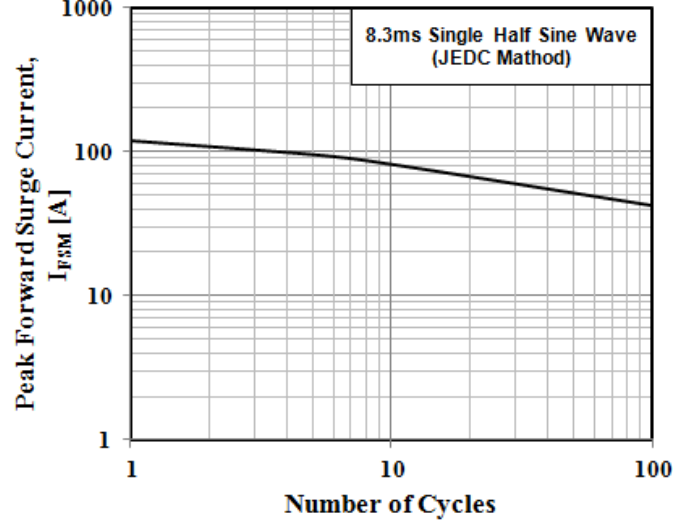

Fig. 5) Thermal Impedance Characteristics

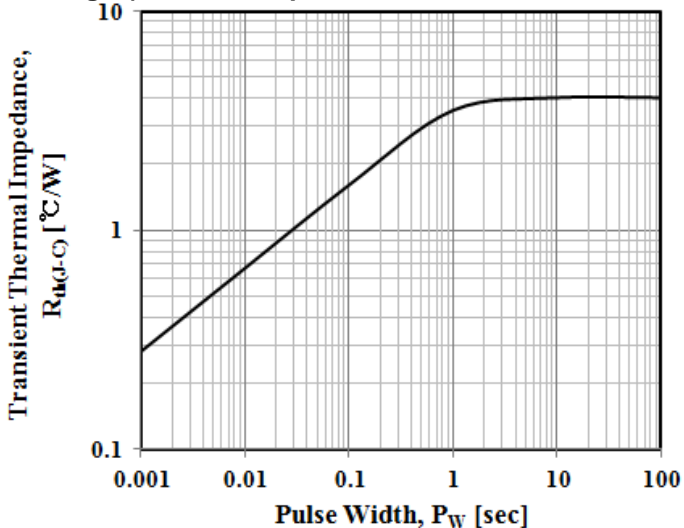
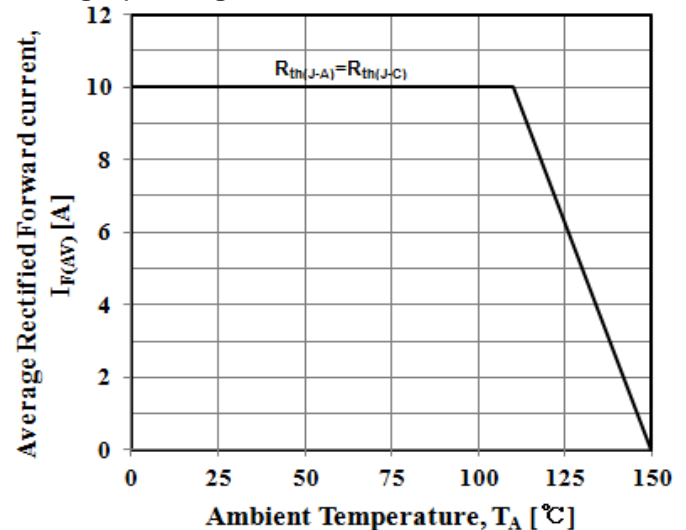
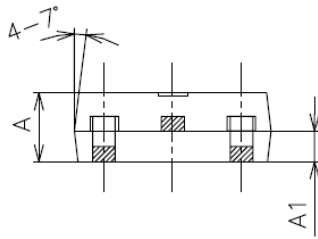
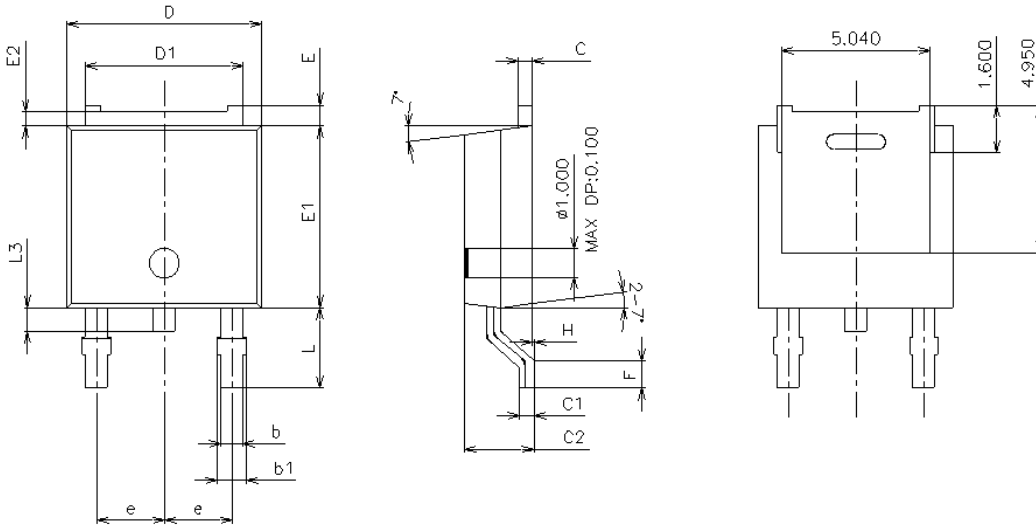

Fig. 6) Average Forward Current Characteristics



## Package Outline Dimensions (Unit: mm)



SYMBOL	MILLIMETERS			NOTE
	MINIMUM	NOMINAL	MAXIMUM	
D	6.40	6.60	6.80	
D1	5.14	5.34	5.54	
E	0.50	0.70	0.90	
E1	5.90	6.10	6.30	
E2	0.50 TYP			
A	2.20	2.30	2.40	
A1	0.87	1.07	1.27	
C	0.40	0.50	0.60	
C1	0.40	0.50	0.60	
C2	2.10	2.30	2.50	
L	2.50	2.70	2.90	
L3	0.60	0.80	1.00	
b	0.66	0.76	0.86	
b1	0.96 MAX			
e	2.10	2.30	2.50	
F	0.80 MIN			
H	0.00	-	0.10	

## ※ Recommended Land Pattern (Unit: mm)

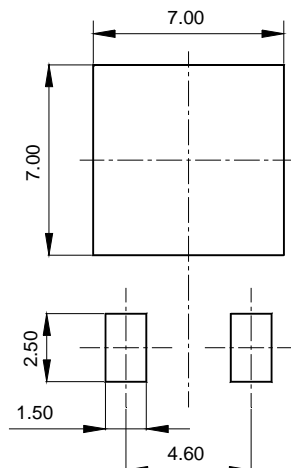

**The AUK Corp. products are intended for the use as components in general electronic equipment (Office and communication equipment, measuring equipment, home appliance, etc.).**

**Please make sure that you consult with us before you use these AUK Corp. products in equipments which require high quality and / or reliability, and in equipments which could have major impact to the welfare of human life(atomic energy control, airplane, spaceship, transportation, combustion control, all types of safety device, etc.). AUK Corp. cannot accept liability to any damage which may occur in case these AUK Corp. products were used in the mentioned equipments without prior consultation with AUK Corp..**

**Specifications mentioned in this publication are subject to change without notice.**