

## Optocoupler, Phototriac Output, Zero Crossing, High dV/dt, Low Input Current

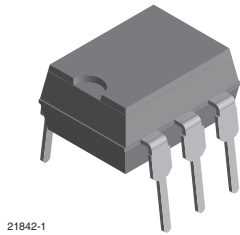

21842-1

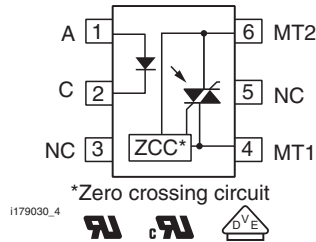

i179030\_4



### FEATURES

- High static dV/dt 5 kV/μs
- High input sensitivity I<sub>FT</sub> = 1.6 mA, 2 mA, and 3 mA
- 300 mA on-state current
- Zero voltage crossing detector
- 400 V and 600 V blocking voltage
- Isolation rated voltage 4420 V<sub>RMS</sub>
- Material categorization: for definitions of compliance please see [www.vishay.com/doc?99912](http://www.vishay.com/doc?99912)



**RoHS**  
COMPLIANT

### DESCRIPTION

The VO4154 and VO4156 consists of a GaAs IRLED optically coupled to a photosensitive zero crossing TRIAC packaged in a DIP-6 package.

High input sensitivity is achieved by using an emitter follower phototransistor and a cascaded SCR predriver resulting in an LED trigger current of 1.6 mA for bin D, 2 mA for bin H, and 3 mA for bin M.

The new phototriac zero crossing family uses a proprietary dV/dt clamp resulting in a static dV/dt of greater than 5 kV/μs.

The VO4154 and VO4156 isolates low-voltage logic from 120 V<sub>AC</sub>, 240 V<sub>AC</sub>, and 380 V<sub>AC</sub> lines to control resistive, inductive, or capacitive loads including motors, solenoids, high current thyristors or TRIAC and relays.

### APPLICATIONS

- Solid-state relays
- Industrial controls
- Office equipment
- Consumer appliances

### AGENCY APPROVALS

- UL1577, file no. E52744, double protection
- cUL - file no. E52744, equivalent to CSA bulletin 5A
- DIN EN 60747-5-5 (VDE 0884-5), available with option 1

ORDERING INFORMATION							
<div style="display: flex; justify-content: space-around; border: 1px solid black; padding: 2px;"> <span>V</span><span>O</span><span>4</span><span>1</span><span>5</span><span>#</span><span>X</span><span>-</span><span>X</span><span>0</span><span>0</span><span>#</span><span>T</span> </div>			PART NUMBER		PACKAGE OPTION		
AGENCY CERTIFIED/PACKAGE		V <sub>DRM</sub> 400			V <sub>DRM</sub> 600		
TRIGGER CURRENT, I <sub>FT</sub> (mA)							
UL, cUL	1.6	2	3	1.6	2	3	
DIP-6	VO4154D	VO4154H	VO4154M	VO4156D	VO4156H	VO4156M	
DIP-6, 400 mil, option 6	VO4154D-X006	VO4154H-X006	VO4154M-X006	VO4156D-X006	VO4156H-X006	VO4156M-X006	
SMD-6, option 7	VO4154D-X007T	VO4154H-X007T	VO4154M-X007T	VO4156D-X007T	VO4156H-X007T <sup>(1)</sup>	VO4156M-X007T	
UL, cUL, VDE	1.6	2	3	1.6	2	3	
DIP-6, 400 mil, option 6	-	-	-	-	VO4156H-X016	-	
SMD-6, option 7	-	-	-	VO4156D-X017T	-	-	

#### Note

- Also available in tubes, do not put "T" to the end



ABSOLUTE MAXIMUM RATINGS (T <sub>amb</sub> = 25 °C, unless otherwise specified)					
PARAMETER	TEST CONDITION	PART	SYMBOL	VALUE	UNIT
<b>INPUT</b>					
Reverse voltage			V <sub>R</sub>	6	V
Forward current			I <sub>F</sub>	60	mA
Surge current			I <sub>FSM</sub>	2.5	A
Power dissipation			P <sub>diss</sub>	100	mW
Derate from 25 °C				1.33	mW/°C
<b>OUTPUT</b>					
Peak off-state voltage		VO4154D/H/M	V <sub>DRM</sub>	400	V
		VO4156D/H/M	V <sub>DRM</sub>	600	V
RMS on-state current			I <sub>TM</sub>	300	mA
Total power dissipation			P <sub>diss</sub>	500	mW
Derate from 25 °C				6.6	mW/°C
<b>COUPLER</b>					
Storage temperature range			T <sub>stg</sub>	-55 to +150	°C
Ambient temperature range			T <sub>amb</sub>	-55 to +100	°C
Soldering temperature	Max. ≤ 10 s dip soldering ≥ 0.5 mm from case bottom		T <sub>sld</sub>	260	°C

**Note**

- Stresses in excess of the absolute maximum ratings can cause permanent damage to the device. Functional operation of the device is not implied at these or any other conditions in excess of those given in the operational sections of this document. Exposure to absolute maximum ratings for extended periods of the time can adversely affect reliability

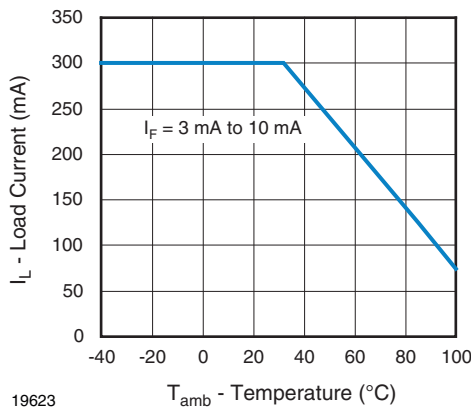
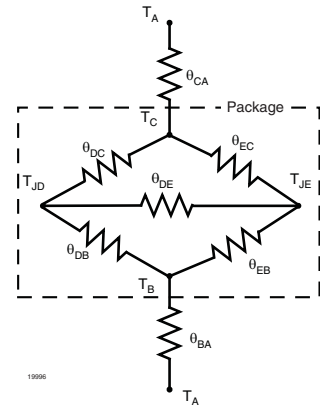

Fig. 1 - Recommended Operating Condition

THERMAL CHARACTERISTICS			
PARAMETER	SYMBOL	VALUE	UNIT
LED power dissipation	$P_{diss}$	100	mW
Output power dissipation	$P_{diss}$	500	mW
Maximum LED junction temperature	$T_{jmax.}$	125	°C
Maximum output die junction temperature	$T_{jmax.}$	125	°C
Thermal resistance, junction emitter to board	$\theta_{JEB}$	150	°C/W
Thermal resistance, junction emitter to case	$\theta_{JEC}$	139	°C/W
Thermal resistance, junction detector to board	$\theta_{JDB}$	78	°C/W
Thermal resistance, junction detector to case	$\theta_{JDC}$	103	°C/W
Thermal resistance, junction emitter to junction detector	$\theta_{JED}$	496	°C/W
Thermal resistance, case to ambient	$\theta_{CA}$	3563	°C/W



**Note**

- The thermal characteristics table above were measured at 25 °C and the thermal model is represented in the thermal network below. Each resistance value given in this model can be used to calculate the temperatures at each node for a given operating condition. The thermal resistance from board to ambient will be dependent on the type of PCB, layout and thickness of copper traces. For a detailed explanation of the thermal model, please reference Vishay's Thermal Characteristics of Optocouplers application note

ELECTRICAL CHARACTERISTICS ( $T_{amb} = 25\text{ °C}$ , unless otherwise specified)							
PARAMETER	TEST CONDITION	PART	SYMBOL	MIN.	TYP.	MAX.	UNIT
<b>INPUT</b>							
Forward voltage	$I_F = 10\text{ mA}$		$V_F$	-	1.2	1.4	V
Reverse current	$V_R = 6\text{ V}$		$I_R$	-	0.1	10	μA
Input capacitance	$V_F = 0\text{ V}, f = 1\text{ MHz}$		$C_i$	-	25	-	pF
<b>OUTPUT</b>							
Repetitive peak off-state voltage	$I_{DRM} = 100\text{ μA}$	VO4154D/H/M	$V_{DRM}$	400	-	-	V
		VO4156D/H/M	$V_{DRM}$	600	-	-	V
Off-state current	$V_D = V_{DRM}, I_F = 0\text{ A}$		$I_{DRM}$	-	-	100	μA
On-state voltage	$I_T = 300\text{ mA}$		$V_{TM}$	-	-	3	V
On-state current	$PF = 1, V_{T(RMS)} = 1.7\text{ V}$		$I_{TM}$	-	-	300	mA
Off-state current in inhibit state	$I_F = 2\text{ mA}, V_{DRM}$		$I_{DINH}$	-	-	200	μA
Holding current			$I_H$	-	-	500	μA
Zero cross inhibit voltage	$I_F = \text{rated } I_{FT}$		$V_{IH}$	-	-	20	V
Critical rate of rise of off-state voltage	$V_D = 0.67 V_{DRM}, T_J = 25\text{ °C}$		$dV/dt_{cr}$	5000	-	-	V/μs
Critical rate of rise of on-state			$dV/dt_{cr}$	8	-	-	A/μs
<b>COUPLER</b>							
LED trigger current, current required to latch output	$V_D = 3\text{ V}$	VO4154D	$I_{FT}$	-	-	1.6	mA
		VO4154H	$I_{FT}$	-	-	2	mA
		VO4154M	$I_{FT}$	-	-	3	mA
		VO4156D	$I_{FT}$	-	-	1.6	mA
		VO4156H	$I_{FT}$	-	-	2	mA
		VO4156M	$I_{FT}$	-	-	3	mA
Common mode coupling capacitance			$C_{CM}$	-	0.01	-	pF
Capacitance (input to output)	$f = 1\text{ MHz}, V_{IO} = 0\text{ V}$		$C_{IO}$	-	0.8	-	pF

**Note**

- Minimum and maximum values were tested requirements. Typical values are characteristics of the device and are the result of engineering evaluations. Typical values are for information only and are not part of the testing requirements



SAFETY AND INSULATION RATINGS				
PARAMETER	TEST CONDITION	SYMBOL	VALUE	UNIT
Climatic classification	According to IEC 68 part 1		55 / 100 / 21	
Comparative tracking index		CTI	175	
Maximum rated withstanding isolation voltage	t = 1 min	$V_{ISO}$	4420	$V_{RMS}$
Maximum transient isolation voltage		$V_{IOTM}$	8000	$V_{peak}$
Maximum repetitive peak isolation voltage		$V_{IORM}$	890	$V_{peak}$
Isolation resistance	$V_{IO} = 500\text{ V}, T_{amb} = 25\text{ }^{\circ}\text{C}$	$R_{IO}$	$\geq 10^{12}$	$\Omega$
	$V_{IO} = 500\text{ V}, T_{amb} = 100\text{ }^{\circ}\text{C}$	$R_{IO}$	$\geq 10^{11}$	$\Omega$
Output safety power		$P_{SO}$	500	mW
Input safety current		$I_{SI}$	250	mA
Safety temperature		$T_S$	175	$^{\circ}\text{C}$
Creepage distance			$\geq 7$	mm
Clearance distance			$\geq 7$	mm
Insulation thickness		DTI	$\geq 0.4$	mm
Pollution degree (DIN VDE 0109)			2	

**Note**

- As per IEC 60747-5-5, § 7.4.3.8.2, this optocoupler is suitable for “safe electrical insulation” only within the safety ratings. Compliance with the safety ratings shall be ensured by means of protective circuits.

**TYPICAL CHARACTERISTICS** ( $T_{amb} = 25\text{ }^{\circ}\text{C}$ , unless otherwise specified)

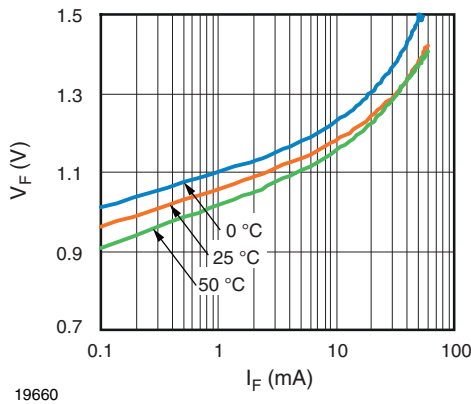

Fig. 2 - Diode Forward Voltage vs. Forward Current

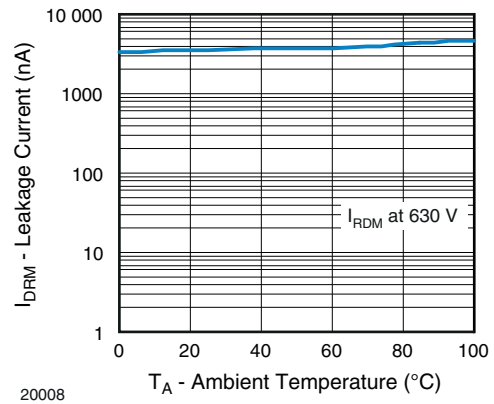

Fig. 4 - Leakage Current vs. Ambient Temperature

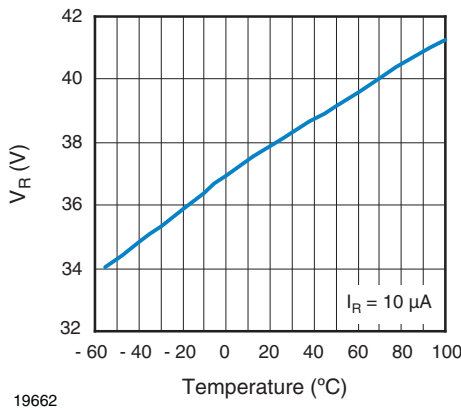

Fig. 3 - Diode Reverse Voltage vs. Temperature

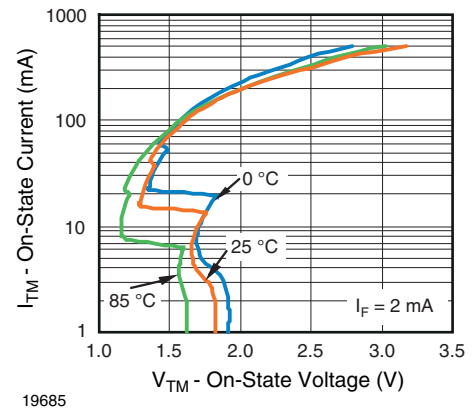

Fig. 5 - On-State Current vs. On-State Voltage

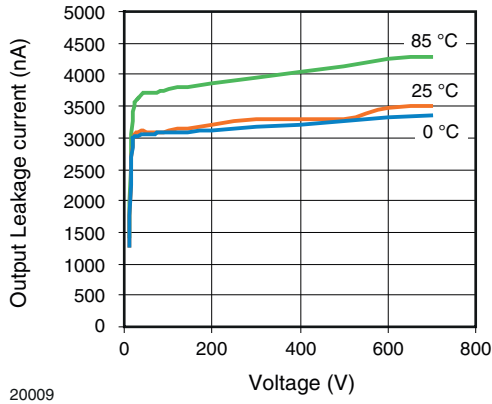

Fig. 6 - Output Off Current (Leakage) vs. Voltage

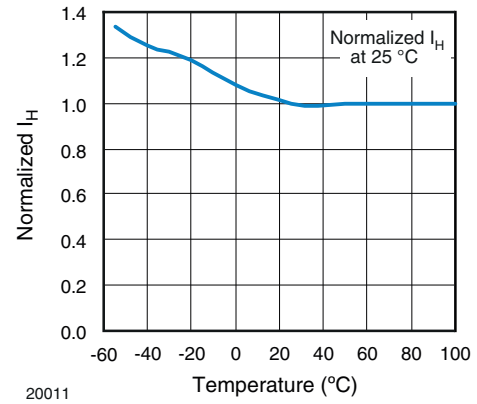

Fig. 9 - Normalized Holding Current vs. Temperature

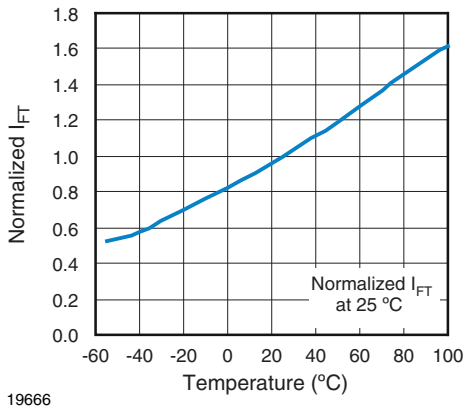

Fig. 7 - Normalized Trigger Input Current vs. Temperature

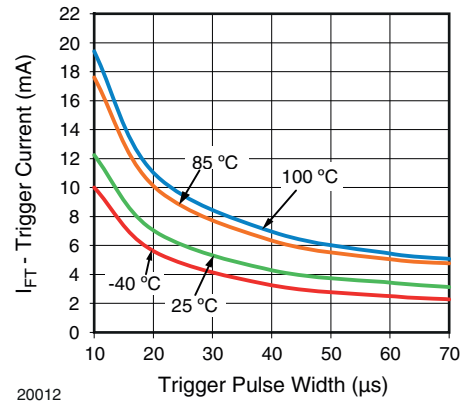

Fig. 10 -  $I_{FT}$  vs. LED Pulse Width

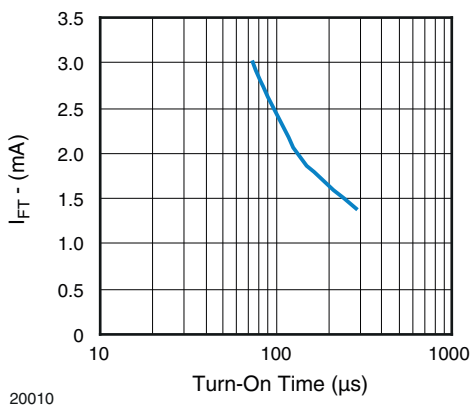
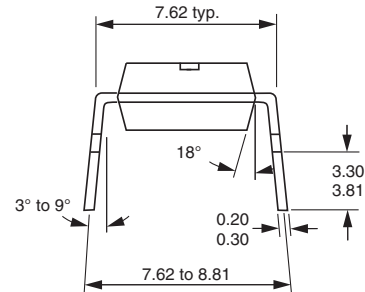
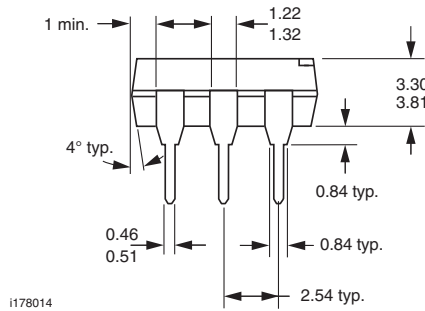
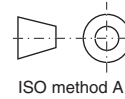
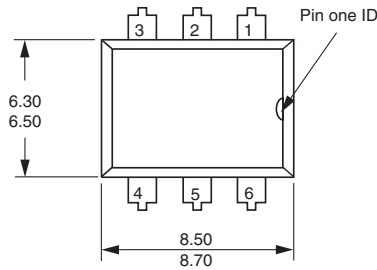

Fig. 8 -  $I_{FT}$  (mA) vs. Turn-On Time ( $\mu$ s)



PACKAGE DIMENSIONS in millimeters



i178014

Option 6

Option 7

Option 8

Option 9

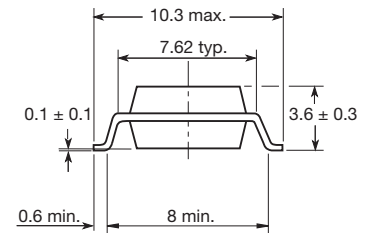
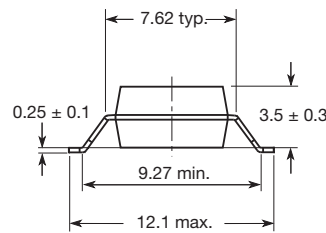
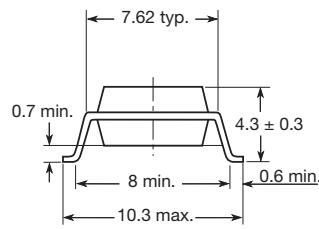
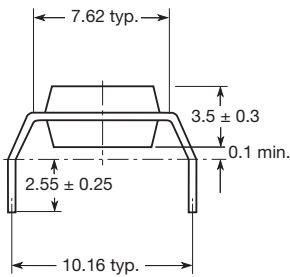

20802-50

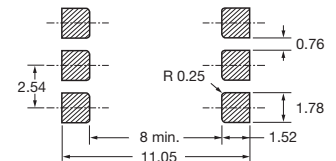
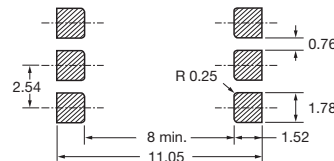
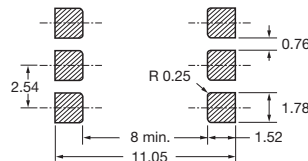

PACKAGE MARKING (example)



Notes

- Only options 1, 7, and 8 are reflected in the package marking
- The VDE Logo is only marked on option 1 parts
- Tape and reel suffix (T) is not part of the package marking



## **Disclaimer**

ALL PRODUCT, PRODUCT SPECIFICATIONS AND DATA ARE SUBJECT TO CHANGE WITHOUT NOTICE TO IMPROVE RELIABILITY, FUNCTION OR DESIGN OR OTHERWISE.

Vishay Intertechnology, Inc., its affiliates, agents, and employees, and all persons acting on its or their behalf (collectively, "Vishay"), disclaim any and all liability for any errors, inaccuracies or incompleteness contained in any datasheet or in any other disclosure relating to any product.

Vishay makes no warranty, representation or guarantee regarding the suitability of the products for any particular purpose or the continuing production of any product. To the maximum extent permitted by applicable law, Vishay disclaims (i) any and all liability arising out of the application or use of any product, (ii) any and all liability, including without limitation special, consequential or incidental damages, and (iii) any and all implied warranties, including warranties of fitness for particular purpose, non-infringement and merchantability.

Statements regarding the suitability of products for certain types of applications are based on Vishay's knowledge of typical requirements that are often placed on Vishay products in generic applications. Such statements are not binding statements about the suitability of products for a particular application. It is the customer's responsibility to validate that a particular product with the properties described in the product specification is suitable for use in a particular application. Parameters provided in datasheets and / or specifications may vary in different applications and performance may vary over time. All operating parameters, including typical parameters, must be validated for each customer application by the customer's technical experts. Product specifications do not expand or otherwise modify Vishay's terms and conditions of purchase, including but not limited to the warranty expressed therein.

Except as expressly indicated in writing, Vishay products are not designed for use in medical, life-saving, or life-sustaining applications or for any other application in which the failure of the Vishay product could result in personal injury or death. Customers using or selling Vishay products not expressly indicated for use in such applications do so at their own risk. Please contact authorized Vishay personnel to obtain written terms and conditions regarding products designed for such applications.

No license, express or implied, by estoppel or otherwise, to any intellectual property rights is granted by this document or by any conduct of Vishay. Product names and markings noted herein may be trademarks of their respective owners.